

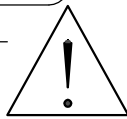

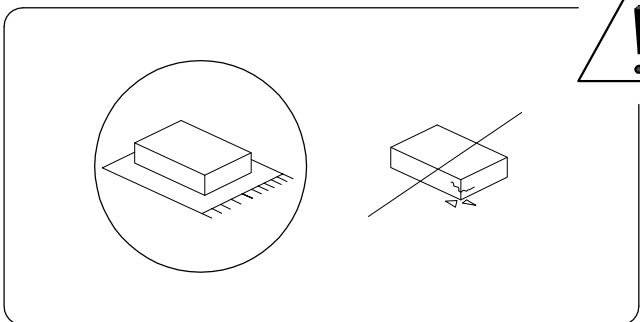

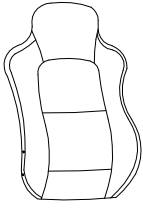

30'

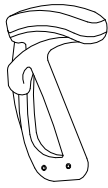

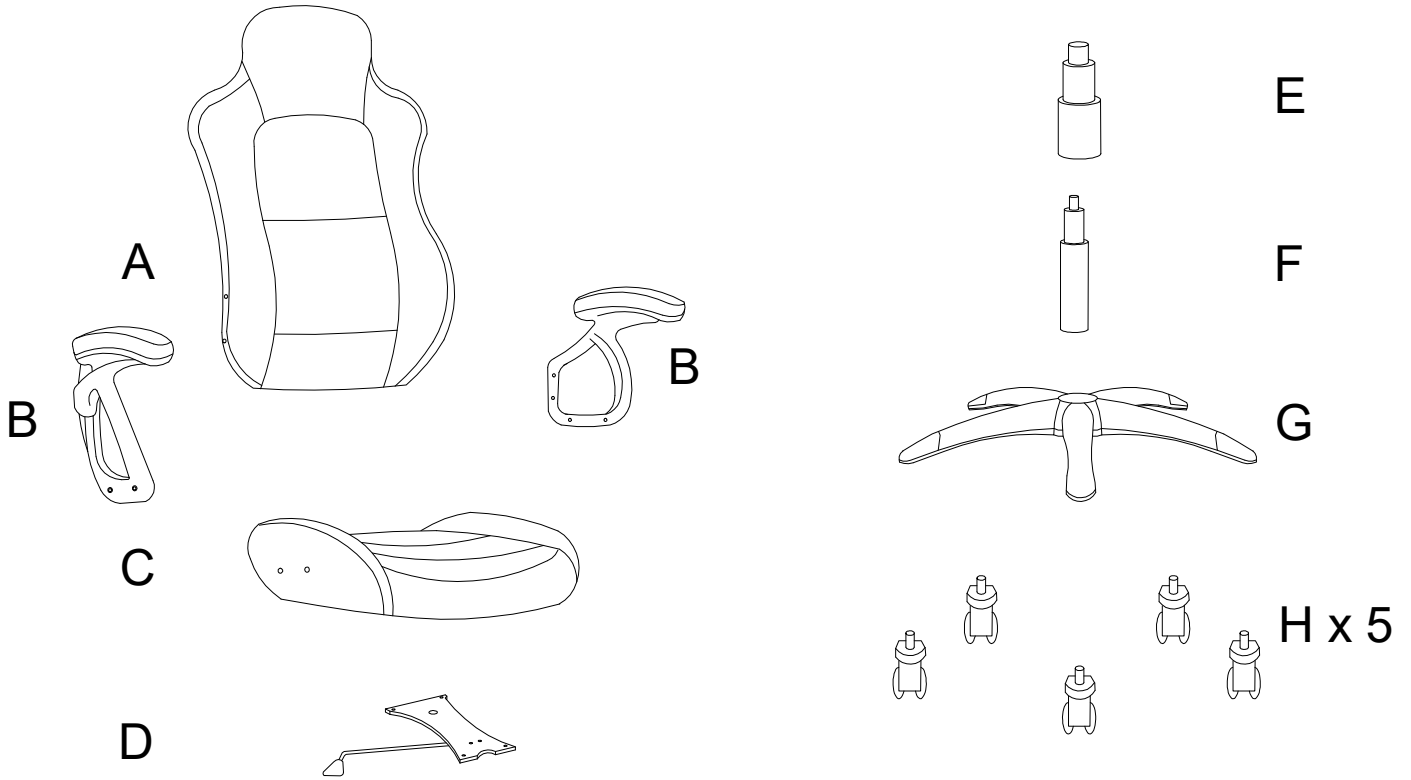
1

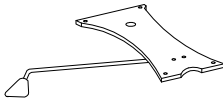
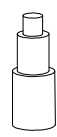
<p>A</p>  <p>x 1</p>	<p>B</p>  <p>x 2</p>	<p>C</p>  <p>x 1</p>
---	---	---

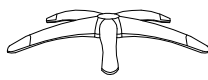

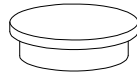
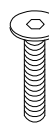
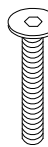
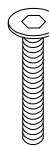
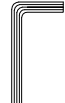
<p>D</p>  <p>x 1</p>	<p>E</p>  <p>x 1</p>	<p>F</p>  <p>x 1</p>	<p>G</p>  <p>x 1</p>	<p>H</p>  <p>x 5</p>
<p>I</p>  <p>x 8</p>	<p>J</p>  <p>M6 x 20</p> <p>x 2</p>	<p>K</p>  <p>M6 x 30</p> <p>x 2</p>	<p>L</p>  <p>M8 x 30</p> <p>x 8</p>	<p>M</p>  <p>x 1</p>



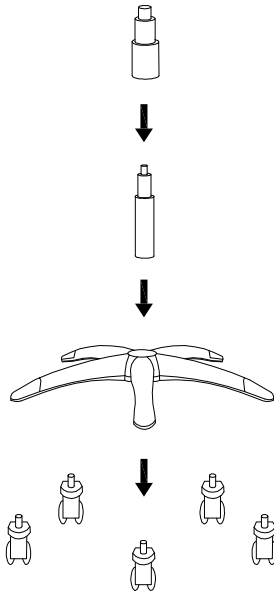
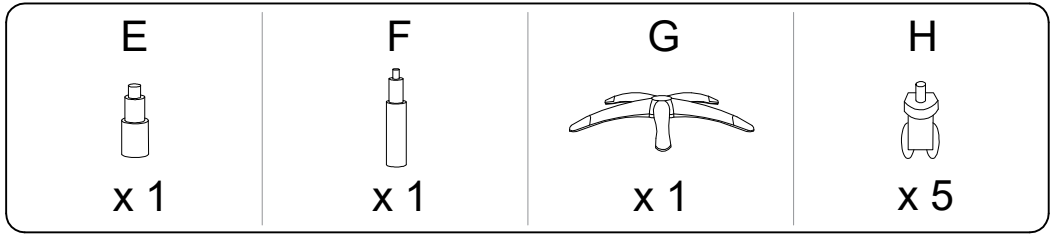

1

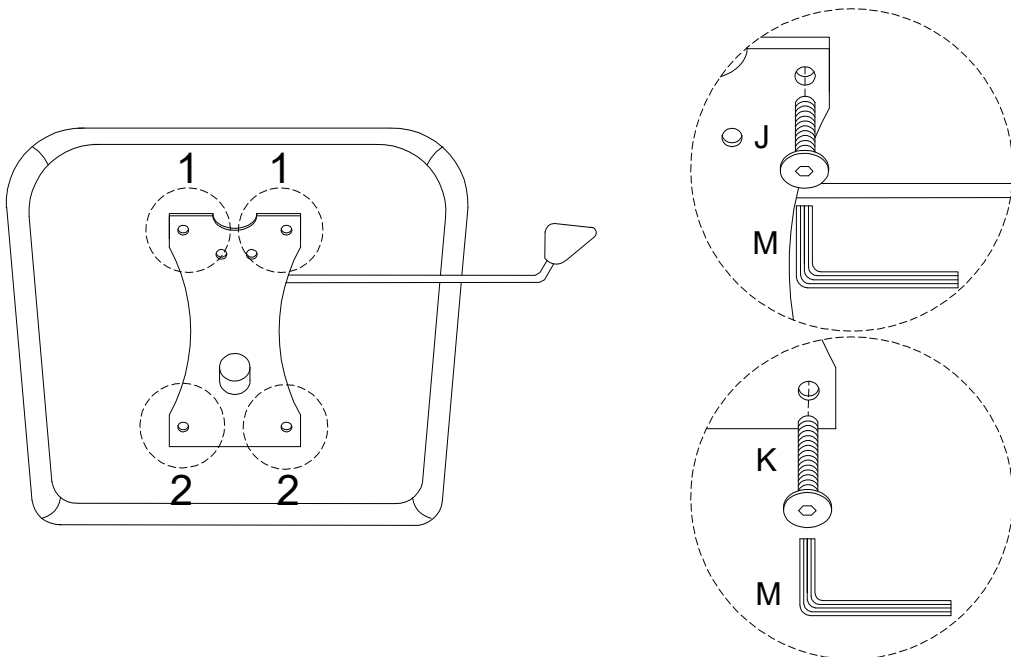
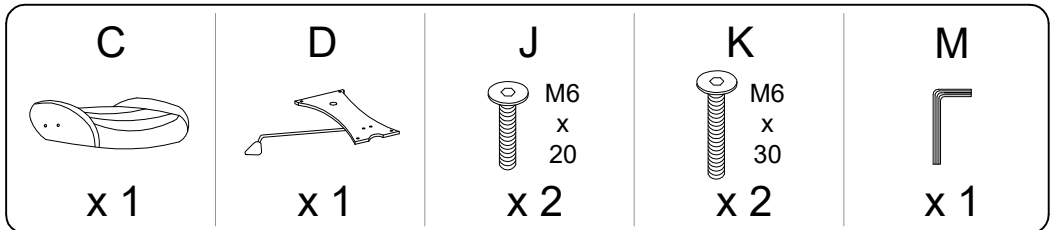

2

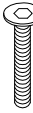

3

<p>B</p>  <p>x 2</p>	<p>I</p>  <p>x 8</p>	<p>L</p>  <p>M8 x 30</p> <p>x 8</p>	<p>M</p>  <p>x 1</p>
---	---	---	---

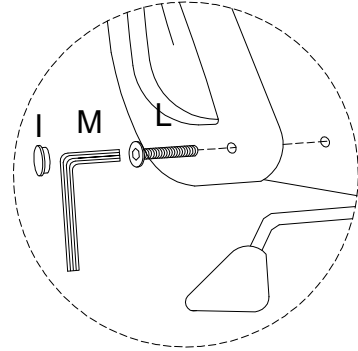
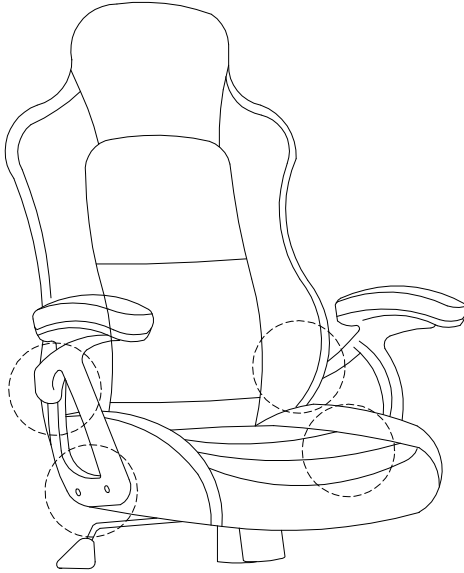

4

