

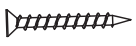

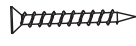



ASSEMBLY INSTRUCTIONS

 A M3.5*50 62PCS	 B M3.5*40 48PCS	 C M3.5*35 10PCS	 D M3.0*20 40PCS
 E M3.0*16 24PCS	 F M6.0*60 20PCS	 M3.0*16 4PCS 1PCS	 2PCS
 8PCS			

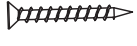

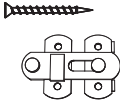
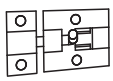
①x2

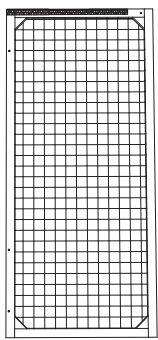
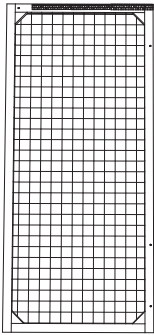

②x2

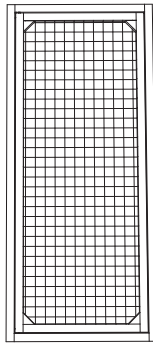

③

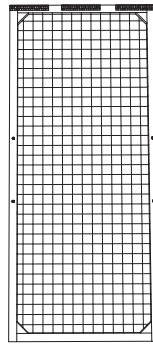

④

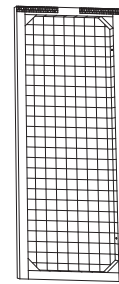

⑤

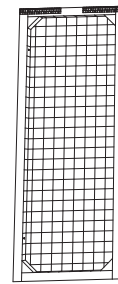

⑥

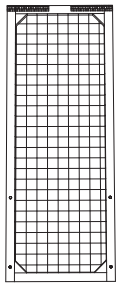

⑦x2

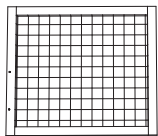

⑧x2

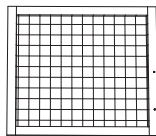

⑨

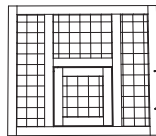

⑩

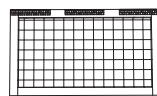

⑪

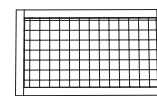

⑫

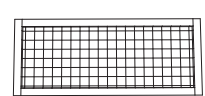

⑬x2

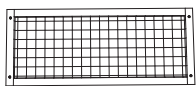

⑭

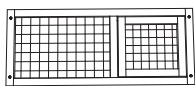

⑮



⑯x2



⑰x2

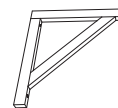

⑱x8

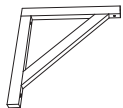

⑲x2

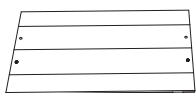

⑳



㉑x2

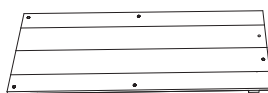

㉒x2

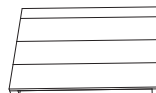

㉓x4

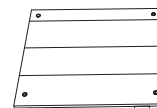

㉔x2

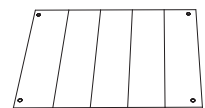

㉕x2



⑳x12



㉗x4



㉘x2

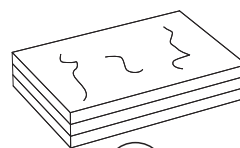

㉙

STEP 1

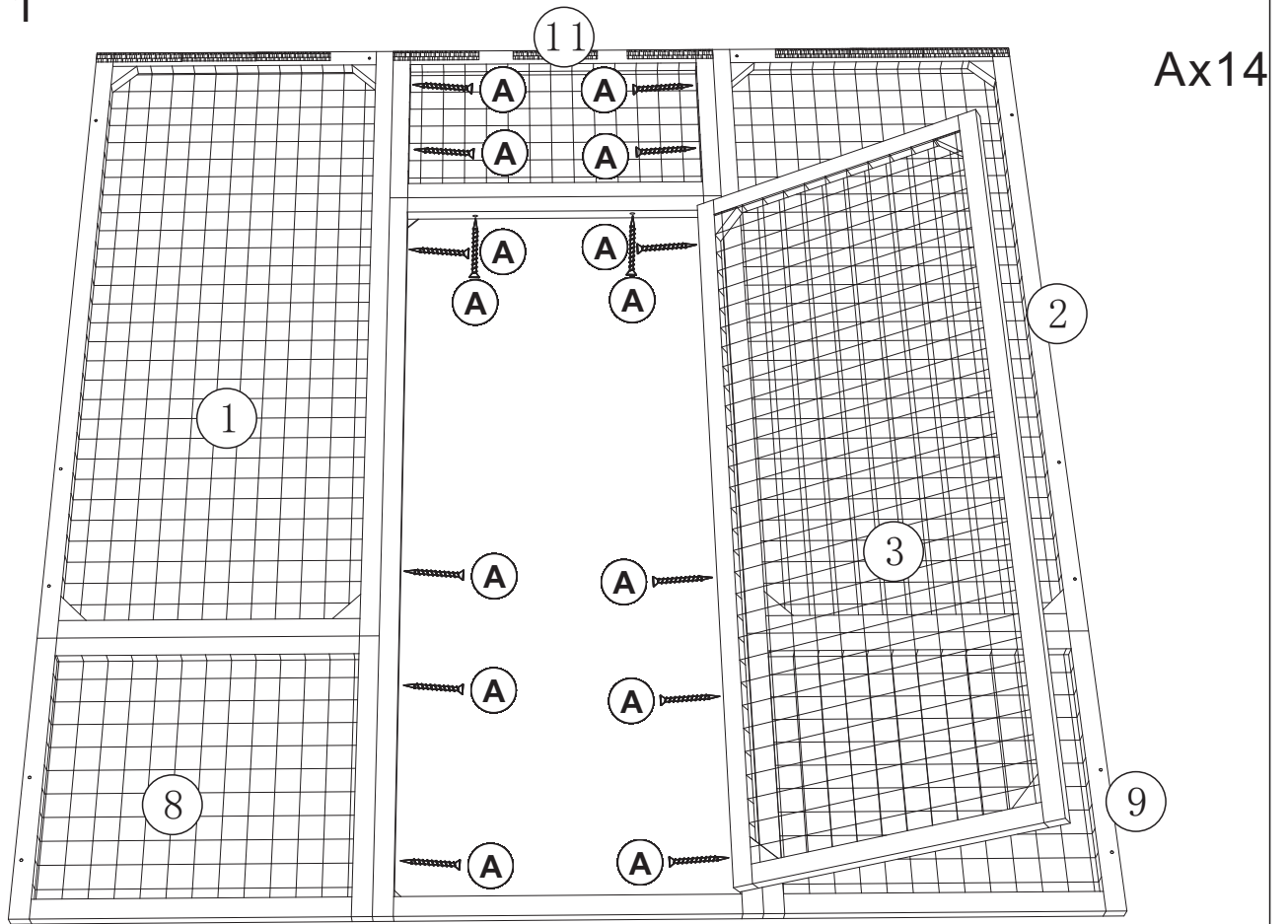

STEP 2

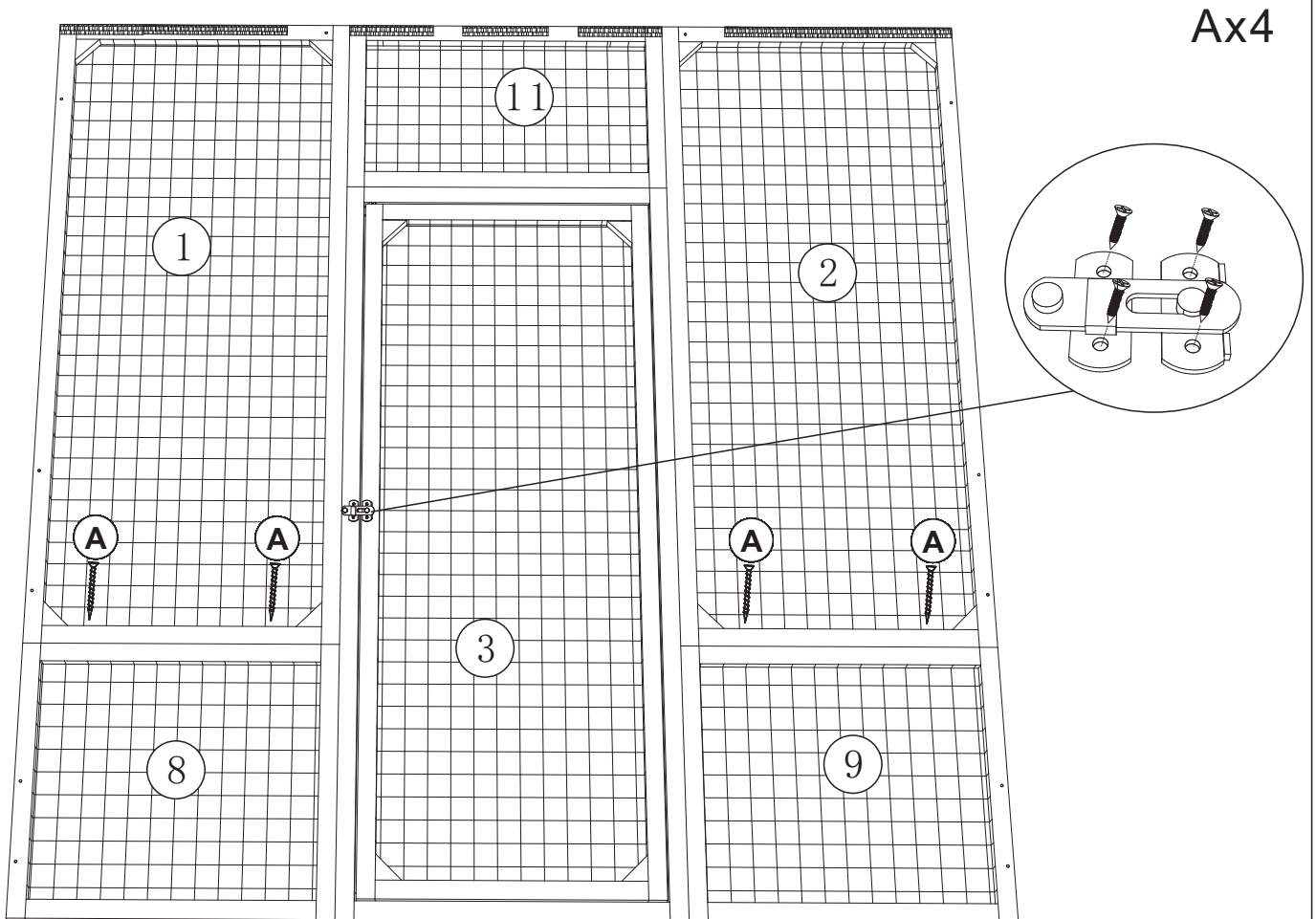

STEP 3

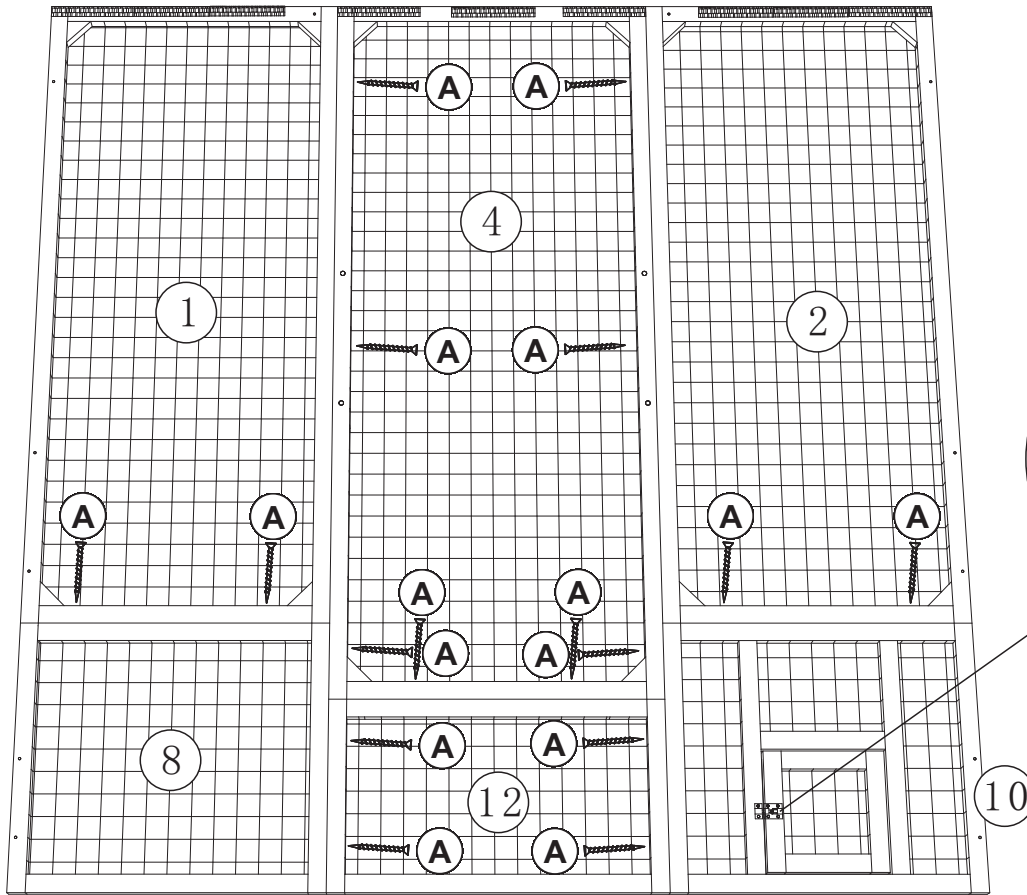

Ax16
Ex4

STEP 4

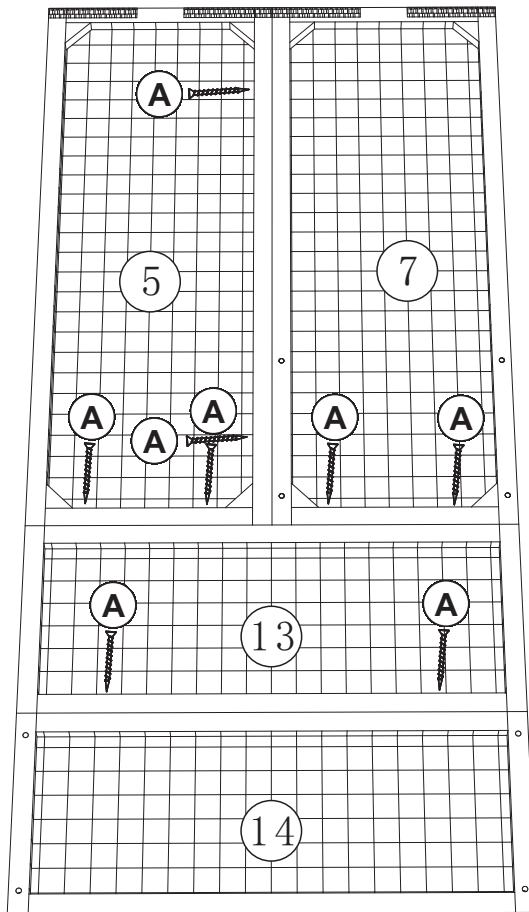

Ax8

STEP 5

Ax8
Ex4

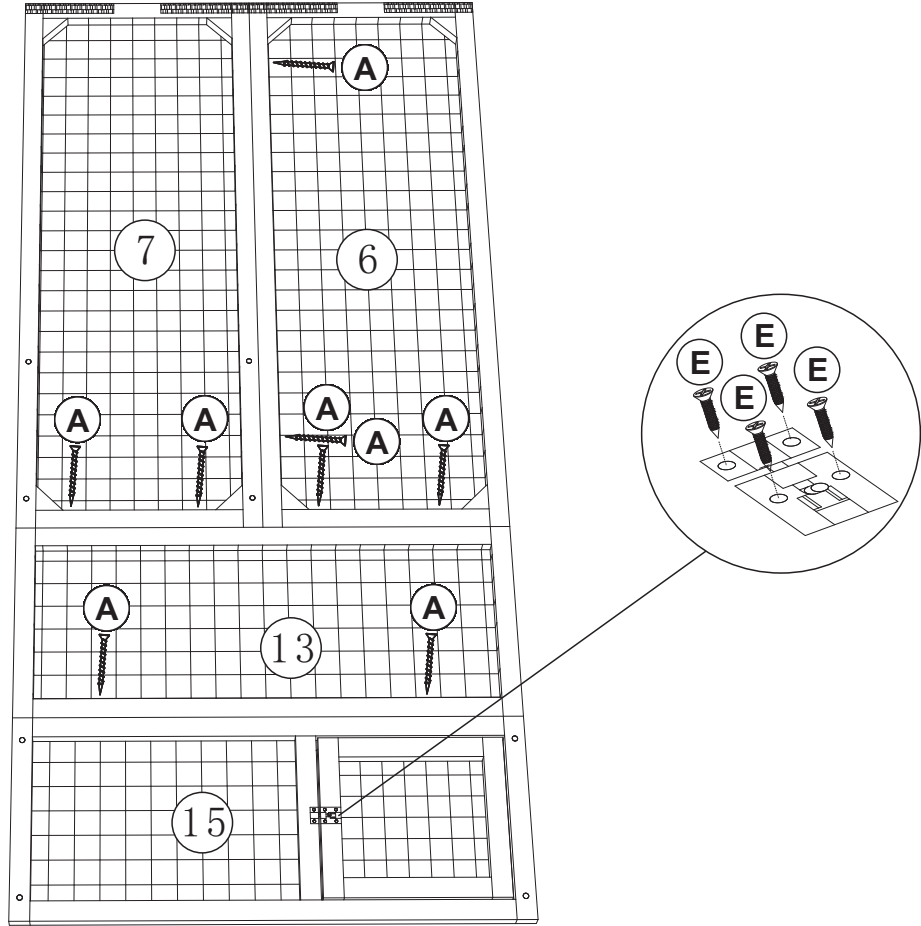

STEP 6

Bx5

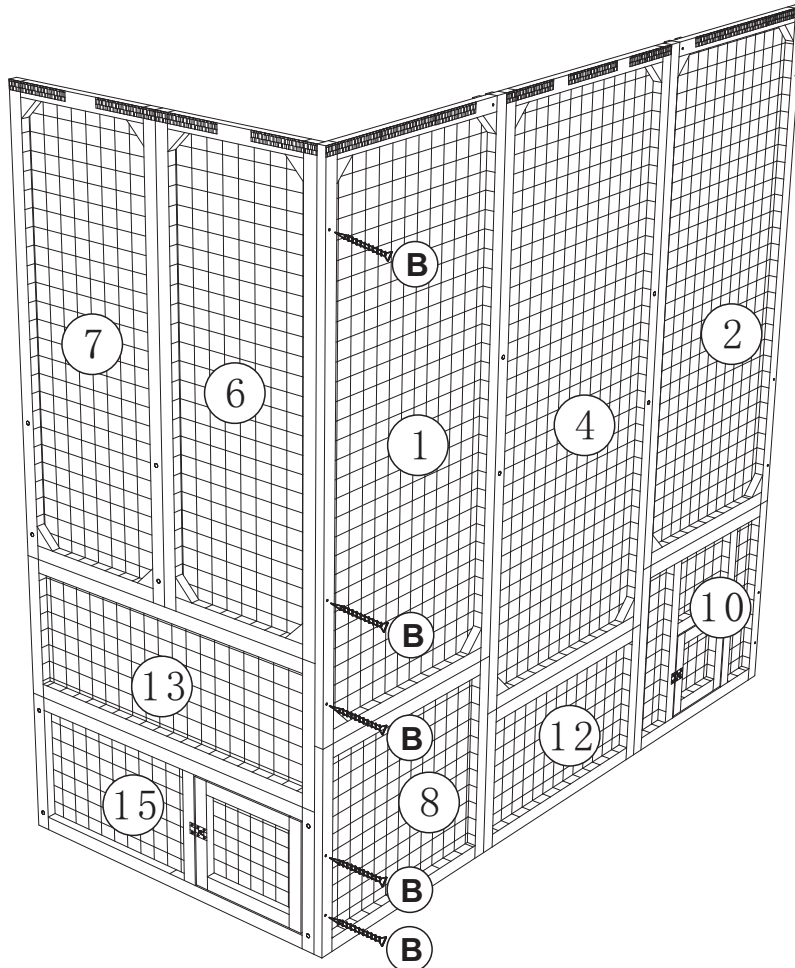

STEP 7

Bx5

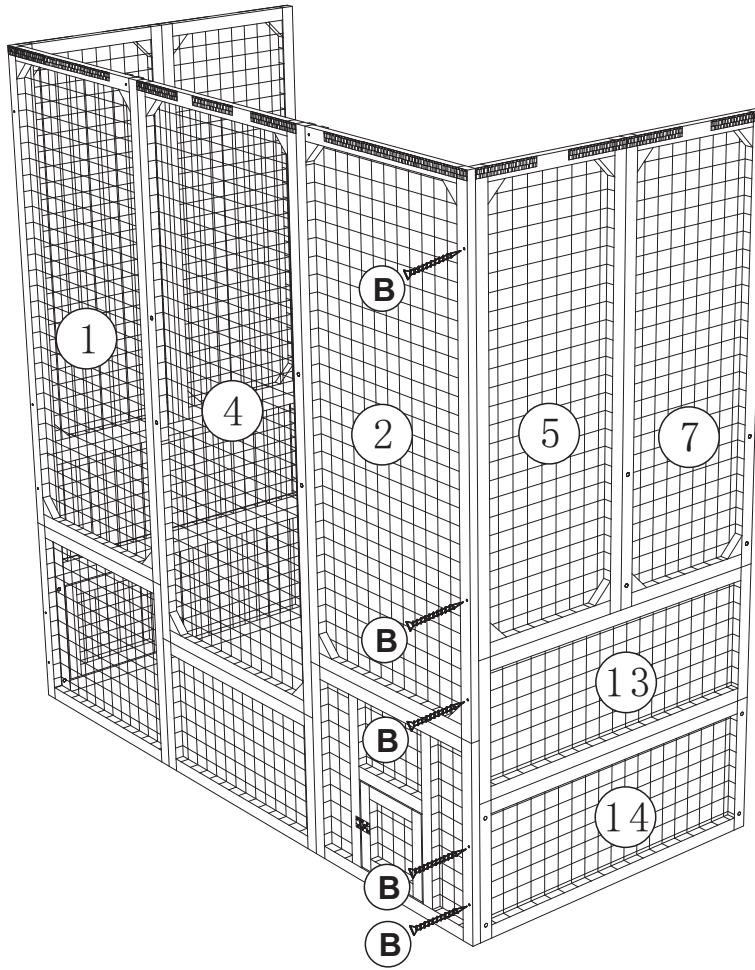

STEP 8

Fx20

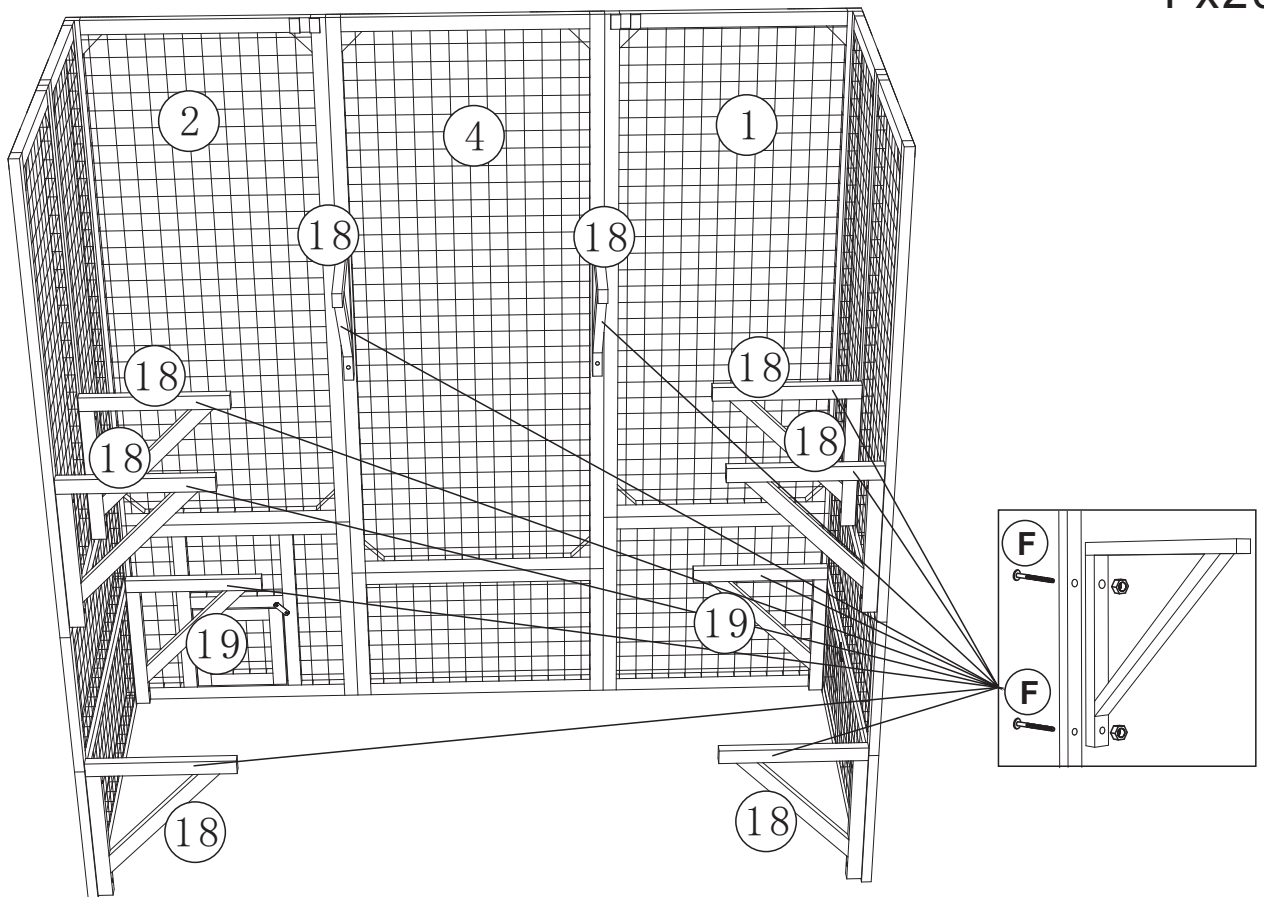

STEP 9

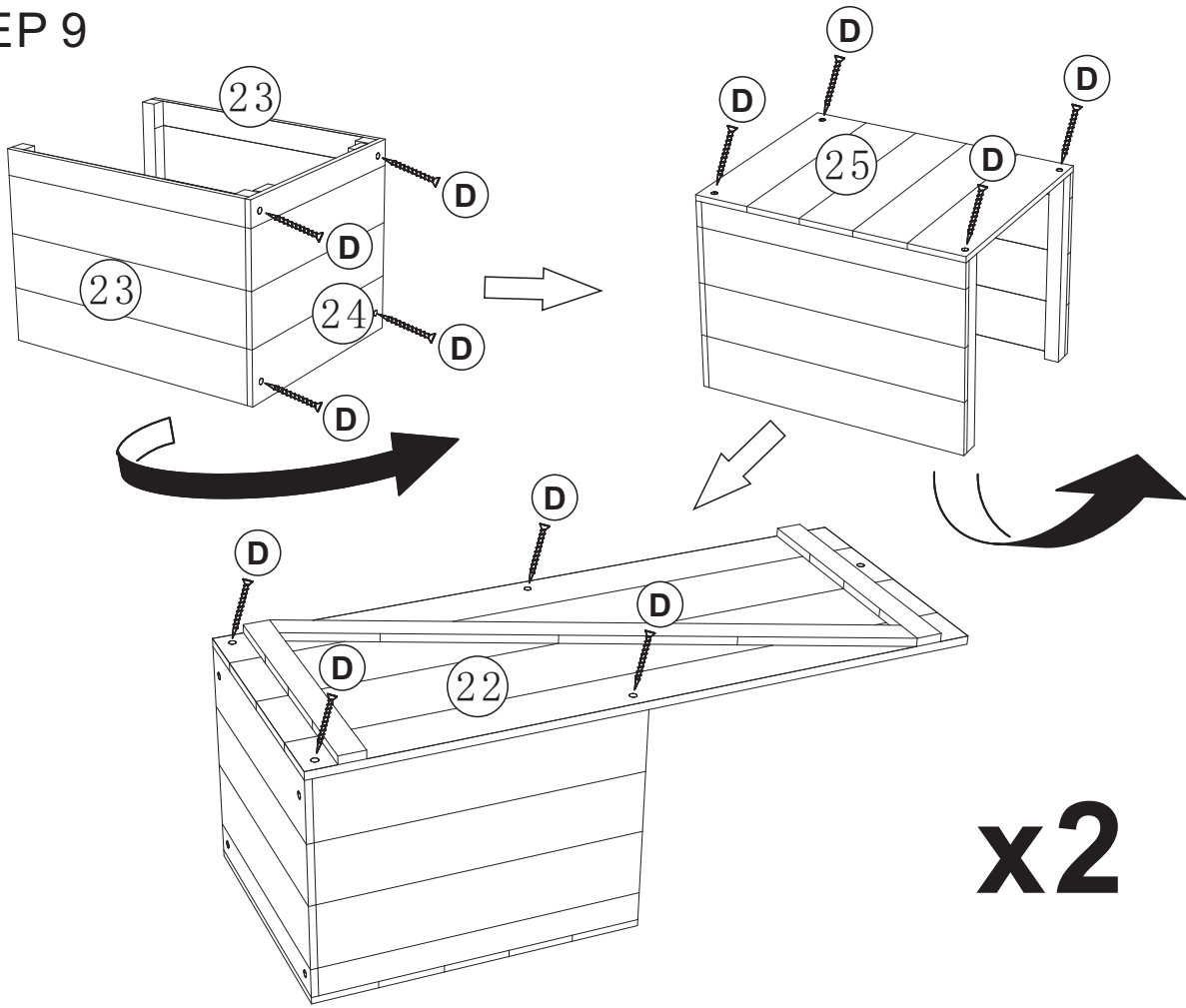

STEP 10

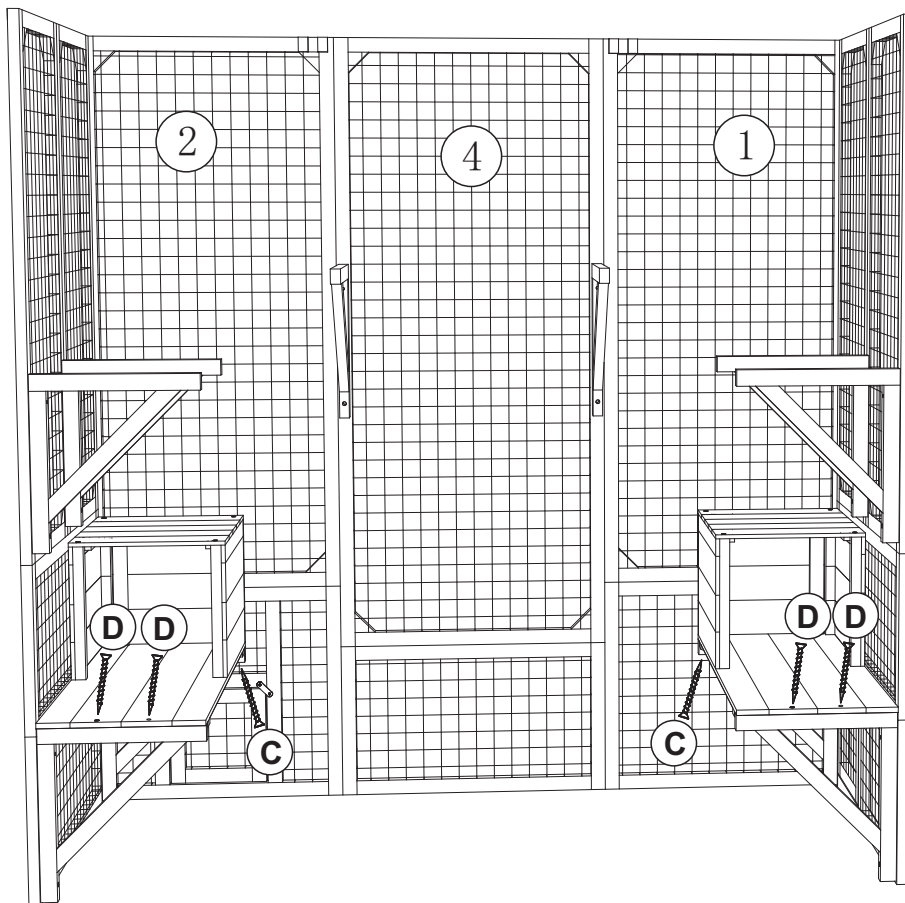

STEP 11

Dx12

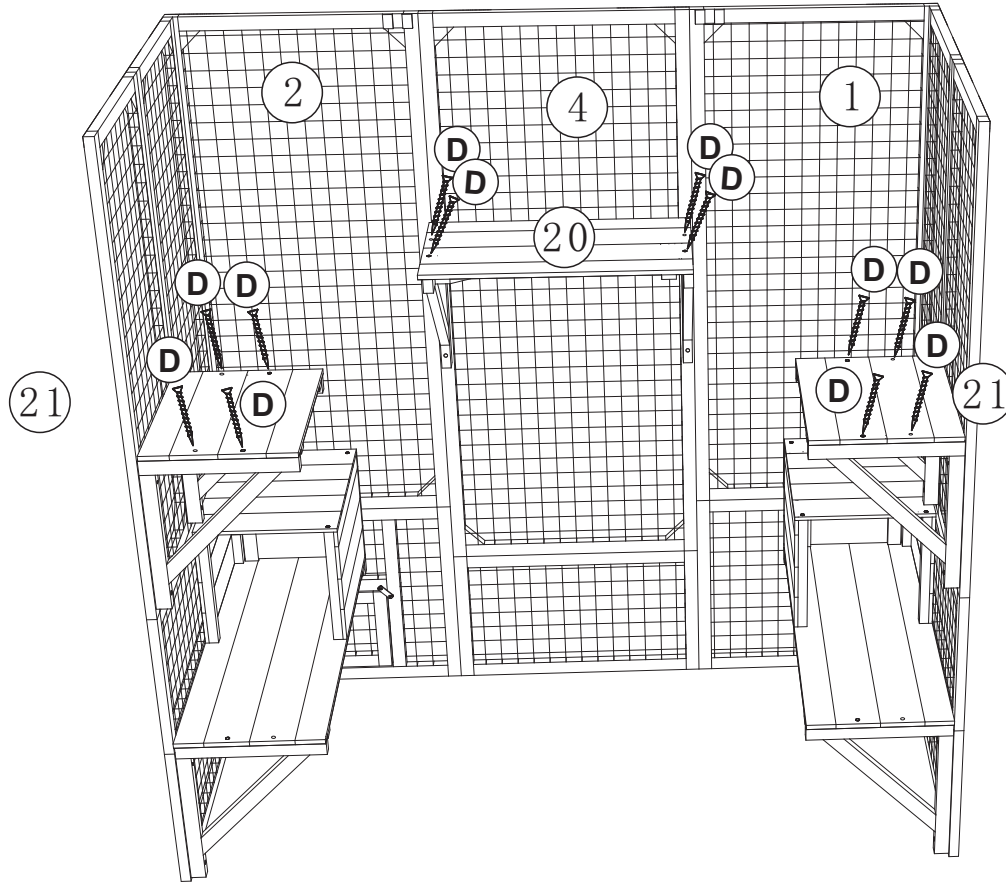

STEP 12

Bx10

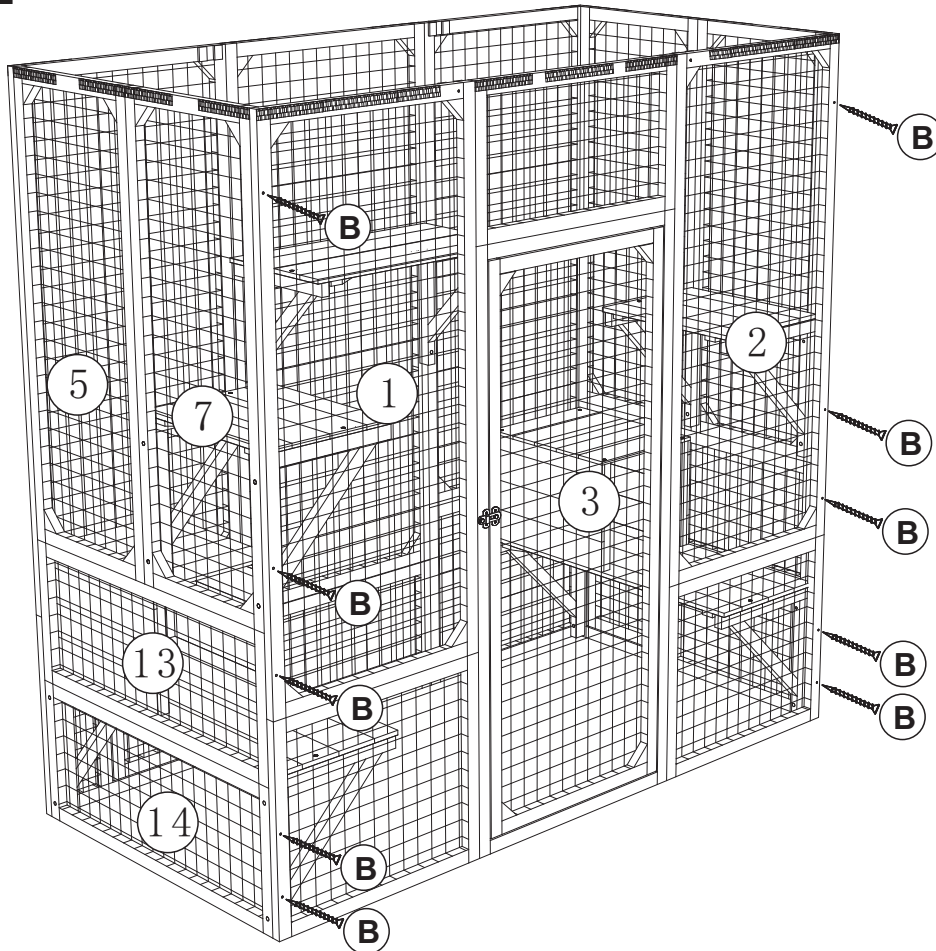

STEP 13

Ax8
Bx4

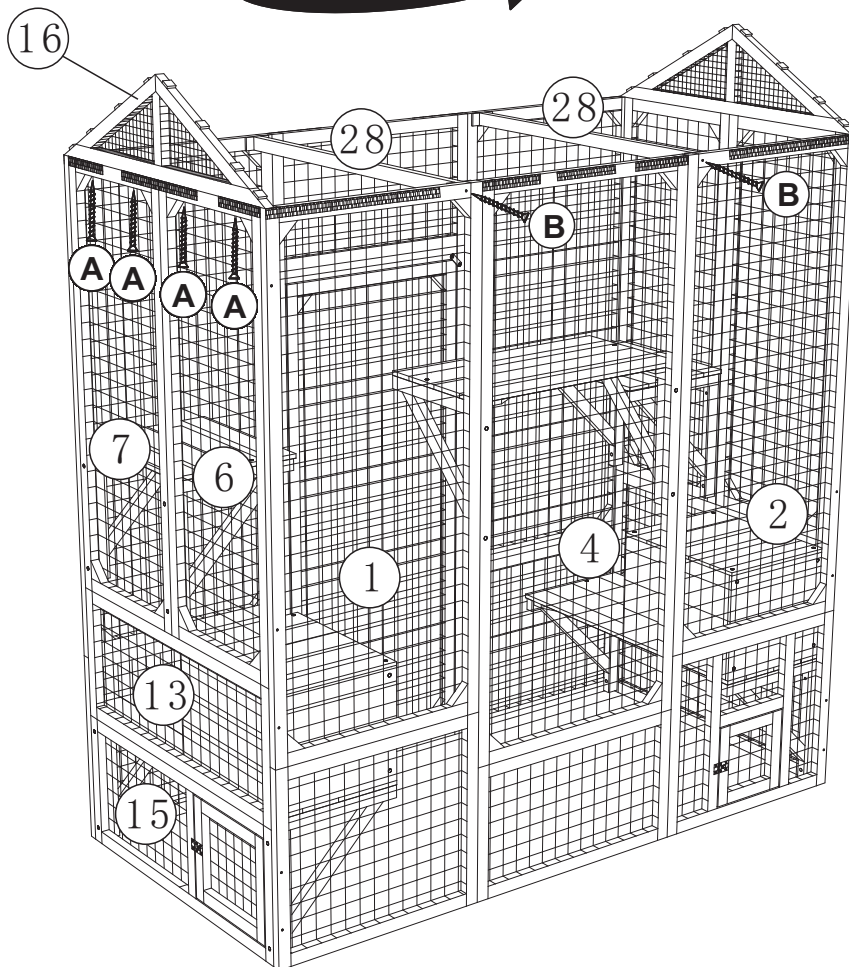
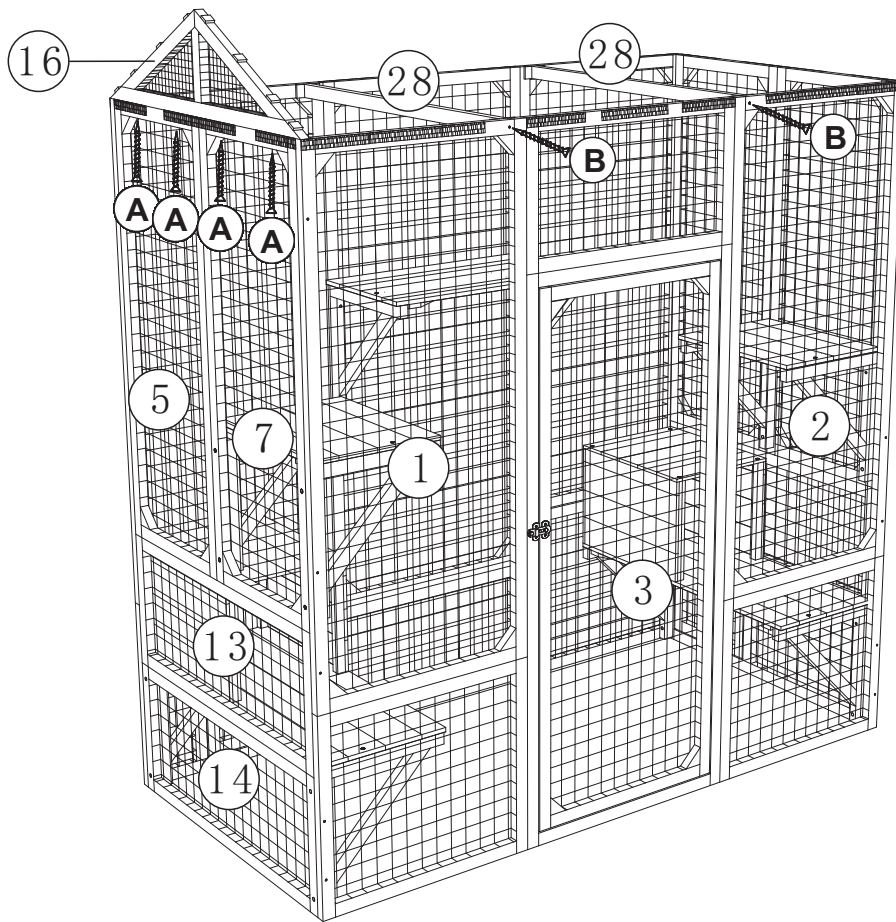

STEP 14

Ax4

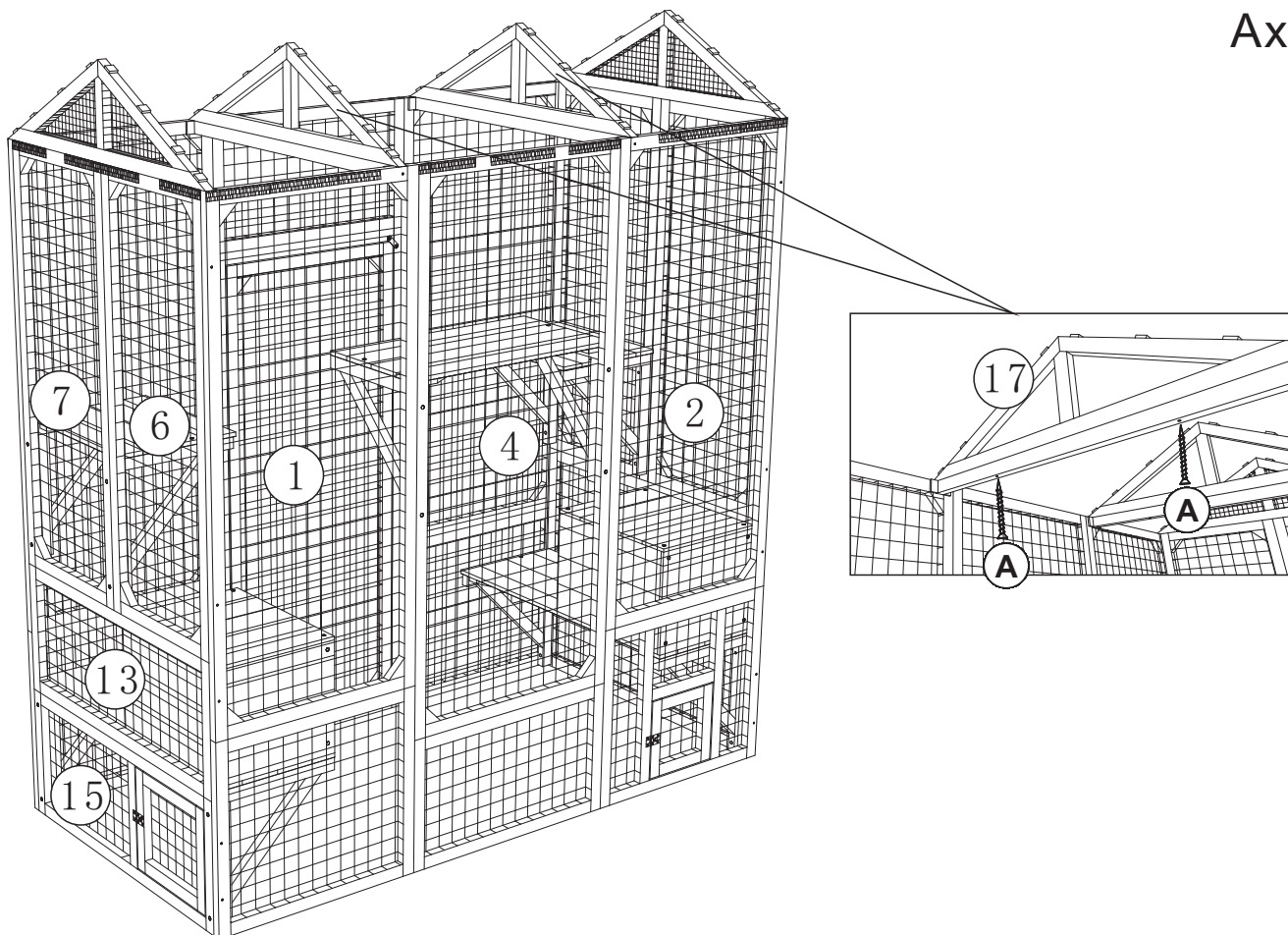

STEP 15

Ex16

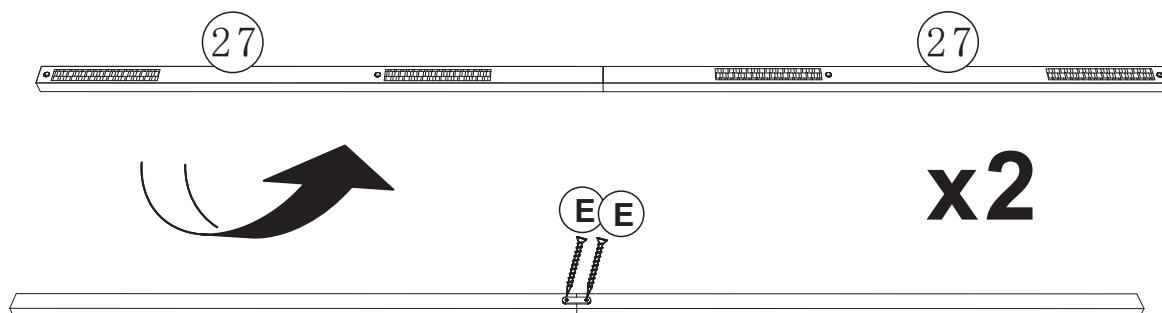
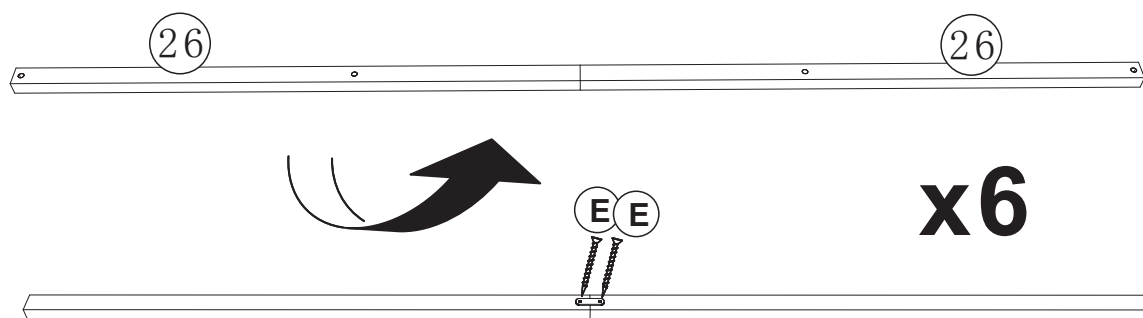

STEP 16

Bx24
Cx8

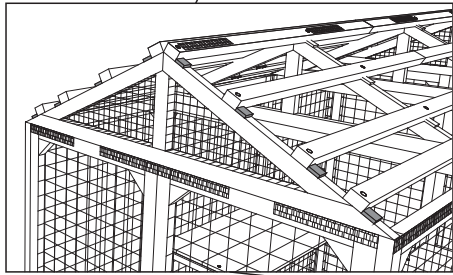
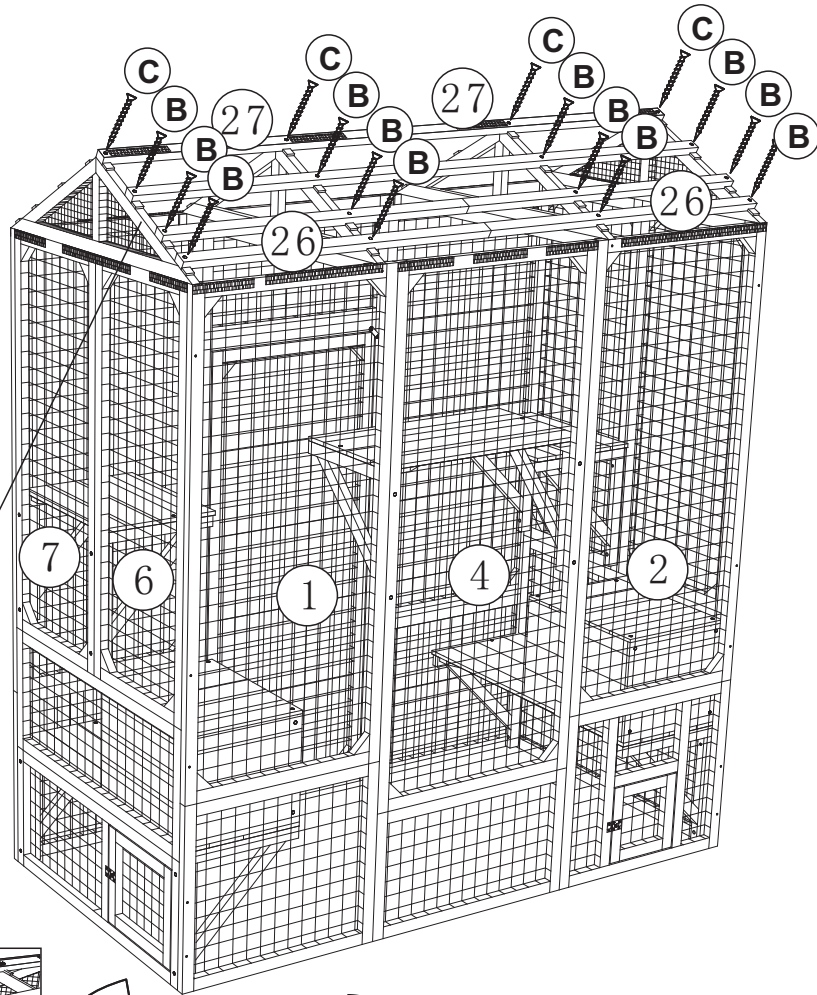

Note the position of
the part number 26

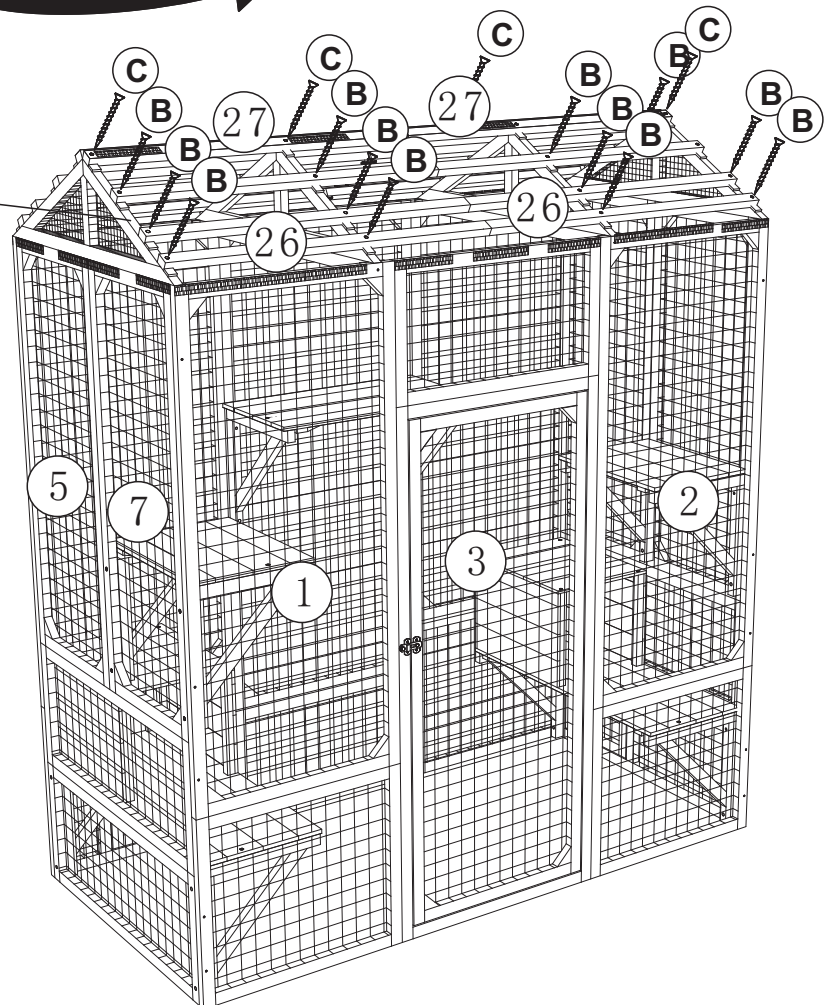

STEP 17

