

CARPORT USER MANUAL

10 X 20 FT

12 X 20 FT

⚠ Attention:

Please read the manual completely before starting the installation(A ladder & an electric drill are recommended for the assembly.)

1. Please confirm that the parts are complete and undamaged.

(Corresponding part number is affixed to each part)

If any parts are missing or damaged, please contact the customer support email to reissue or contact seller.





1.1 Please Contain: ① Order number ② Model number ③ Item Number ④ Photos of the missing/damaged parts(optional)





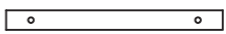
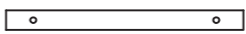
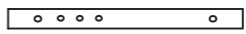

1.2 Steps to Contact seller (amazon.com orders only):





Step 1: Log into your Amazon account

Step 2: Go to “Your Orders” and find the purchase

Step 3: Click on “Contact Seller”

Item NO.	Item Name	Reference Image	Qty.
①	Steel Pipe		8 PCS
②	Steel Pipe		9 PCS
③	Steel Pipe		8 PCS
A	3-Way Corner Connector		6 PCS
B	4-Way Corner Connector		6 PCS
C	Foot Plate		8 PCS

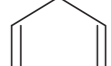
Item NO.	Item Name	Reference Image	Qty.
E	Ground Peg		32 PCS
F	M8 x 50MM Screw		8 PCS
G	Rope		4 PCS
H	Anchor		4 PCS
I	Bungee Cords		60PCS + 4 PCS Spares
			2 PCS

Item NO.	Item Name	Reference Image	Qty.
J	Top Cover		1 PC
K	Sidewall		1PC
K1	Sidewall		1PC
L	Zipper Door		2 PCS
			2 PCS

2. Arrange and classify the parts neatly to facilitate installation.

This is the part structure diagram of our product, you can combine this diagram and follow the steps to install

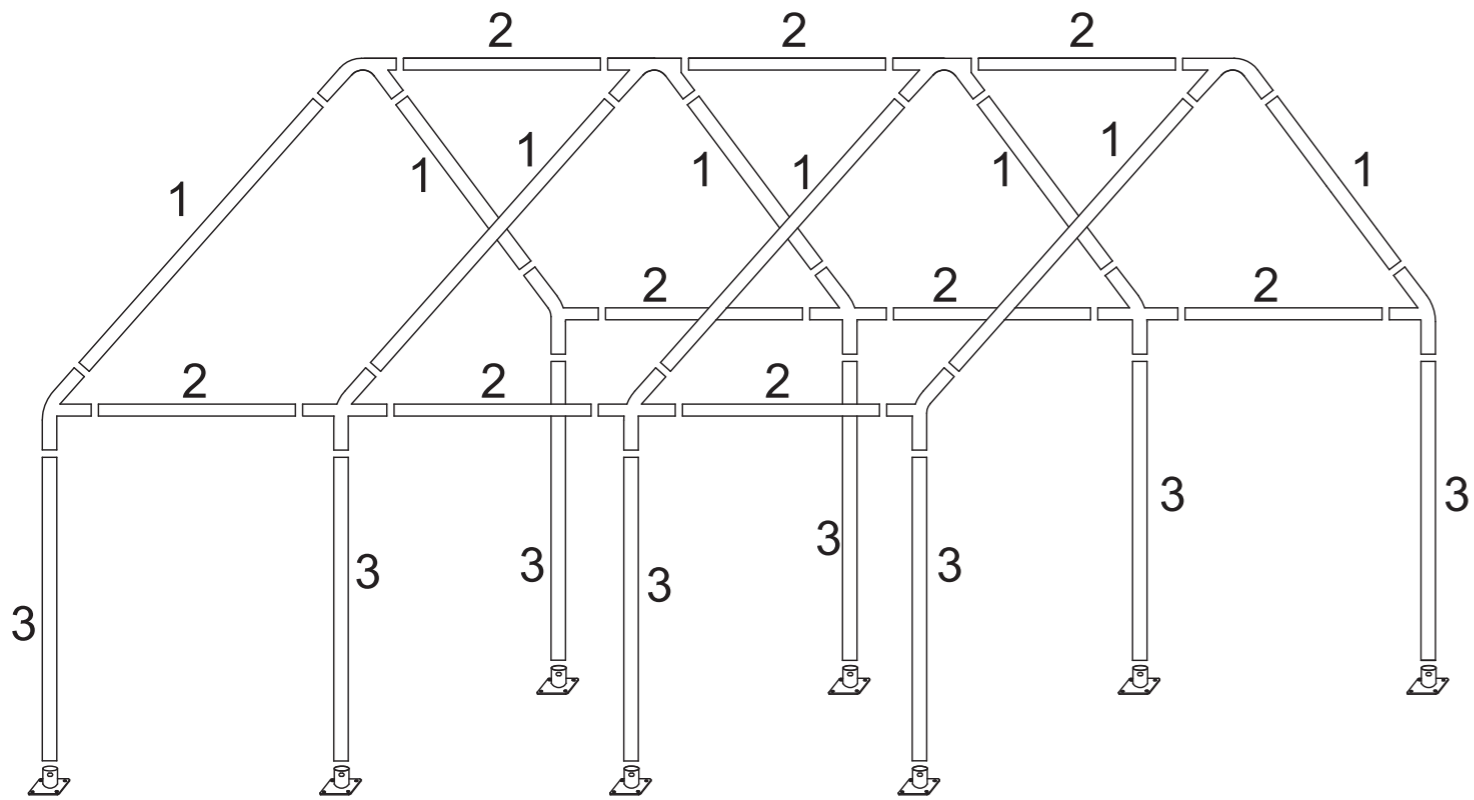

3. Start installation works

Step 1:

Assemble the long pipes required on the top of the carport (the length after connection is 20 feet), a total of three. You will use ② x 3 pcs
A x 2 pcs, B x 2 pcs for each pipe.

Part Required

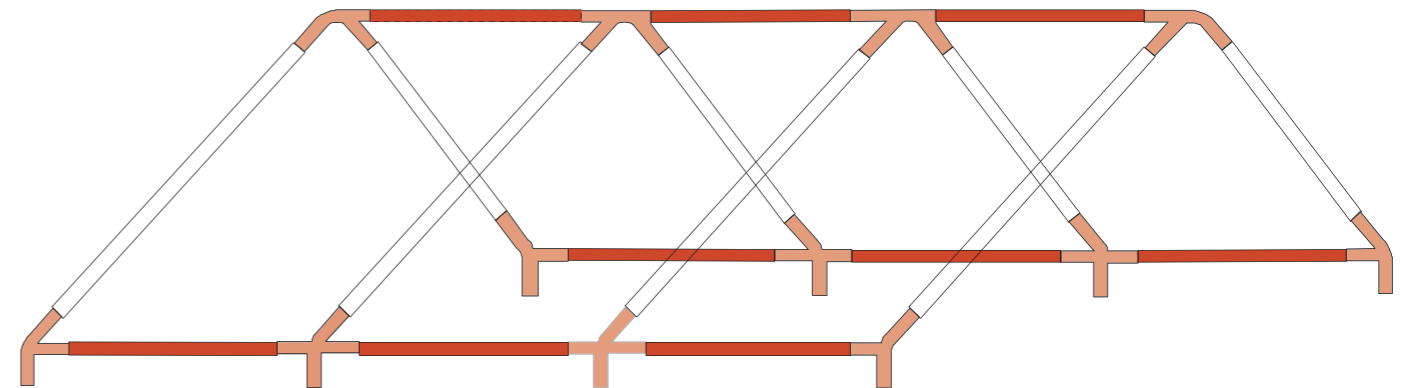
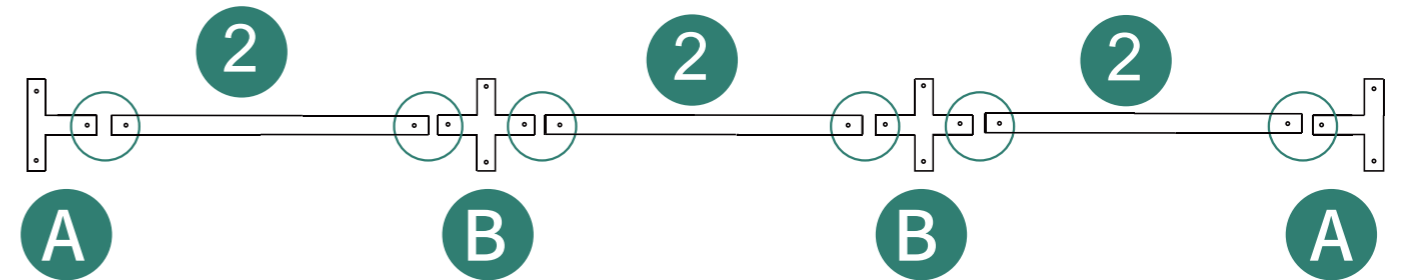

Step 2:

Connect the obtained three 20 Feet long pipes with the pipe ① to get the carport roof frame.

Part Required

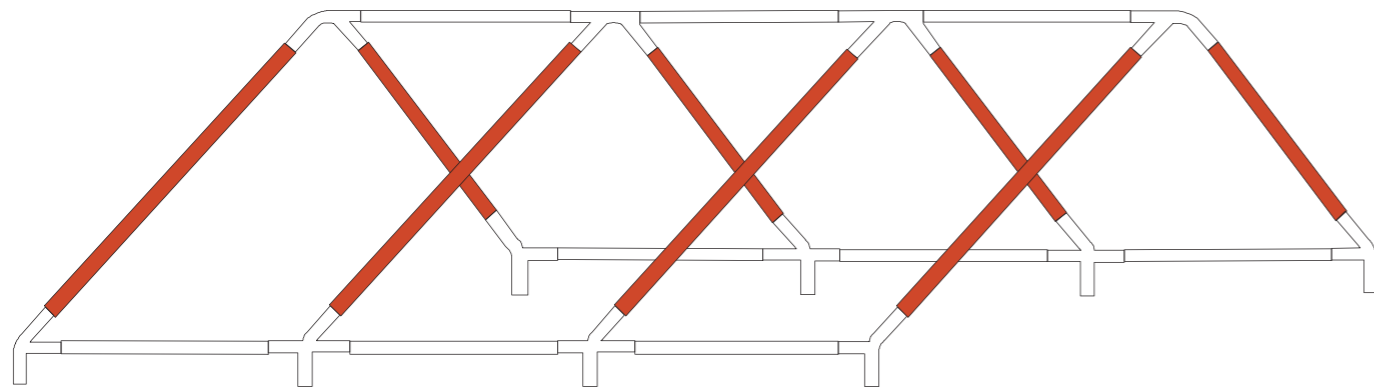
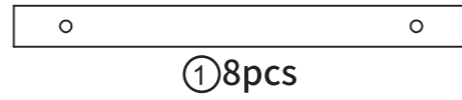

Step 3:

Put the Top Cover on the top frame

Part Required



J 1 PC

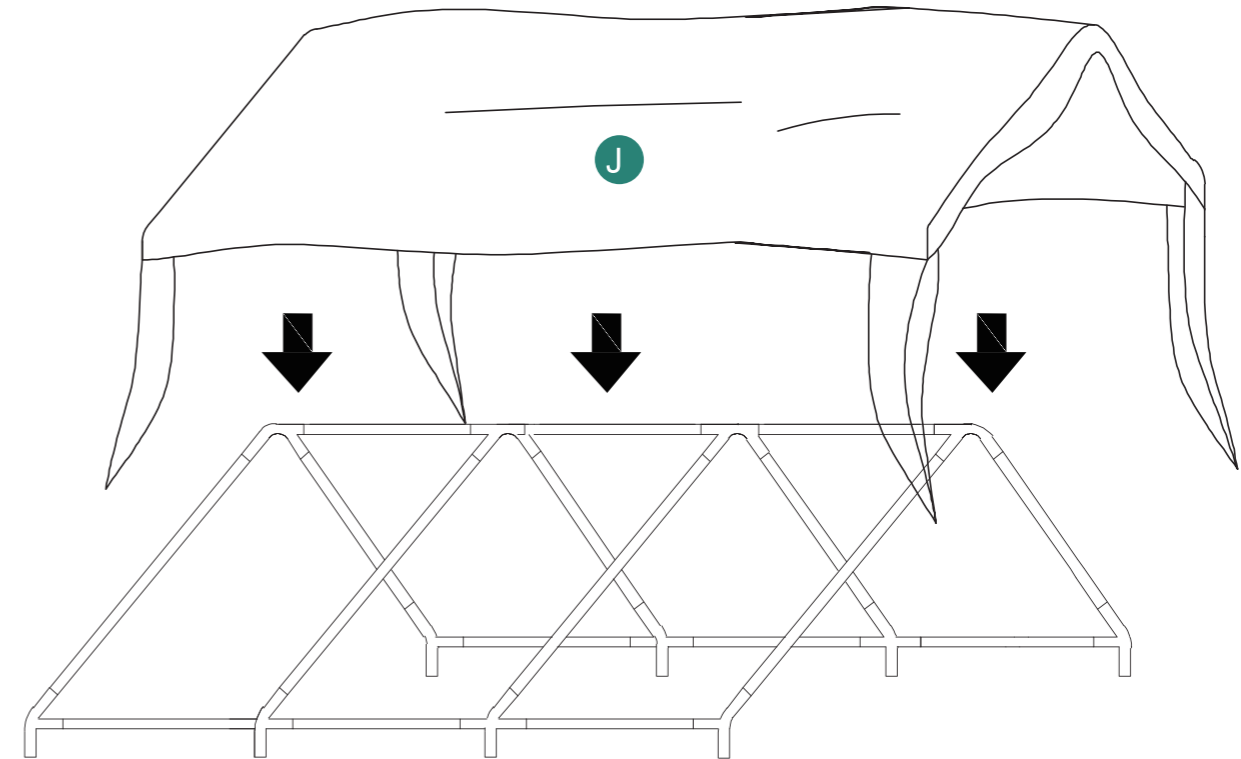

⚠ Attention: Be sure to cover the top cover at this time, otherwise the subsequent installation will not work normally

Step 4:

Connect 4 pipe ③ with the top frame.

Part Required

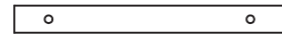

③ 4pcs

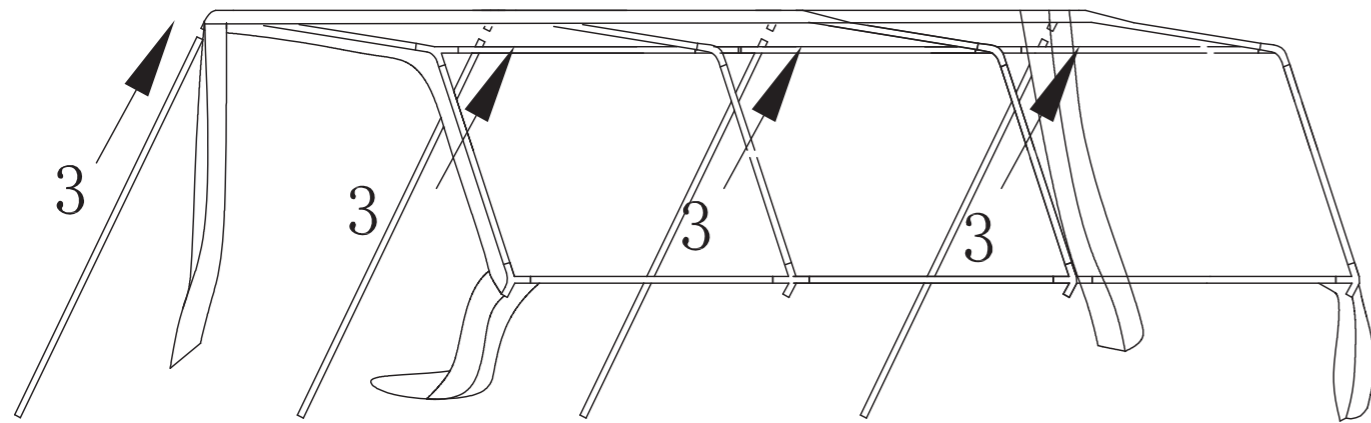

Step 5:

Part Required



I 12 PCS

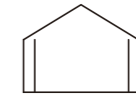

L 2pcs

Pass 2 doors through bungee jumping rope

Installed in the frame

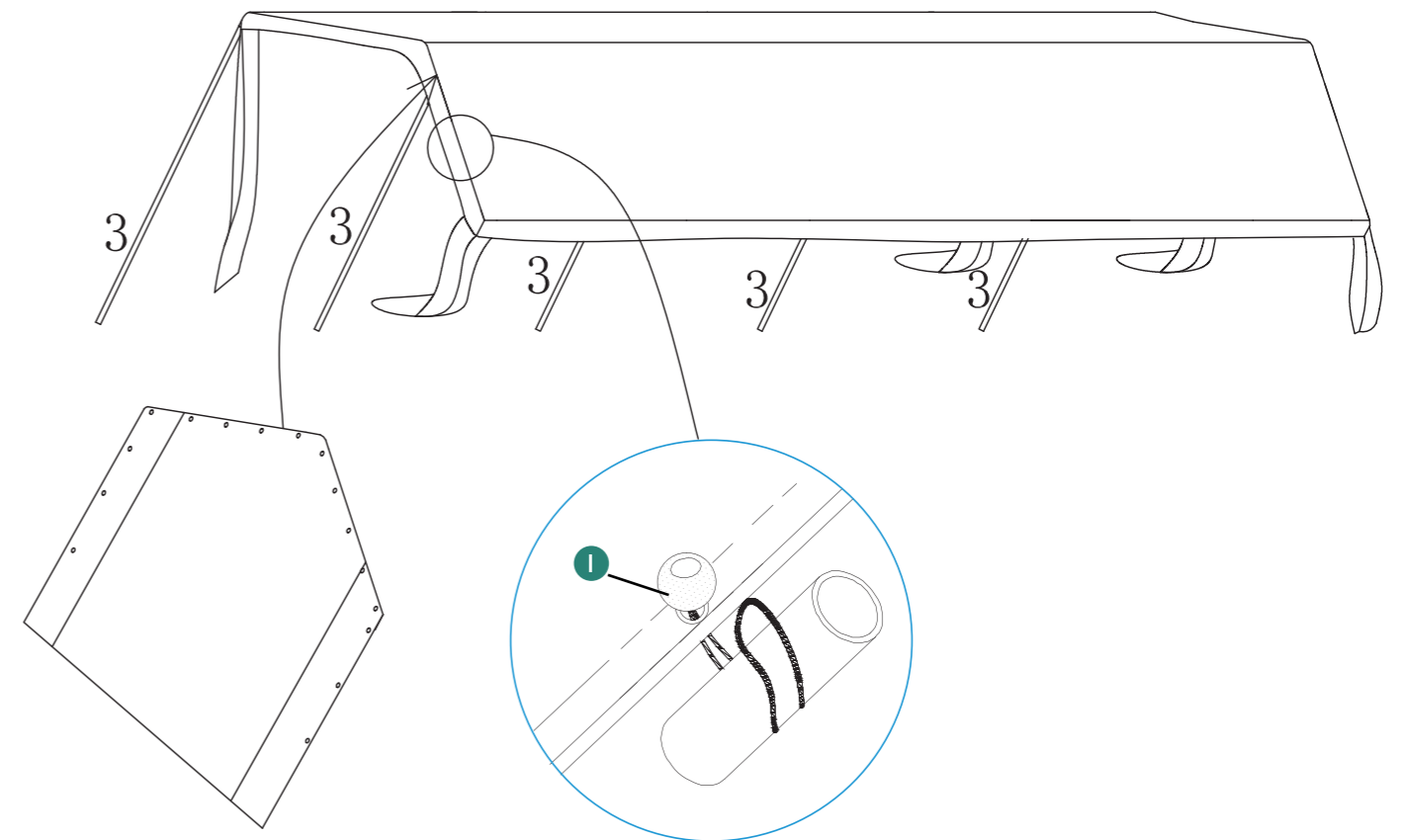

Step 6:

Repeat the Step 4 to install another side.

Part Required

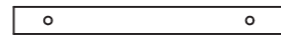

③4pcs

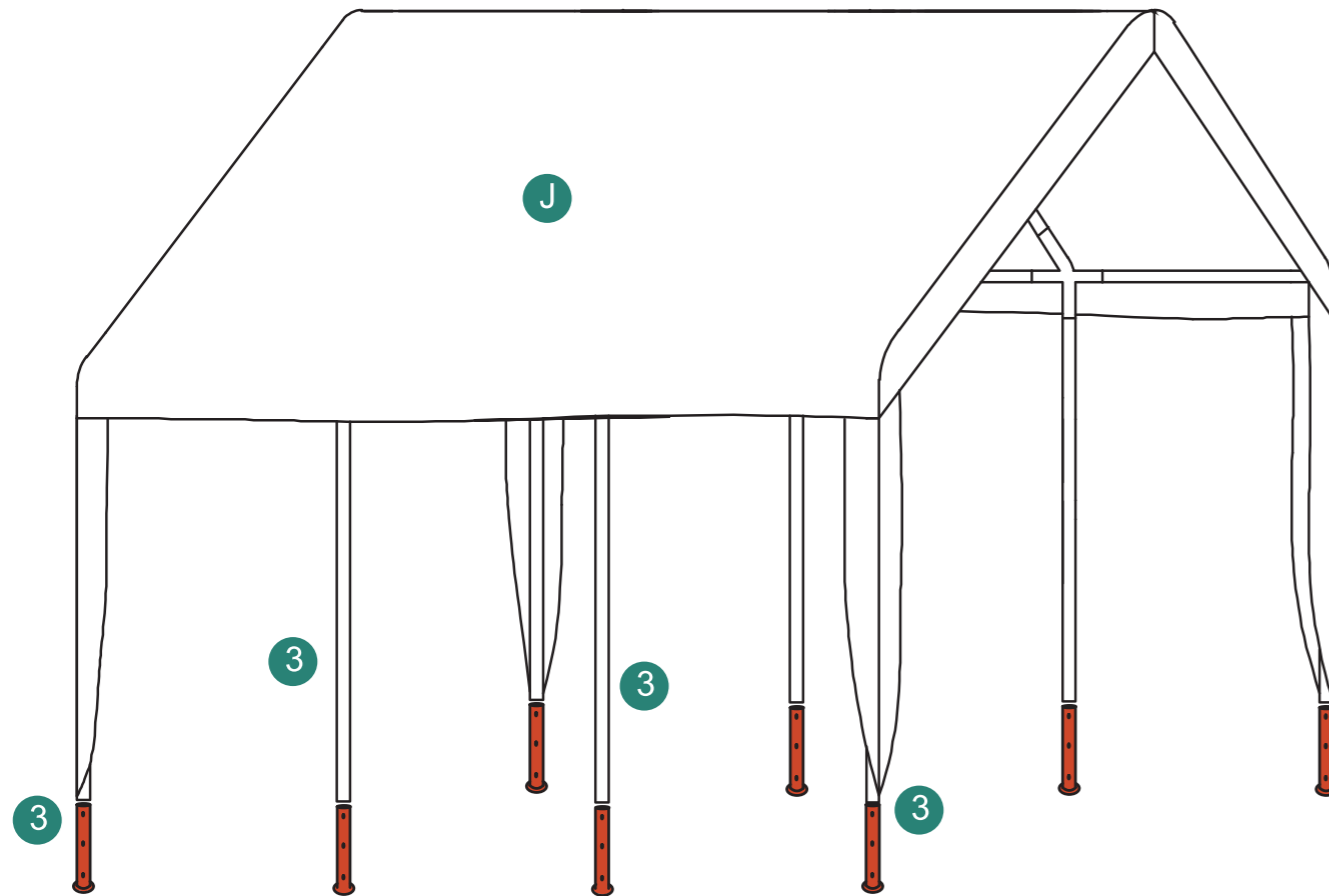

Step 7:

Connect the pipe C with ③ pipe that already installed, at this point you will get a complete carport frame with roof.

Part Required

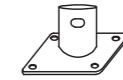

C 8pcs



F 8pcs

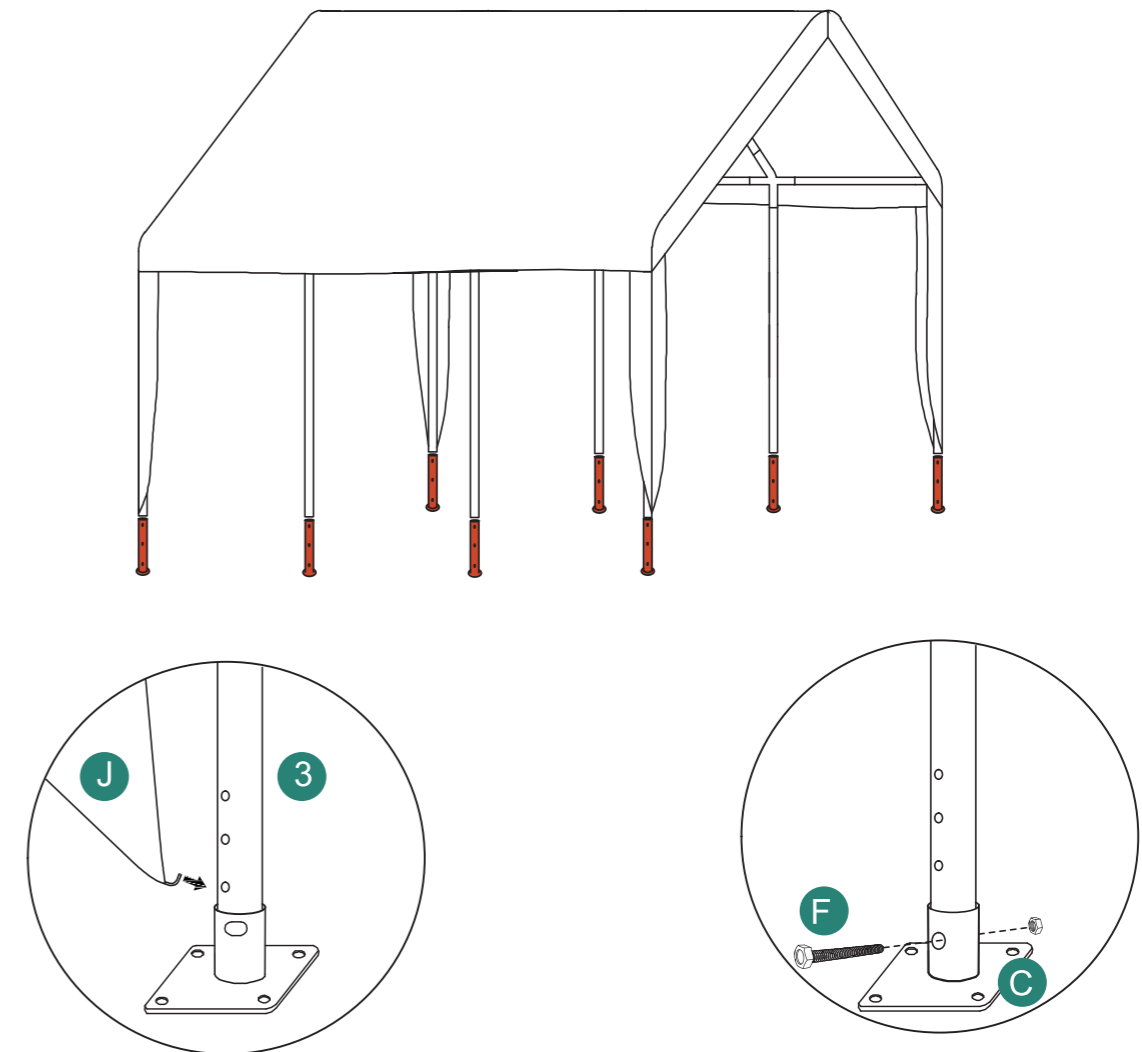

Step 8:

Use bungee cords to install the gate and side walls.

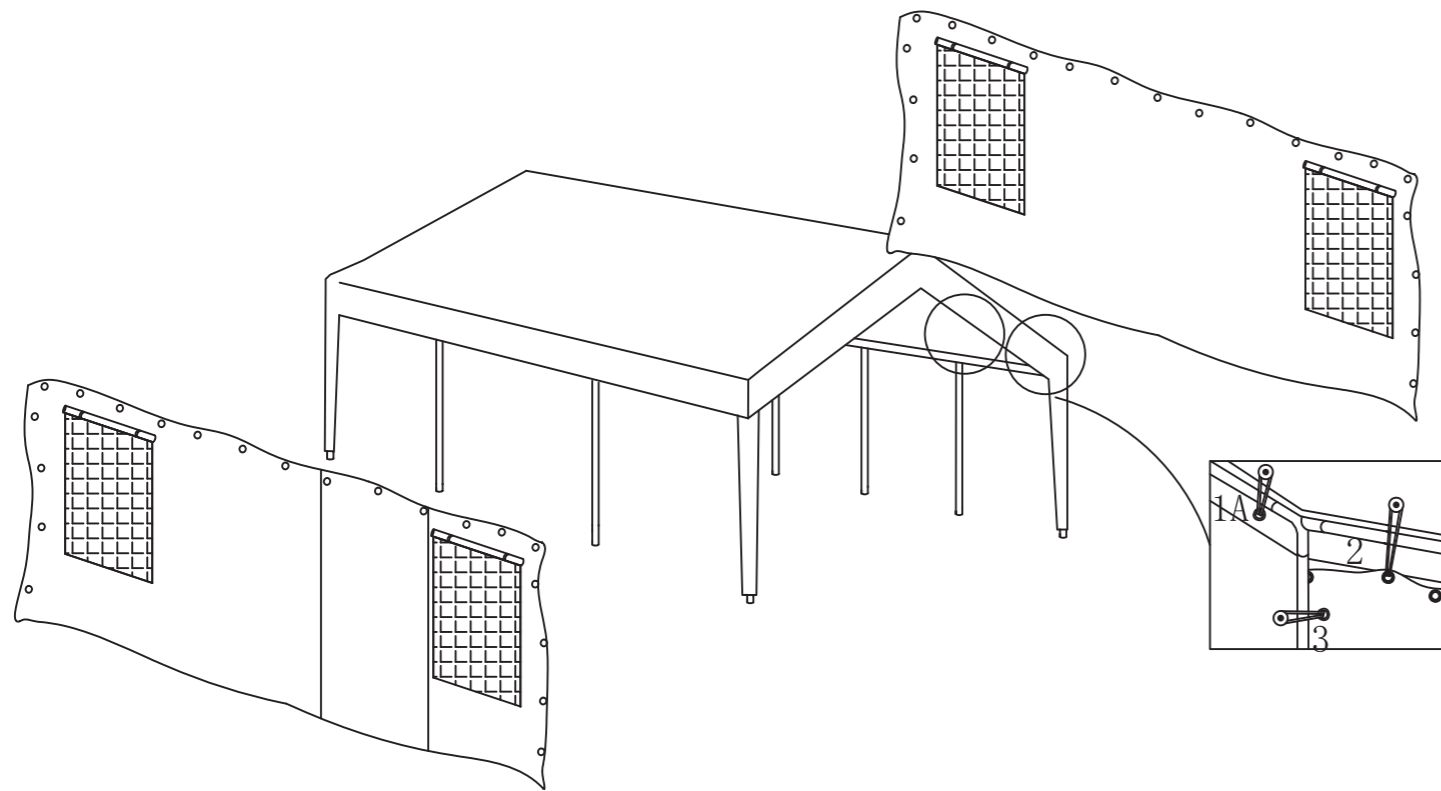
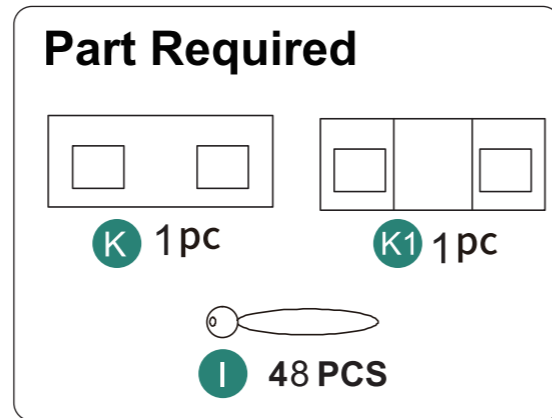

Step 9 :

Fix the drawstring and tent feet to the ground.

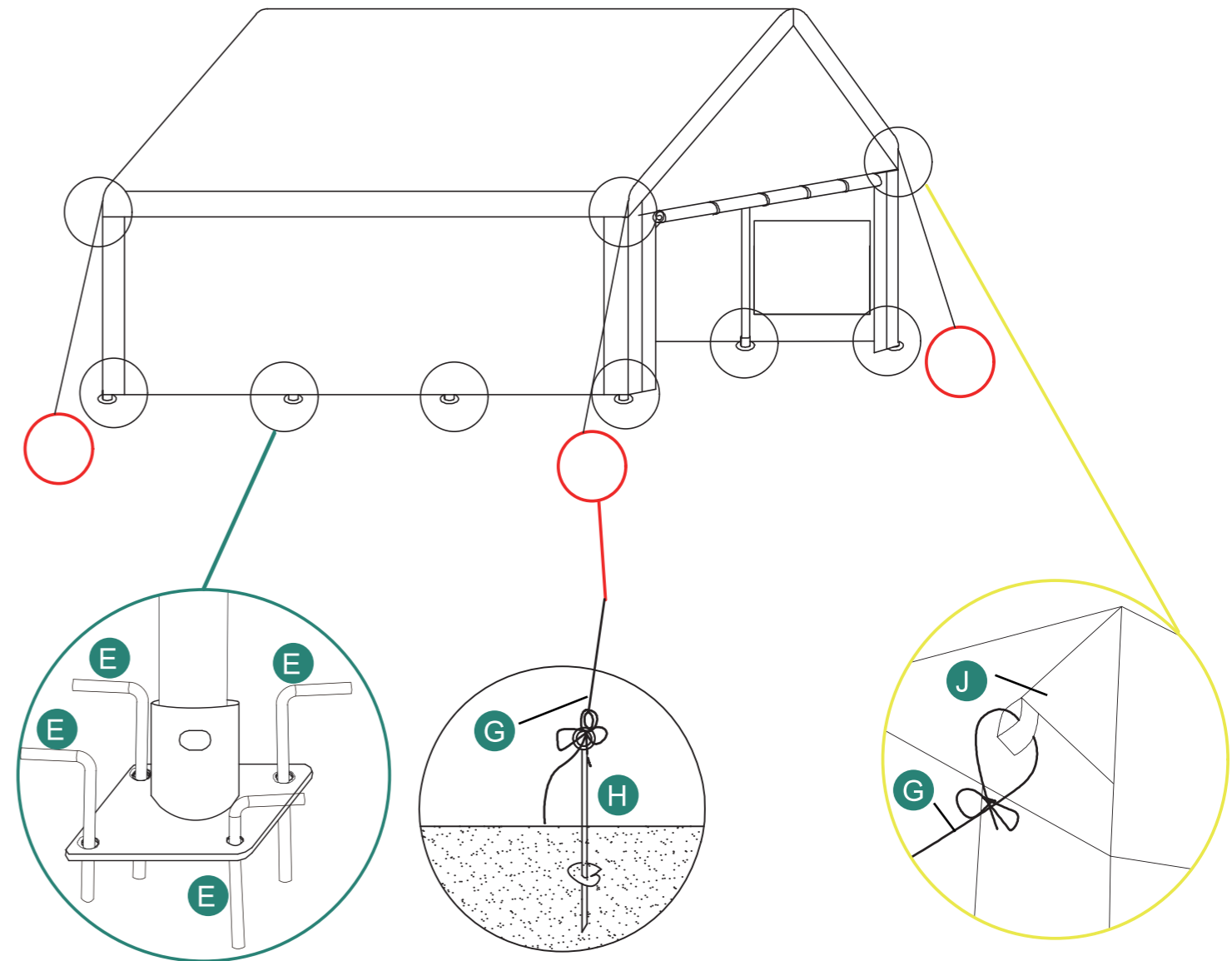
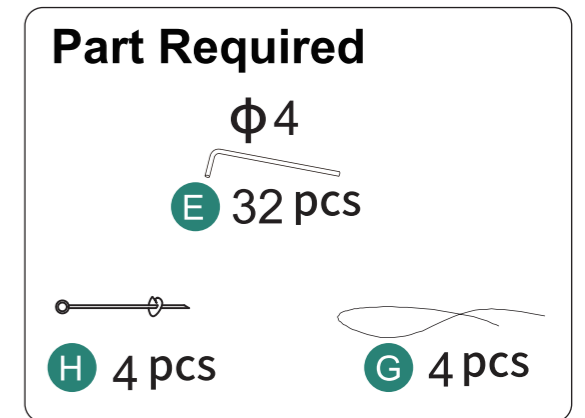

Step 10:

