

Patio Chaise Lounge Chair Assembly Manual

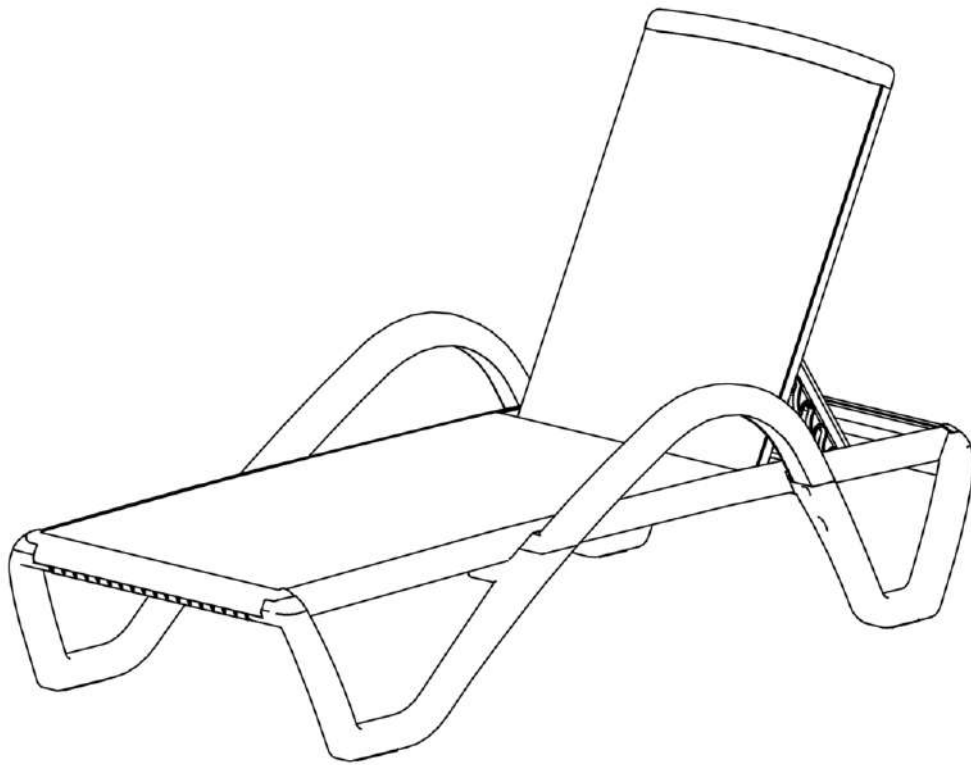

- Prior to assembly, please confirm all of the parts listed included.
- All bolts should be tightened before use. Maybe, you need allen wrench for assembly.

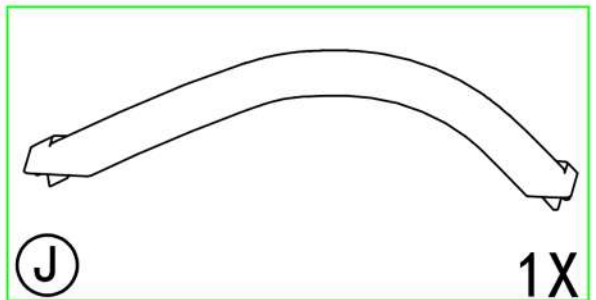
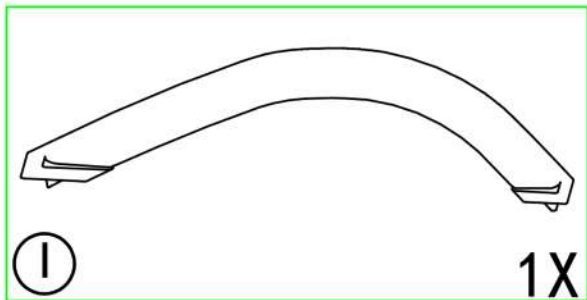
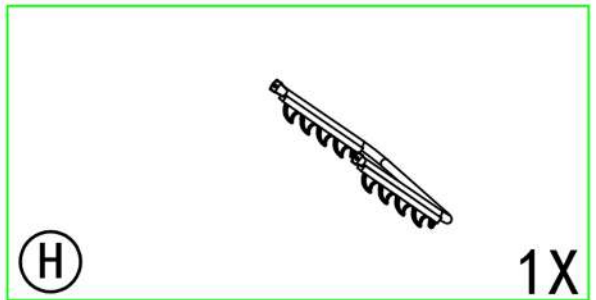
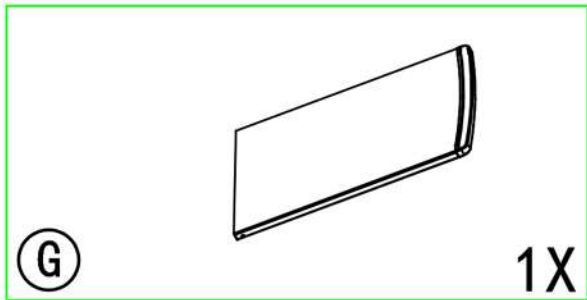
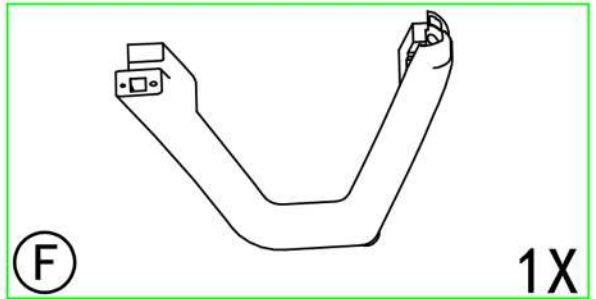
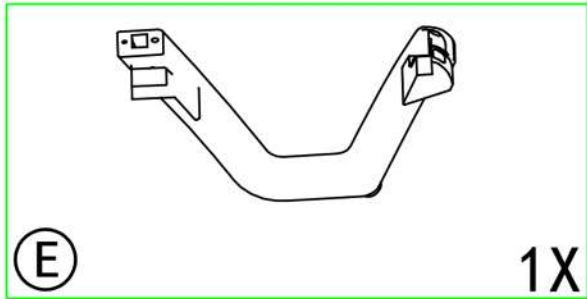
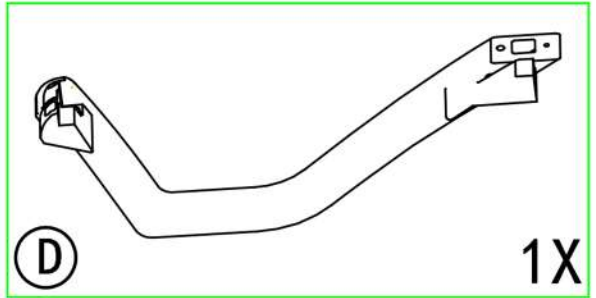
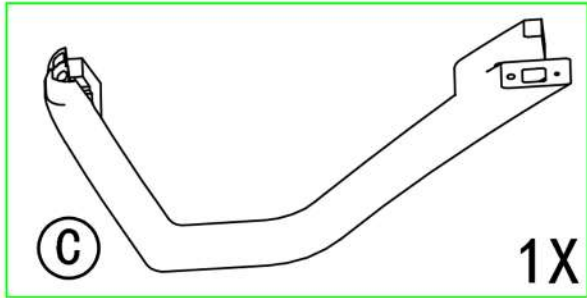
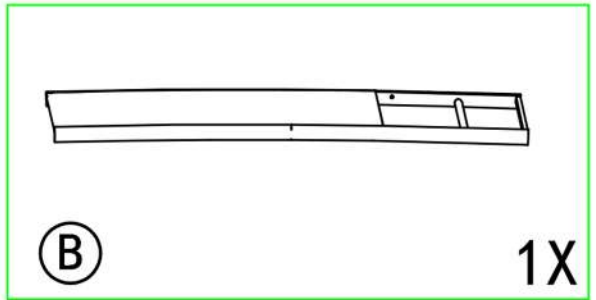
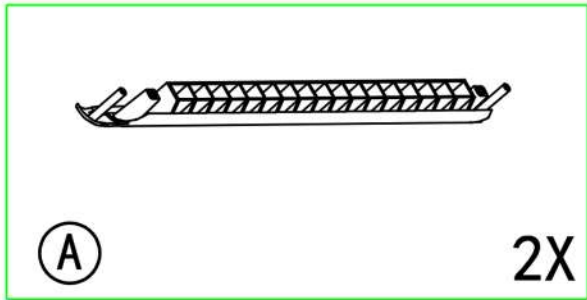

Please assemble the lounge chair on the carton or carpet to avoid scratch.

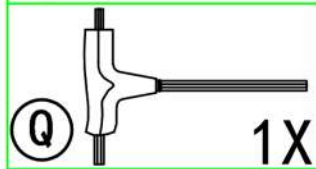
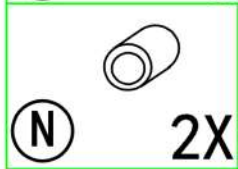
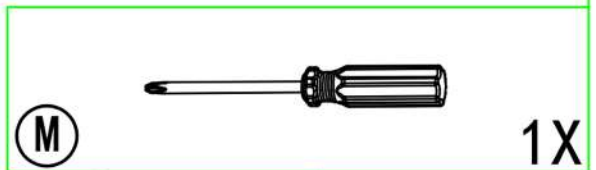
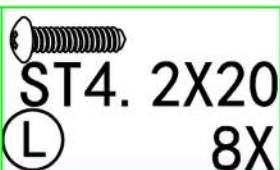
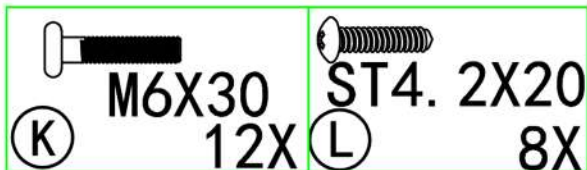
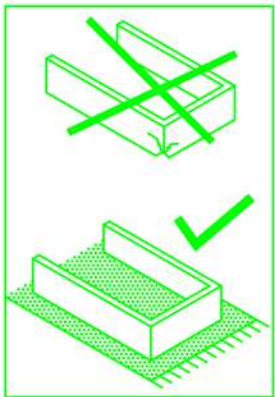

1

Warm Tip: Please don't tighten screws before finish assemble.

Assemble four legs Part C,Part D,Part F and Part E to the seat Part B with screws Part K.

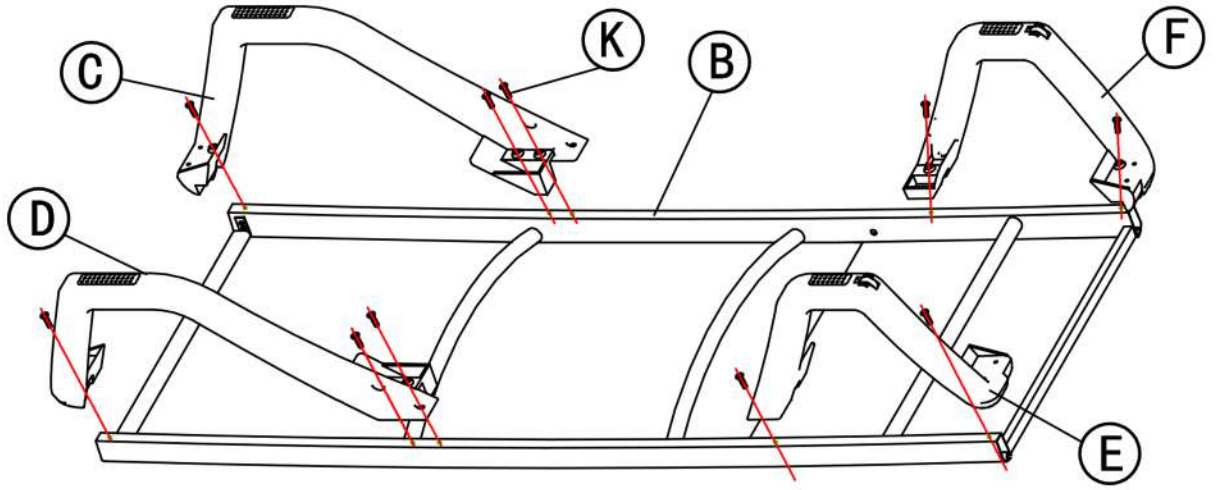

Assemble Part A to the seat Part B,then assemble Armrest Part I and Part J to the seat Part B.

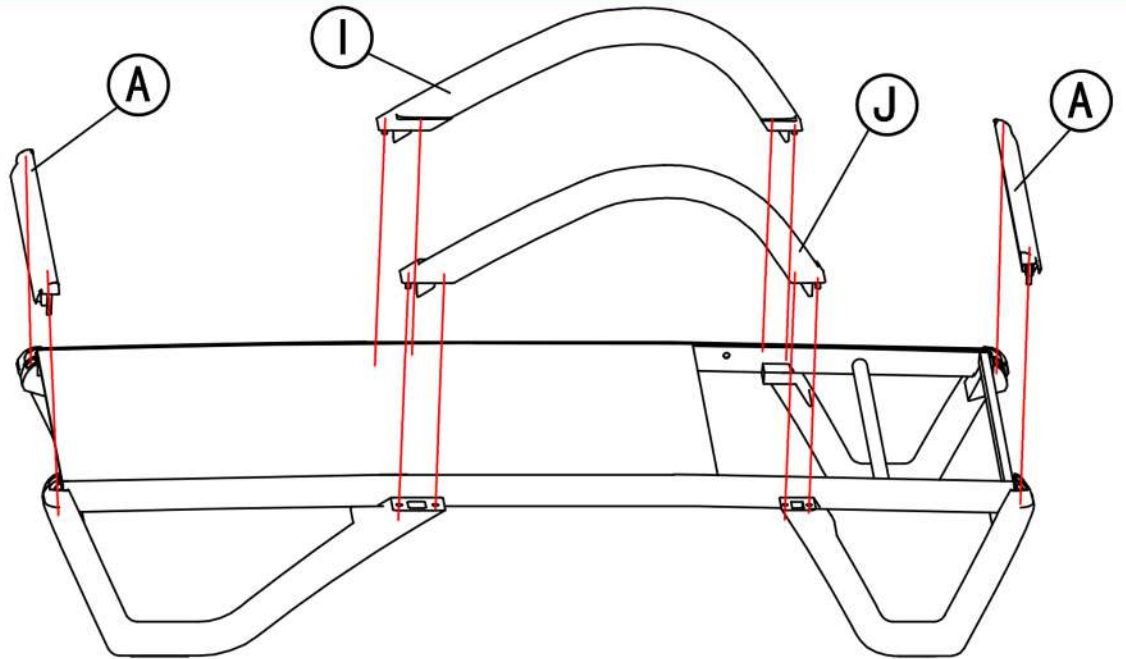

Then use screws Part L and Part P to lock the legs. Tighten all screws before using.

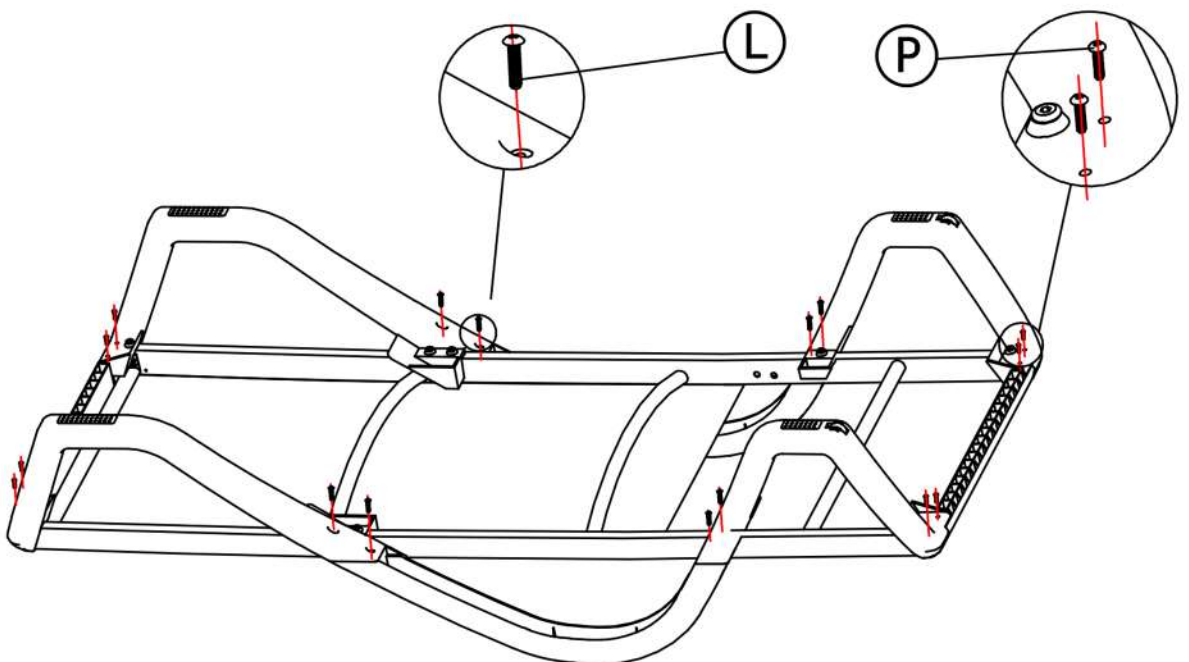

Assemble backrest Part G and adjustable gear Part H together using screws Part K and Part N.

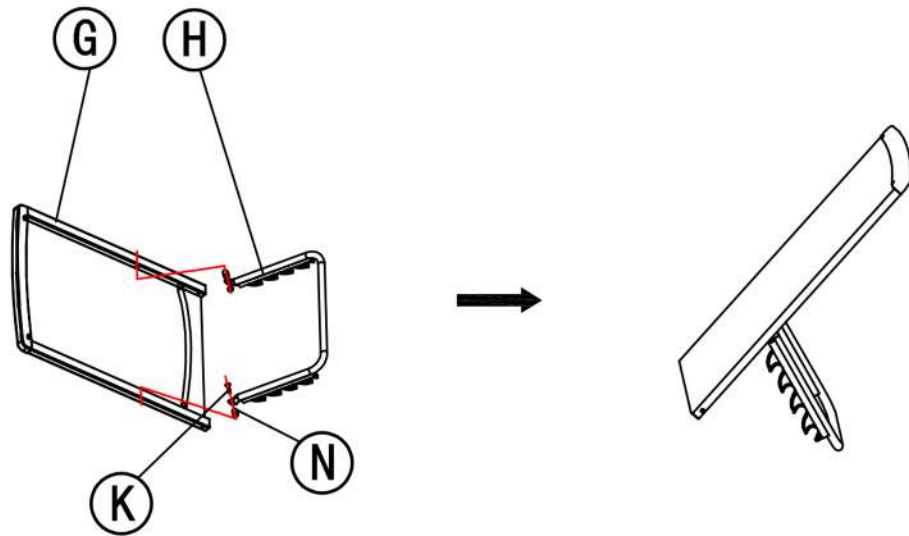

Assemble backrest and adjustable gear to the seat Part B with screws Part R.

