

# LOVESEAT

## ASSEMBLY INSTRUCTIONS

MODEL NO.: 9157E

---

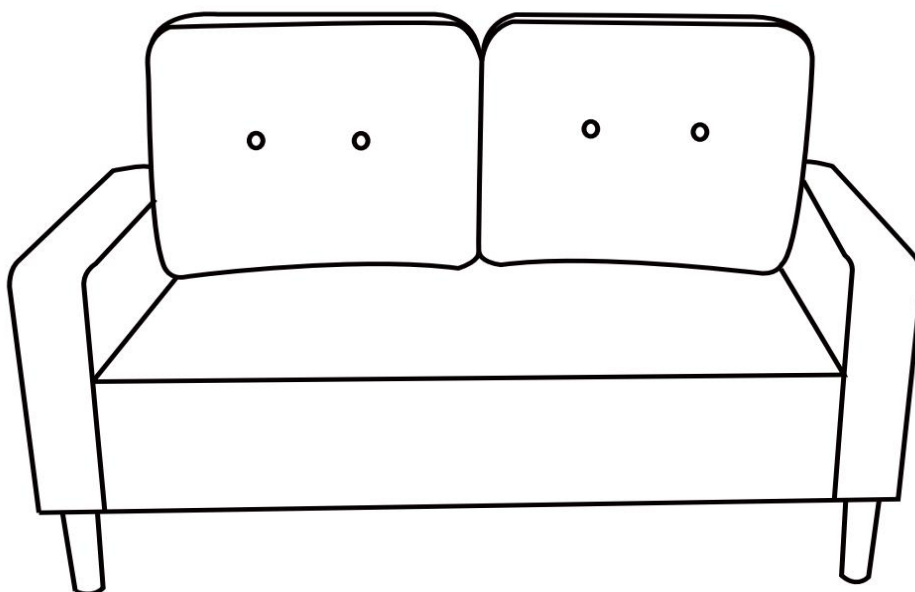

*(Vacuum Packing)*

---

### INSTALLATION VIDEO

Please scan QR code with iOS or Android phone camera ,  
click the link to play the installation video.

If QR code is damaged, please contact us to get installation video.

If no access for cell phone scanner, please try other APP.

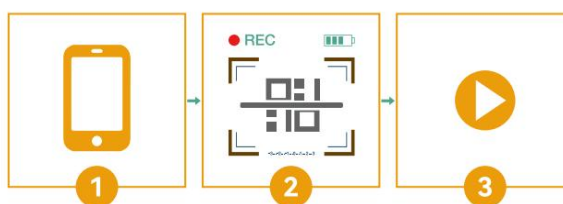

Thanks for your purchasing.

- Please read the instruction completely before assembly.
- Please do not throw away any of the packaging or the instruction until you have all the components and when the furniture is fully assembled.
- Considering the size and weight of the sofa, we recommend two adults to assemble the sofa, on a carpeted or padded area.
- Keep all components and packaging out of reach of children or animals to avoid risk of choking or suffocation.

## PACKAGE

Please read the following instructions carefully for the best experience. Cushions were vacuum packed and sealed for shipping, In order to boost the rebound process, please follow the steps below.



Open the vacuum bag carefully.

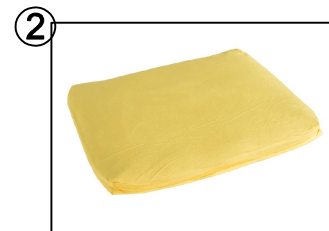

Initial look.

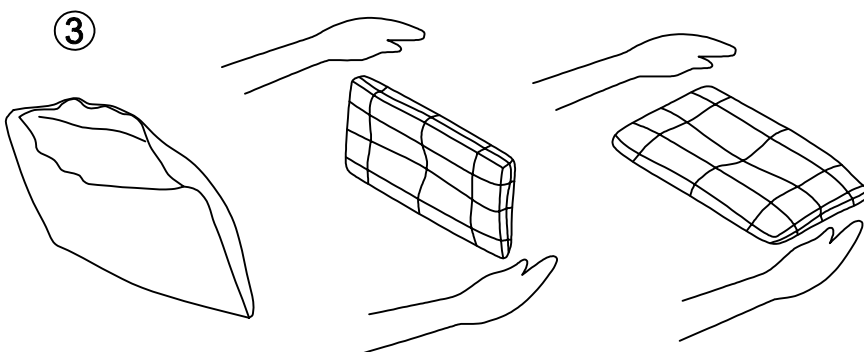

Open the zip, repeatedly tap the sides, front and back to make it rebound better and fluffy.

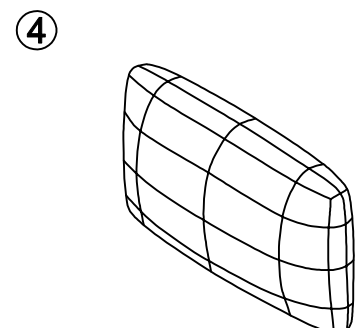

Repeat step 3 until the sponge is fully expanded, and zip the cover. Wait to rebound after 72 hours at least.

## CAUTION:

- Please do not open the compress packaging until your sofa frame is completely assembled.
- Compress cushions or pillows need to fully fluffed within 72 hours for your perfect use.
- Please keep children away from plastic bag or any small pieces of stuff.
- After assembly is completed, don't forget to pat the back cushions and seat cushions, make them recovering better. And wait 72 hours for fully rebound.
- Cushions should be regularly maintained for perfect use.
- 2 people to install is recommend.
- 2 people to lift the sofa if you want to move it, do not push or pull directly
- You can assemble it with out packaging tools or home electric drill, as shown below, Electric Drill tool is not included.
- Electric drill will improve your assembling efficiency.
- You can use it if you have this tool, DO NOT overtight to prevent from damaging screws and slats/boards.

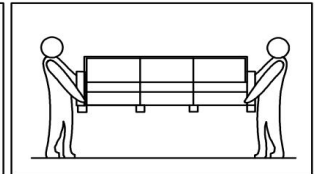
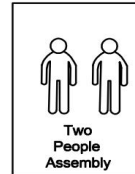
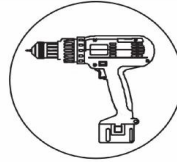



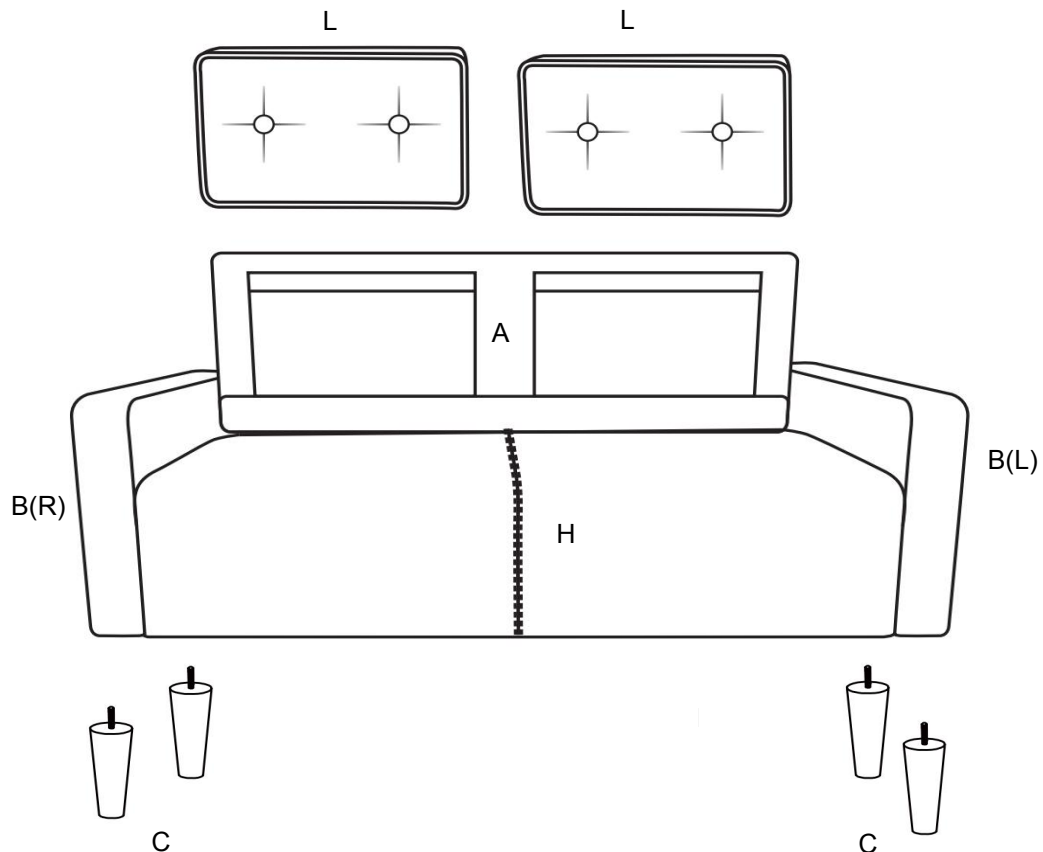

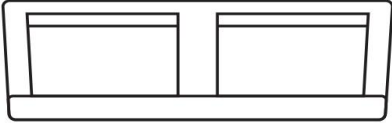
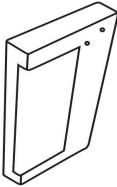
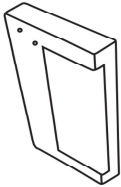
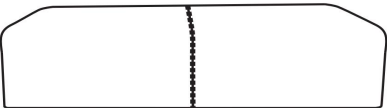
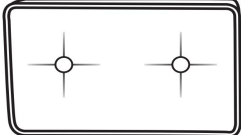

## Components:

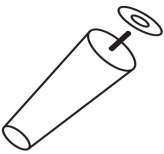

# PART LIST

 <p><b>A</b> 1PC</p>	 <p><b>B(L)</b> 1PC</p>	 <p><b>B(R)</b> 1PC</p>
 <p><b>H</b> 1PC</p>	 <p><b>L</b> 2PCS</p>	

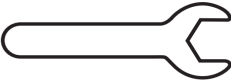
# HARDWARE LIST

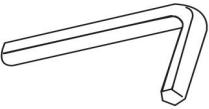
 <p><b>C</b> 4PCS</p>	 <p><b>D</b> 4PCS</p>	 <p><b>E</b> 8PCS</p>
 <p><b>I</b> 12PCS</p>	 <p><b>F</b> 1PC</p>	 <p><b>G</b> 8PCS</p>
 <p><b>J</b> 1PC</p>		

Step 1, Screw into the armrest "B(L)" & "B(R)" about 2cm.

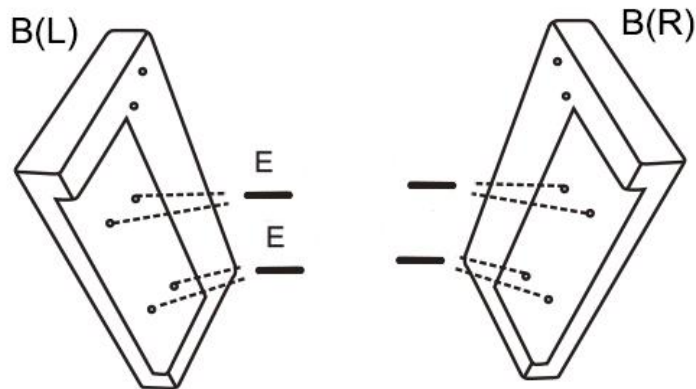

Step 2, Insert the armrest with screws into the seat frame "H", put the washer "I" and tighten the nuts "G" with wrench "F" from inside.

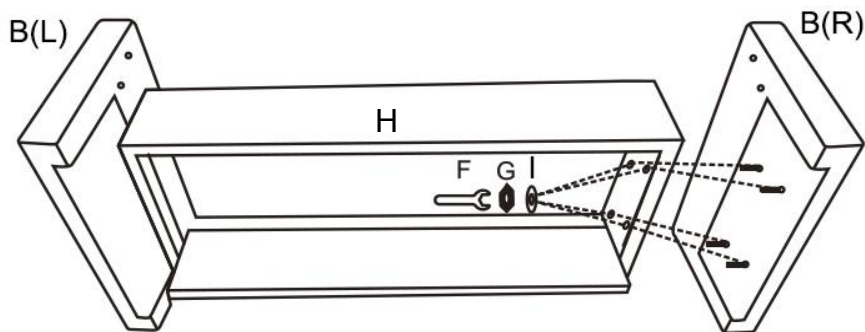

Step 3, Assemble the back frame "A" from the back side. Open the zipper on sofa back, align the holes, put the washer "I" and bolt "D", then tighten with wrench "J". Zip the cover after finished.

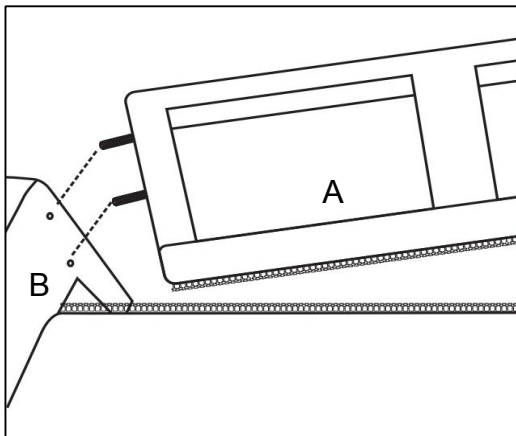

Front view

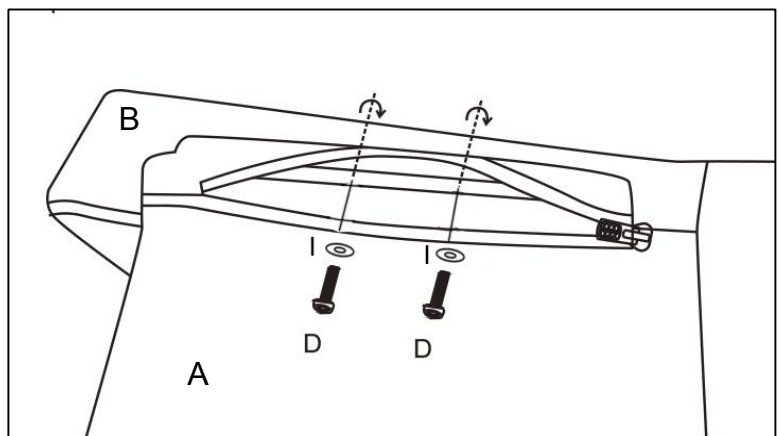

Back view

Step 4, Zip the fabric cover between seat and back.

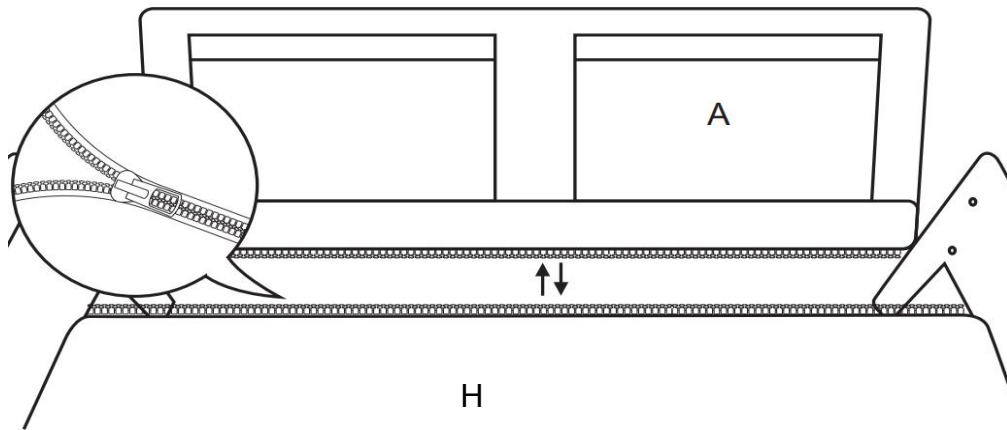

Step 5, Assemble the legs "C".

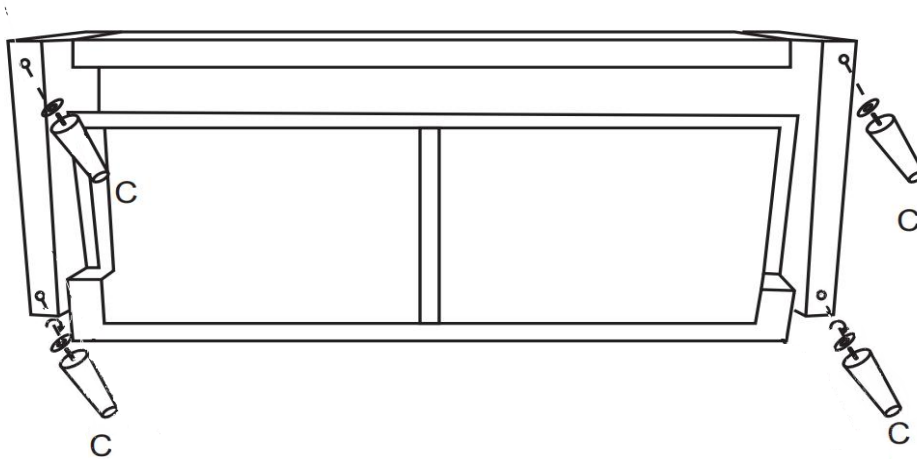

Step 6, Put the cushions "L" on sofa, and the assembly is completed.

