

Model: _____

Lot No: _____

Date of Purchase: _____



WARNING: This product may contain small components, please ensure they are kept away from small children.

PARTS AND HARDWARE

Avoid using sharp objects such as a knife to cut open packing as you may accidentally damage the upholstery.

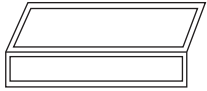

A. Seat (Loveseat)

1x

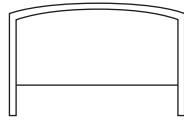

B. Backrest (Loveseat)

1x

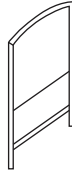

C. Armrest/ Legs

6x

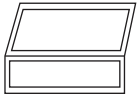

D. Seat (Single Seater)

2x

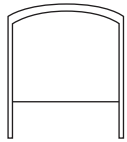

E. Backrest (Single Seater)

2x

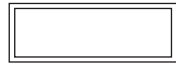

F. Front / Back Panel (Coffee Table)

2x

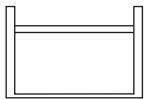

G. Side Panel / Legs (Coffee Table)

2x

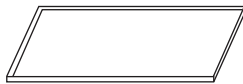

H. Table Top (Coffee Table)

1x



H. Bolts / Washers

50x 50x



F. Allen Key

1x

ASSEMBLY INSTRUCTIONS (Coffee Table)

Do not fully tighten bolts until assembly is complete.

1. Place Table Top (H) on floor face down.

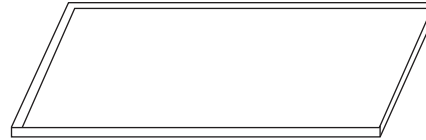

2. Affix washers to bolts (I), assemble side panels / legs (G) on each side of the table top (H). Do not fully tighten bolts.

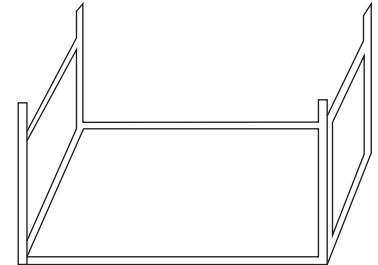

3. Affix washers to bolts (I), assemble front / back panels (F) on the table as shown in Figure below.

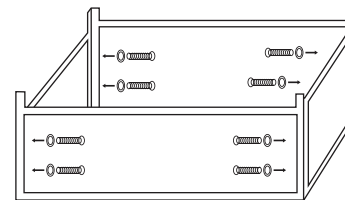

4. Tighten all bolts completely.

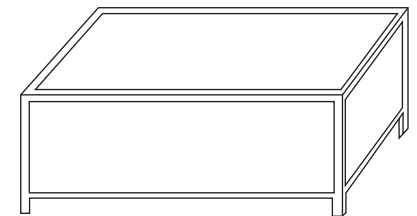

 x 12 Used

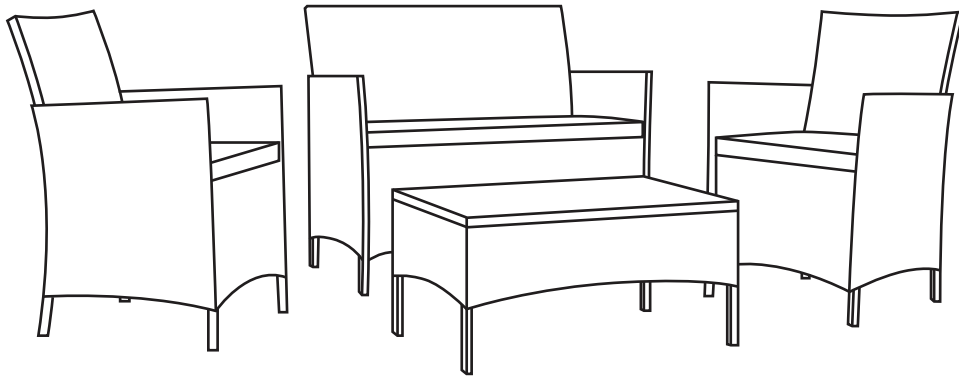

ASSEMBLY INSTRUCTIONS (Loveseat)

5. Locate seat (Loveseat) (A).

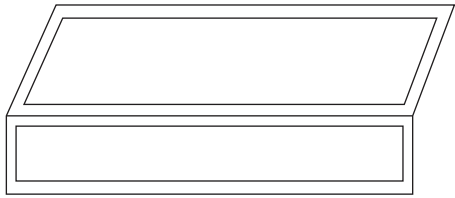

6. Affix washers to bolts (I), assemble legs / arms (C) on each side of the loveseat (A). Do not fully tighten bolts.

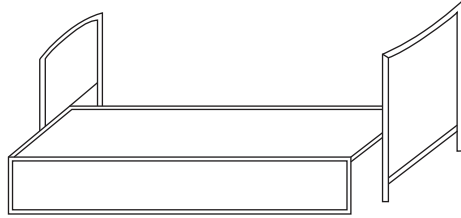

7. Affix washers to bolts (I), assemble backrest (Loveseat)(B) to the back of seat (A) as shown in Figure below.

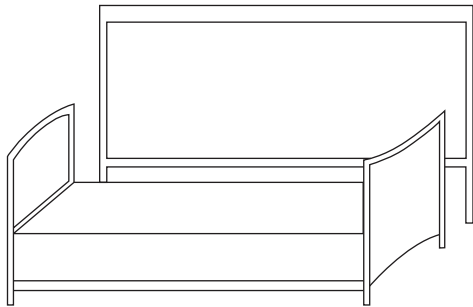

8. Tighten all bolts completely.

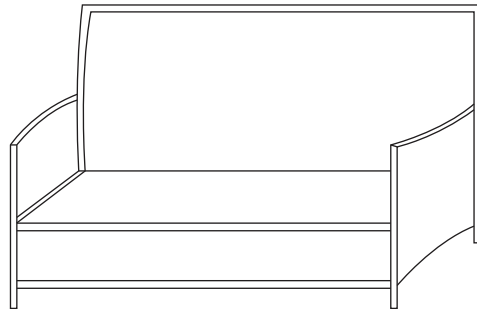

 x 14 Used

ASSEMBLY INSTRUCTIONS (Single Seater)

9. Locate seat (Single Seater) (D).

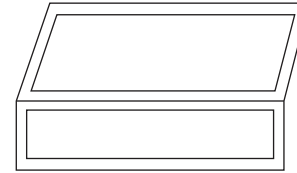

10. Affix washers to bolts (I), assemble legs / arms (C) on each side of the seat (D). Do not fully tighten bolts.

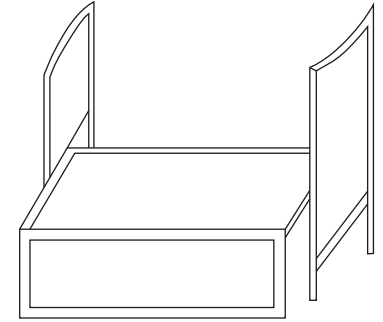

11. Affix washers to bolts (I), assemble backrest (single Seater) (E) to the back of seat (D) as shown in Figure below.

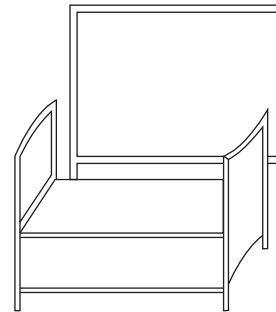

12. Tighten all bolts completely.

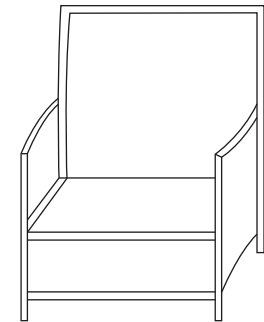

13. Repeat steps 9-12 for the second Single Seater.

 x 12*2 Used