

ASSEMBLY INSTRUCTION

DINING TABLE, PAPER TOP

PART LIST:

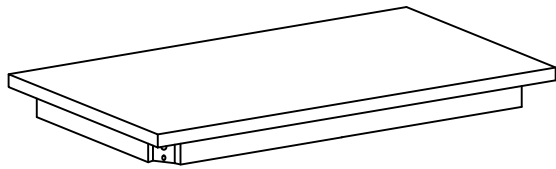

Table top
1pc

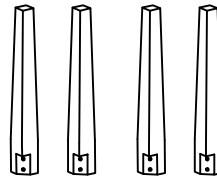



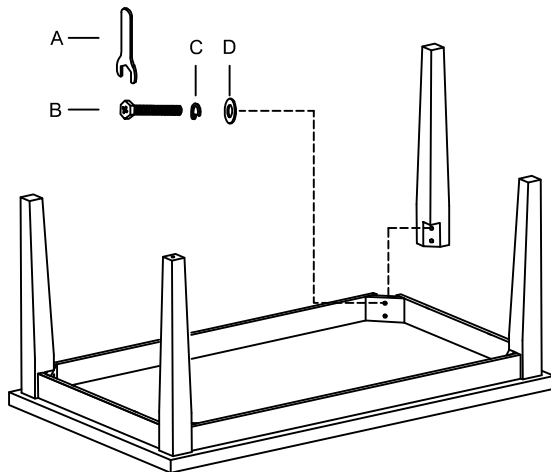

Table leg
4pcs

HARDWARE LIST				
A		Allen Wrench	12mm	1 PC
B		Bolt	Ø5/16"x2-3/4"	8 PCS
C		Spring Washer	Ø5/16"	8 PCS
D		Flat Washer	Ø5/16"xØ23mm	8 PCS

STEP 1



COMPLETED

