

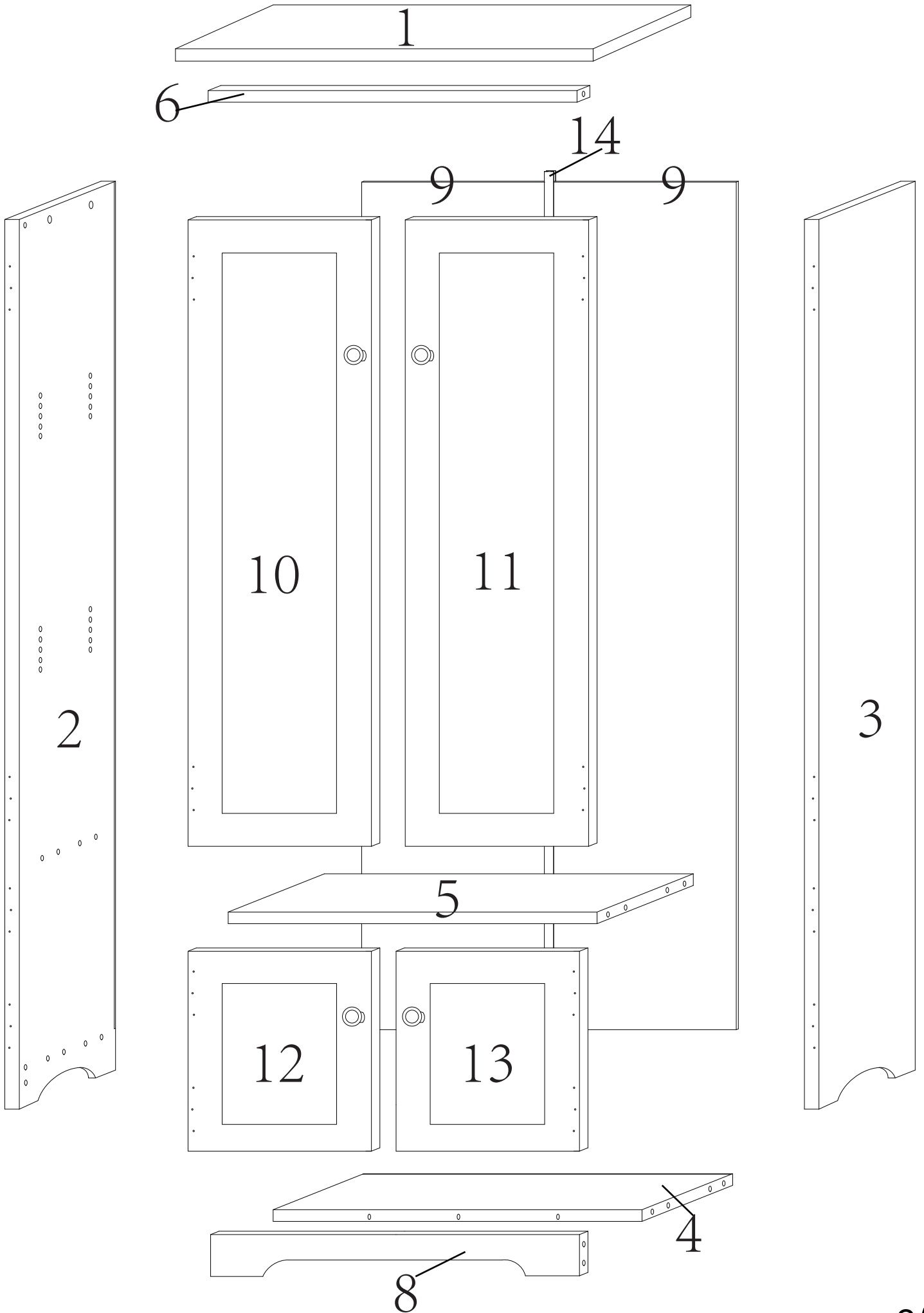













Thank you for purchasing our product!

Please assemble the products with the guidance of this manual instruction. Contact our friendly customer service department with any comments or in case there is any missing or damaged parts or hardware. Replacements for missing or damaged parts or hardware are normally shipped within 2 to 3 days.











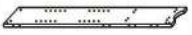

We appreciate your business!



Hardware List

ITEM	DESCRIPTION	PART	QTY
A	Wooden Dowel (Φ 6*30mm)		20PCS
B	Long Camlock Bolt		13PCS
C	Big Camlock		13PCS
D	Screw		4PCS
E	Door Handle		4PCS
F	Screw (Φ 3*12mm)		48PCS
G	Screw (Φ 3*15mm)		4PCS
H	Screw (Φ 3*12mm)		22PCS
I	Hinges		8PCS
J	Screw (Φ 3.5*25mm)		6PCS
K	Magnetic catch		2PC
L	Magnetic Bar		4PCS
M	Shelf pin		8PCS

PART List

ITEM	DESCRIPTION	PART	QTY
1	Top Panel		1PC
2	Left Panel		1PC
3	Right Panel		1PC
4	Bottom Panel		1PC
5	Upper Shelf Panel		1PC
6	Lower cross bar		1PC
7	Adjustable shelf		2PCS
8	Bottom Rail		1PC
9	Back panel		2PCS
10	Big Left Door		1PC
11	Big Right Door		1PC
12	Small Left Door		1PC
13	Small Right Door		1PC
14	Plastic Strip		1PC

Assembly of camlock

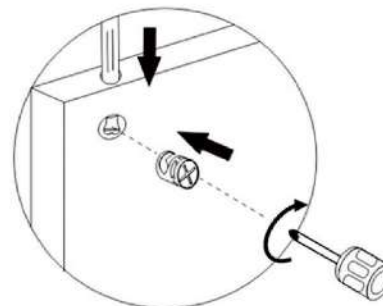
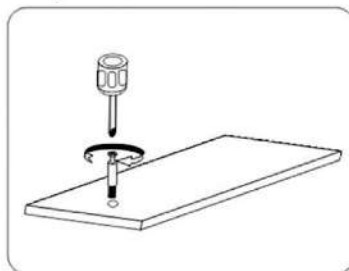

Screw camlock bolt to wood part

Do not tighten camlock unless is instructed

To assemble camlock , ensure long side of the + is facing the bolt
before inserting into hole

Note:

- 1) Please be advised to have at least 2 persons to assemble this unit.
- 2) Tools not included, but essential for assembling this unit :

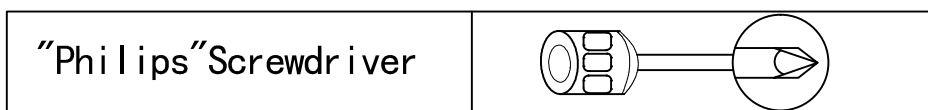

- 3) Place a large cloth or blanket on the floor or flat surface to protect parts from scratching .
- 4) Before assembling this unit , please check that all parts and hardware are present .

STEP 1

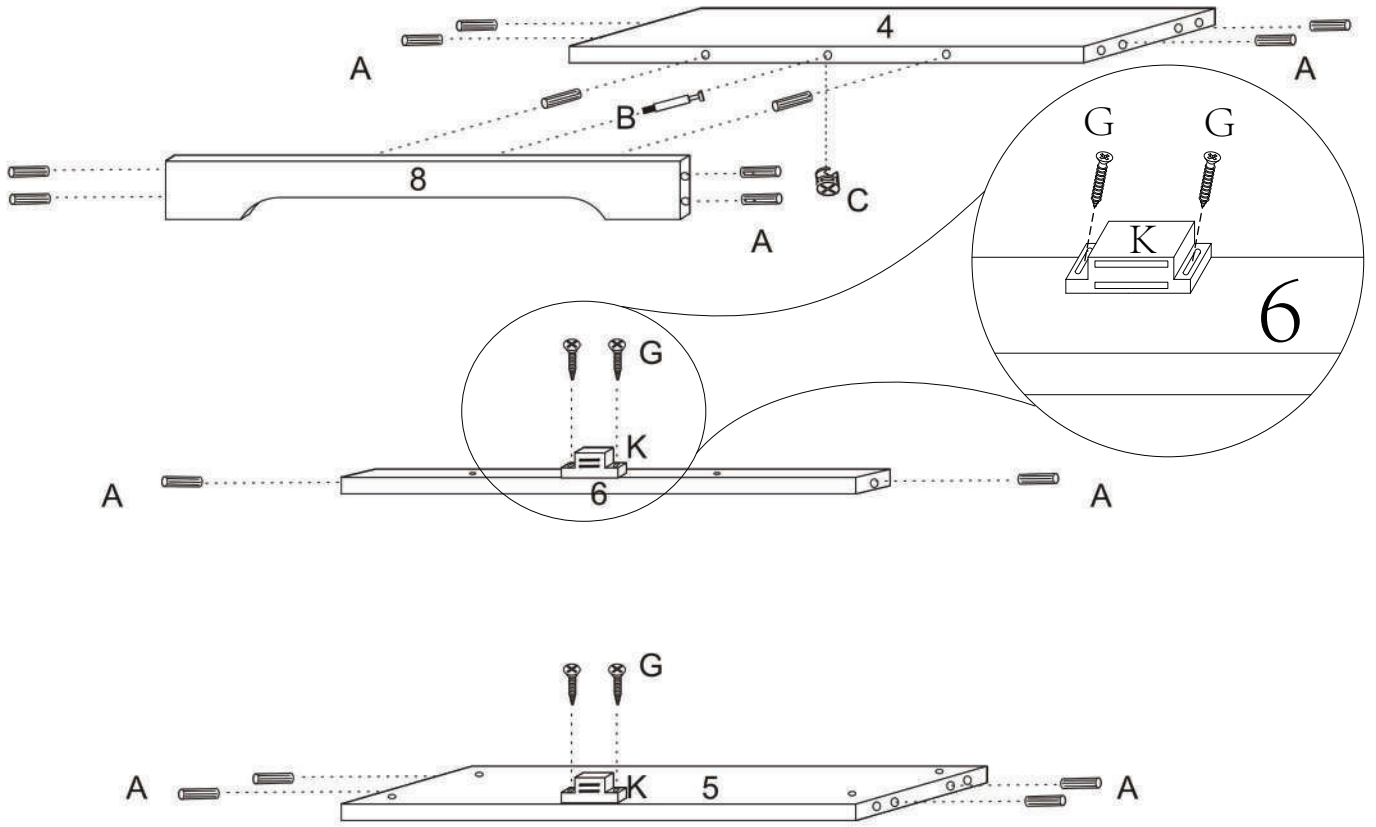

STEP 2

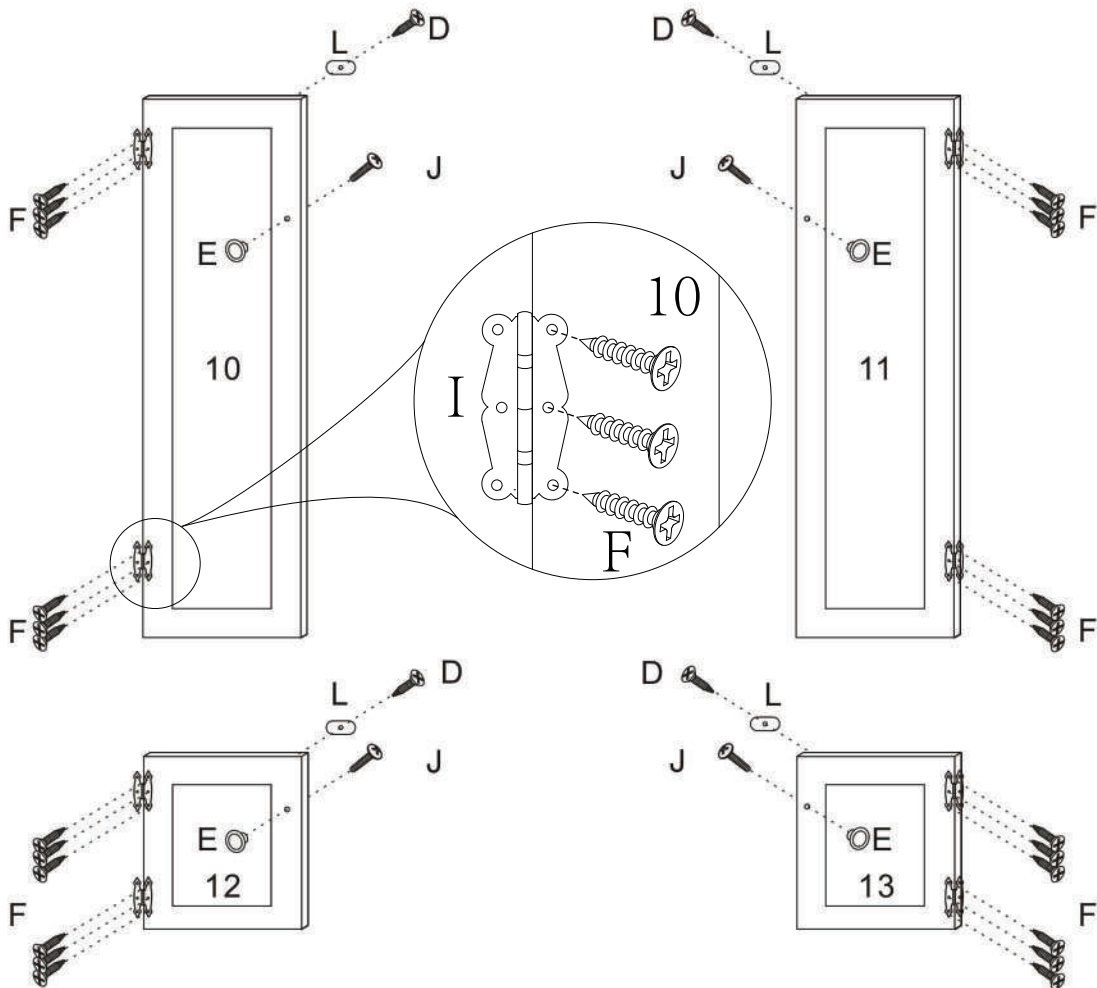

STEP 3

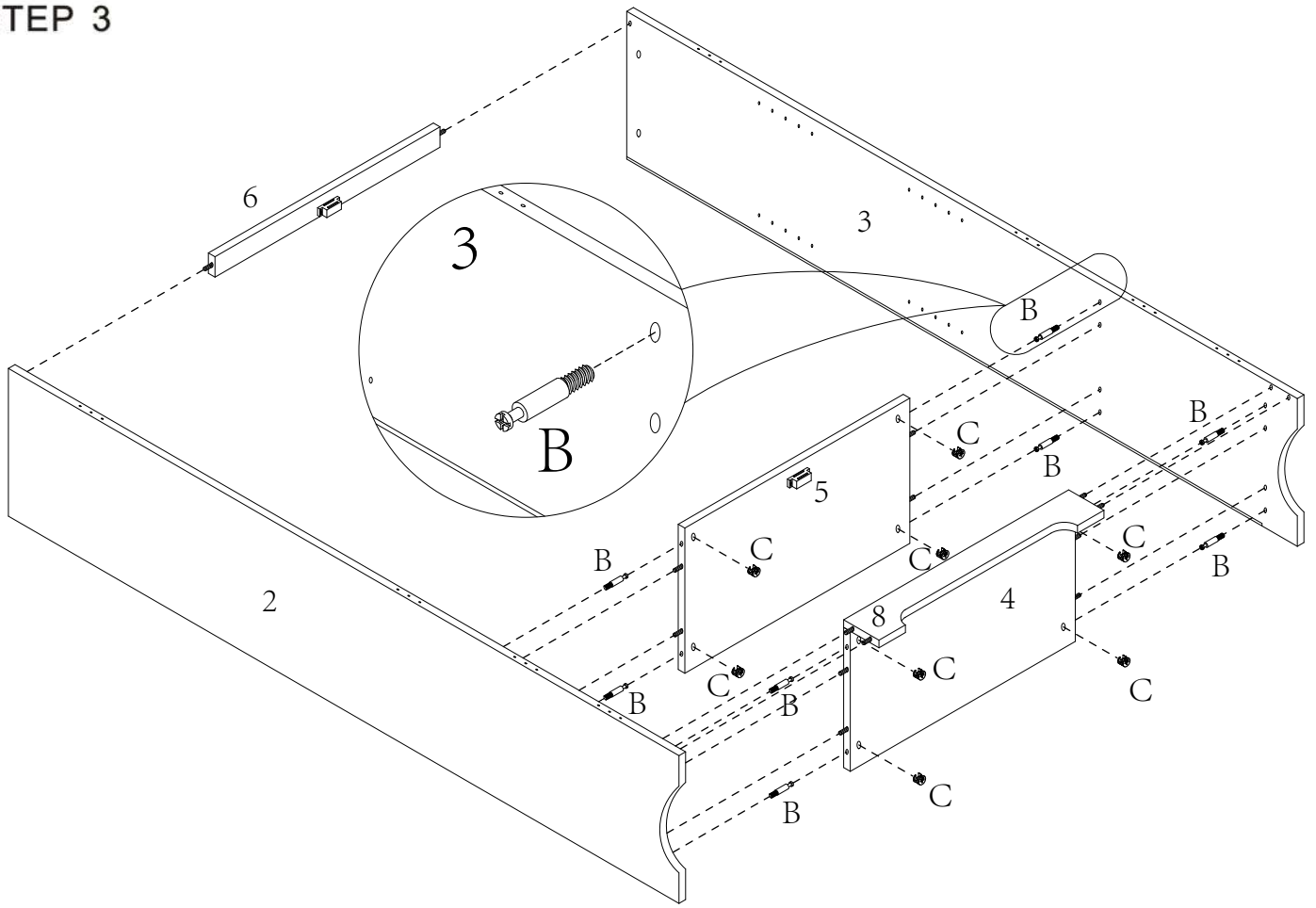

STEP 4

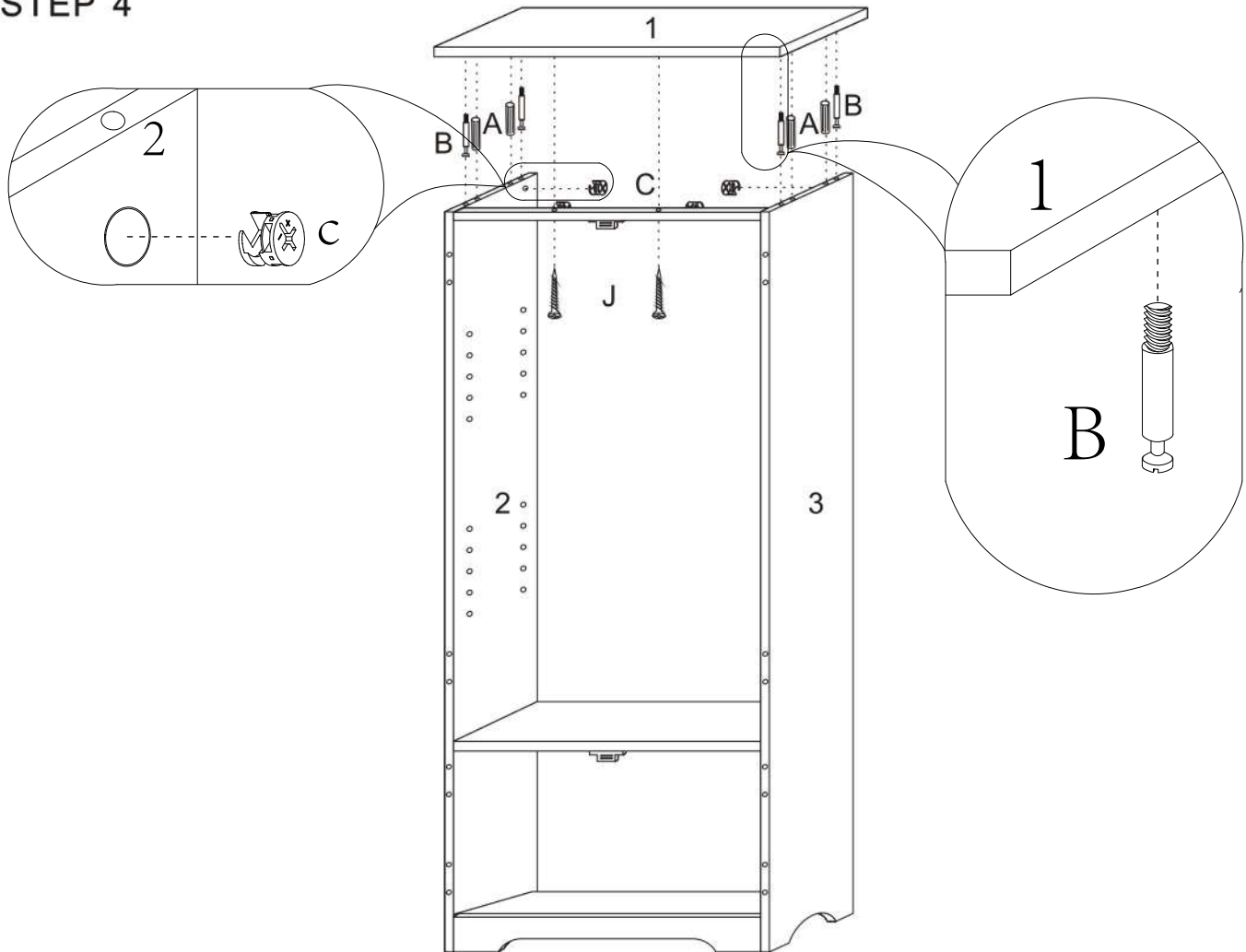

STEP 5

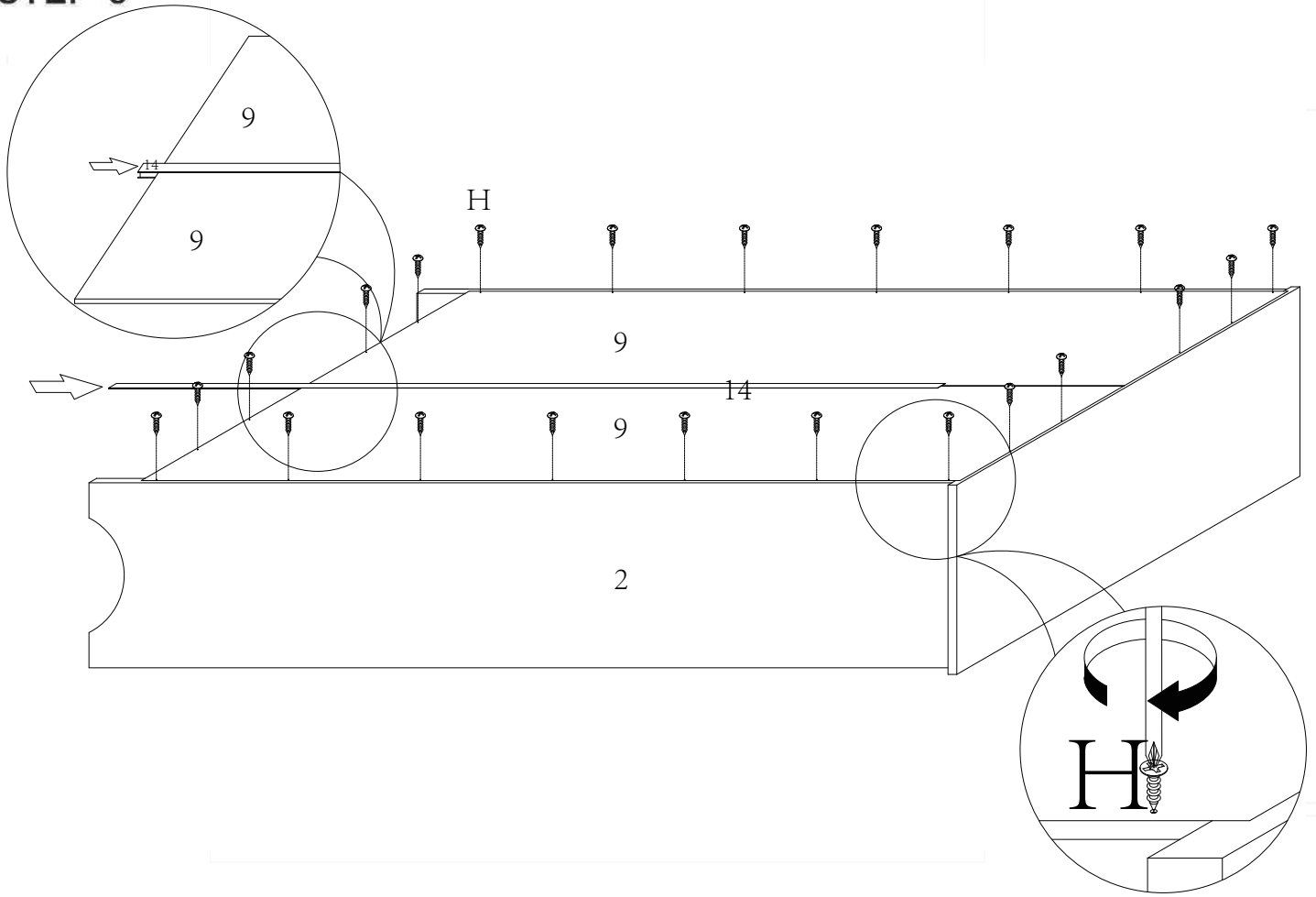

STEP 6

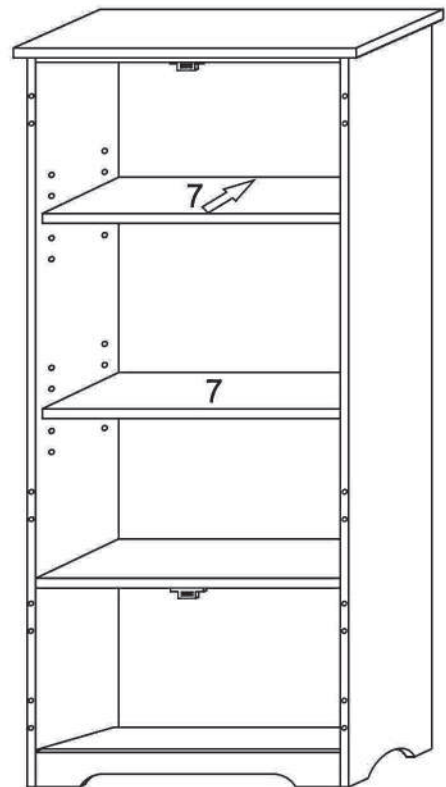
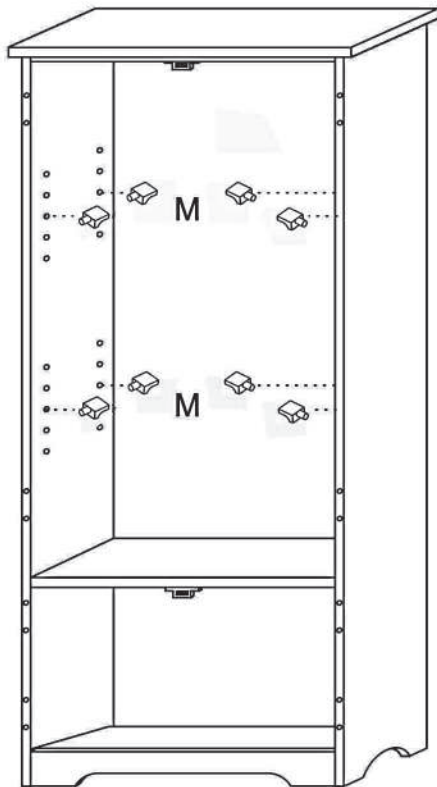

STEP 7

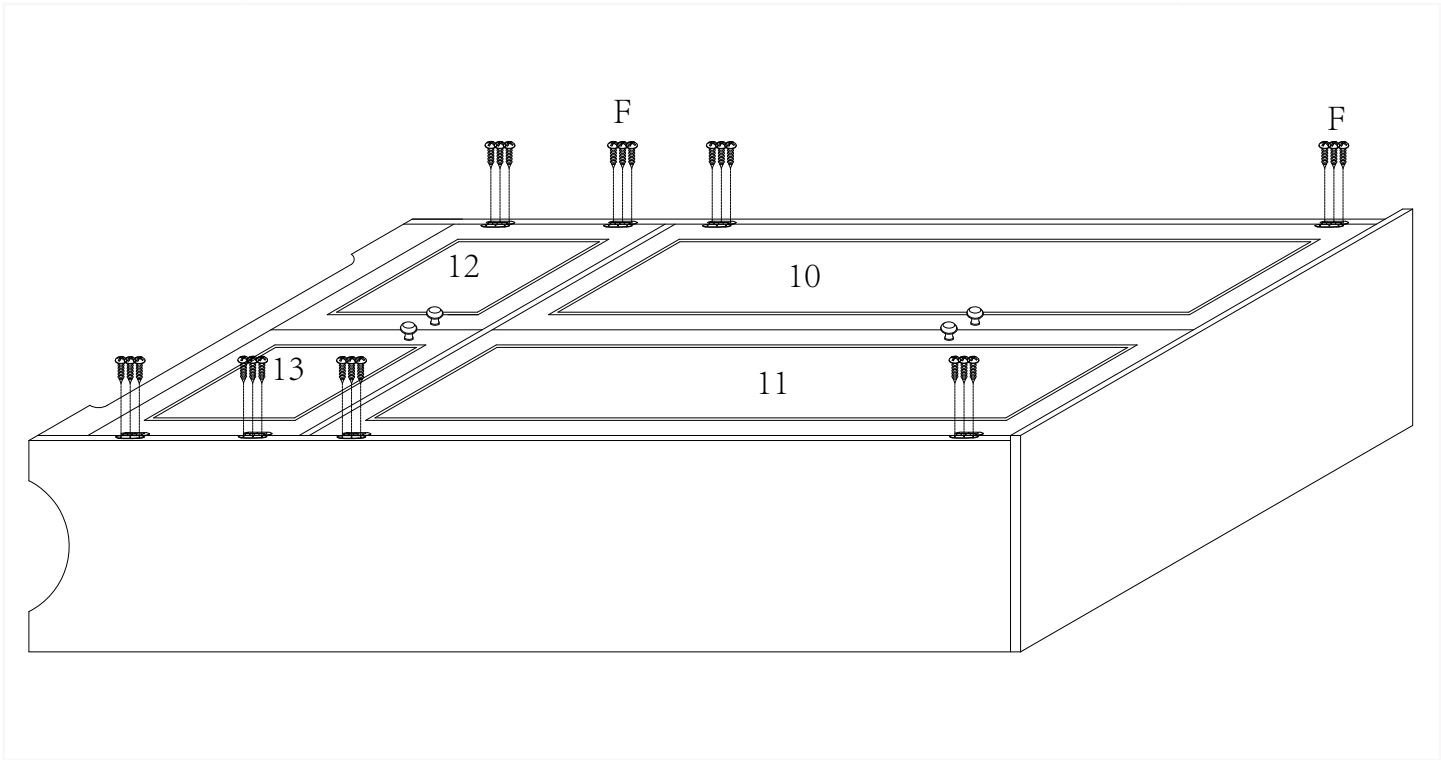

STEP 8

