

ASSEMBLY INSTRUCTION

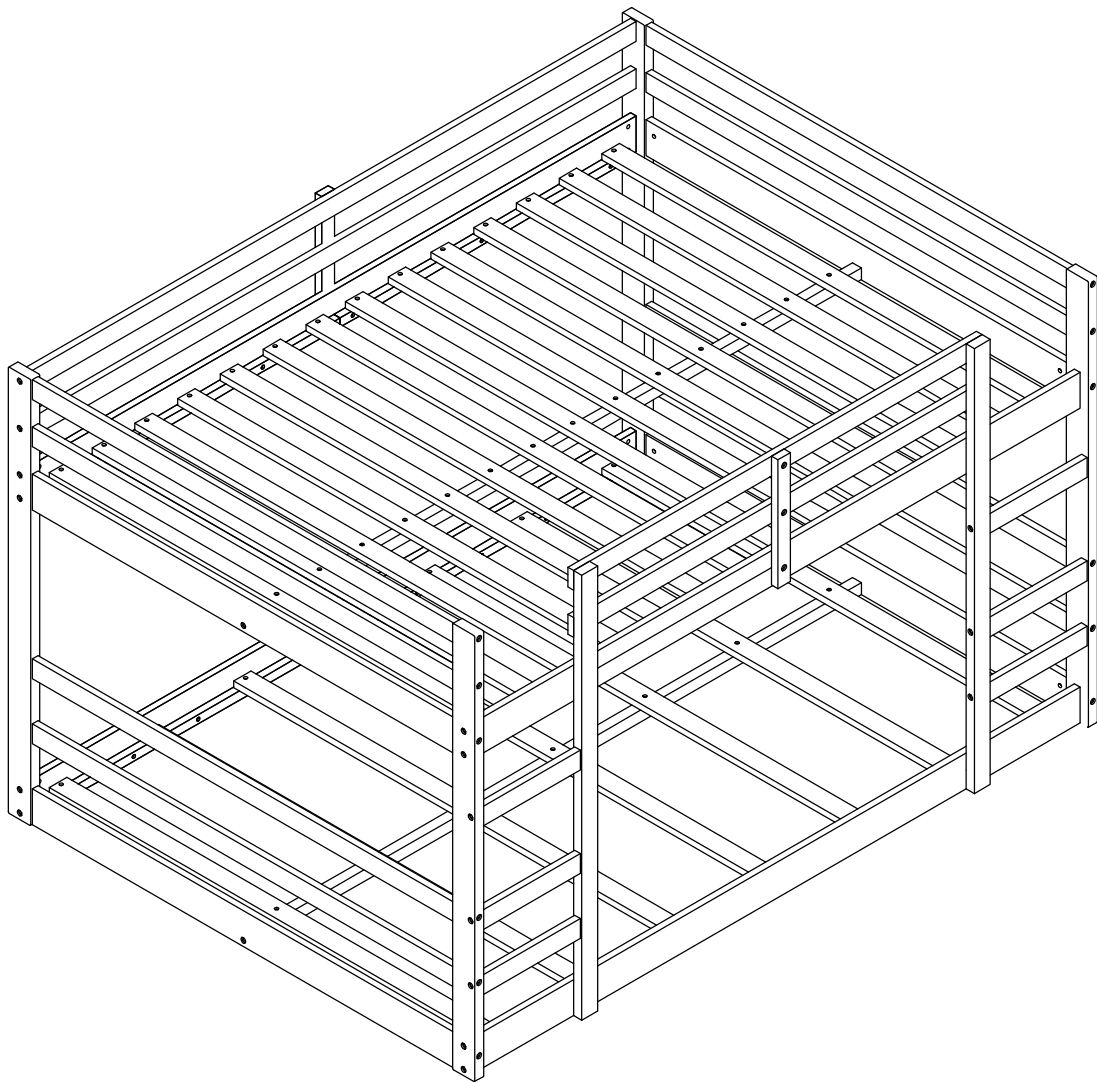



SAFETY WARNINGS



1. This bed is designed for use only mattress(es) meeting the following specifications on the upper bunk, and lower bunk:

Upper bunk (bunk bed and tribed included)

Bed Type	Length	Width	Thickness
<i>Full Standard</i>	74"-75"	53"-54"	6" max

Lower bunk

Bed Type	Length	Width	Thickness
<i>Full Standard</i>	74"-75"	53"-54"	8"

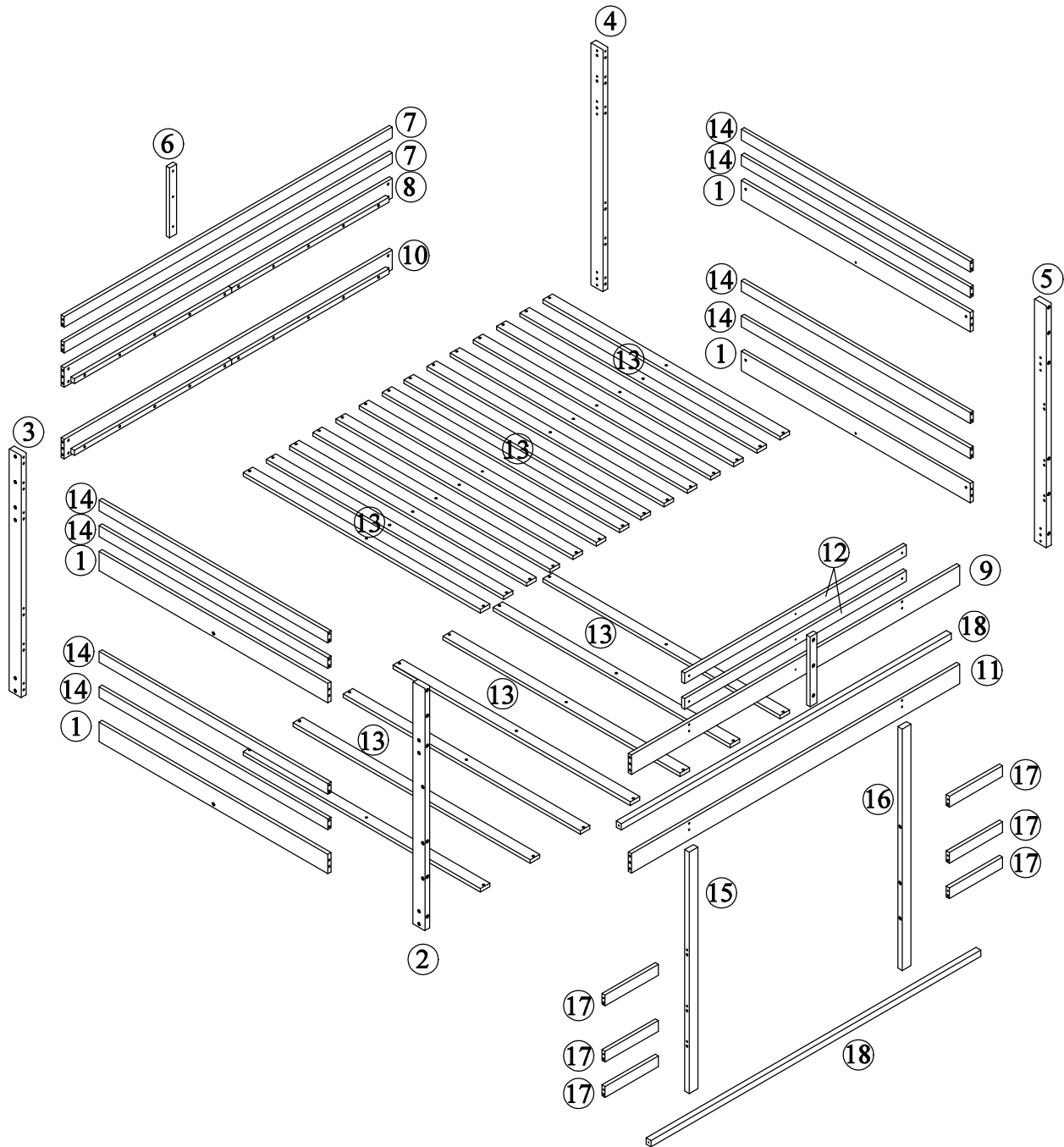

2. Replacement parts, including additional guardrails, maybe obtained from any of our (GIGACLOUD TECHNOLOGY (USA) INC. 18961 ARENTH AVENUE CITY OF INDUSTRY, CA, 91748) dealers.
3. Follow the information on the warnings appearing on the upper bunk bed end structure and on the carton. Do not remove warning label from bed.
4. Always use the recommended size mattresses or mattress supports, or both, to help prevent the likelihood of entrapment or falls.
5. Surface of the mattress must be at least 5" . (127 mm) below the upper edge of guardrails.
6. Do not allow children under 6 years of age to use the upper bunk.
7. Periodically check and ensure that the guardrail, ladder, and other components are in their proper position, free from damage, and that all connectors are tight.
8. Do not allow horseplay on or under the bed and prohibit jumping on the bed
9. Always use the ladder for entering and leaving the upper bunk.
10. Do not use substitute parts. Contact the manufacturer or dealer for replacement parts.
11. Use of a night light may provided added safety precaution for a child using the upper bunk.
12. Always use guardrails on both long sides of the upper bunk. If the bunk bed will be placed next to the wall, the guardrail that runs the full length of the bed should be placed against the wall to prevent entrapment between the bed and wall.
13. The use of water or sleep flotation mattresses is prohibited.
14. STRANGULATION HAZARD – Never attach or hang items to any part of the bunk bed that are not designed for use with the bed; for example, but not limited to, hook, belts and jump ropes.
15. Keep these instructions for future reference
16. Prohibit more than one person on upper bunk.
17. We recommend assembling your bunk bed on the shipping carton to protect your floor or carpet.
18. Be certain all staples are out of the box before beginning assembly on the shipping carton.

Detail View - DOUBLE FULL BED





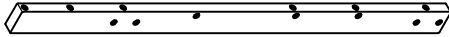
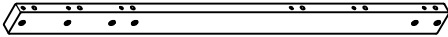
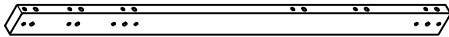
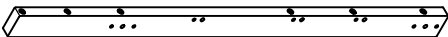
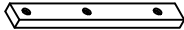
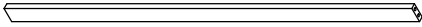
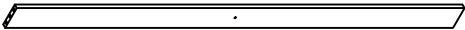
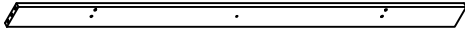
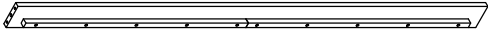
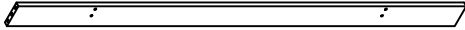



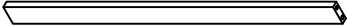
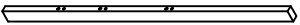
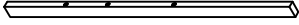
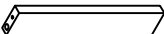
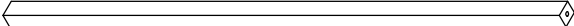

Identifying the Hardware-Identify the hardware using the illustrations below.

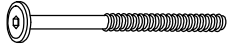
Part List

<p>1</p>  <p>Horizontal board - 4pcs</p>	<p>2</p>  <p>Left front bed column - 1pc</p>
<p>3</p>  <p>Left rear bed column - 1pc</p>	<p>4</p>  <p>Right rear bed column - 1pc</p>
<p>5</p>  <p>Right front bed column - 1pc</p>	<p>6</p>  <p>Support timber -2pcs</p>
<p>7</p>  <p>Rear guard rail - 2pcs</p>	<p>8</p>  <p>Bed side plate - 1pc</p>
<p>9</p>  <p>Bed side plate - 1pc</p>	<p>10</p>  <p>Bed side plate - 1pc</p>
<p>11</p>  <p>Bed side plate - 1pc</p>	<p>12</p>  <p>Front guard rail - 2pcs</p>

<p>13</p>  <p>Bed board - 21pcs</p>	<p>14</p>  <p>Horizontal board - 8pcs</p>
<p>15</p>  <p>Ladder Left leg - 1pc</p>	<p>16</p>  <p>Ladder right leg - 1pc</p>
<p>17</p>  <p>Step of bed ladder - 6pcs</p>	<p>18</p>  <p>Reinforcement bar - 2pcs</p>

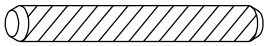

Hardware List

<p>A</p>  <p>ø13x1/4"x100mm</p>	<p>B</p>  <p>ø13x1/4"x64mm</p>	<p>C</p>  <p>ø13x1/4"x30mm</p>
<p>Hex-Head bolts(8pcs)</p>	<p>Hex-Head bolts(16pcs)</p>	<p>Hex-Head screw(18pcs)</p>
<p>D</p>  <p>ø13x1/4"x50mm</p>	<p>E</p>  <p>ø13*1/4"x70mm</p>	<p>F</p>  <p>ø13*1/4"x90mm</p>
<p>Hex-Head screw(8pcs)</p>	<p>Hex-Head screw(12pcs)</p>	<p>Hex-Head screw(16pcs)</p>
<p>G</p>  <p>ø10x13mm</p>	<p>H</p>  <p>ø8xø4x30mm</p>	<p>I</p>  <p>4mm</p>
<p>Horizontal-Hole bolts(24pcs)</p>	<p>Round head screw(63pcs)</p>	<p>Allen key(1pc)</p>
<p>J</p>  <p>ø10x40mm</p> <p>Wood dowel(48pcs)</p>		

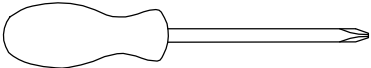
ASSEMBLY TOOLS REQUIRED (NOT INCLUDED)



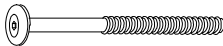

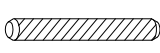

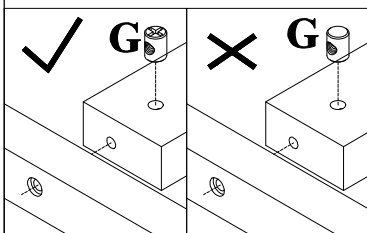
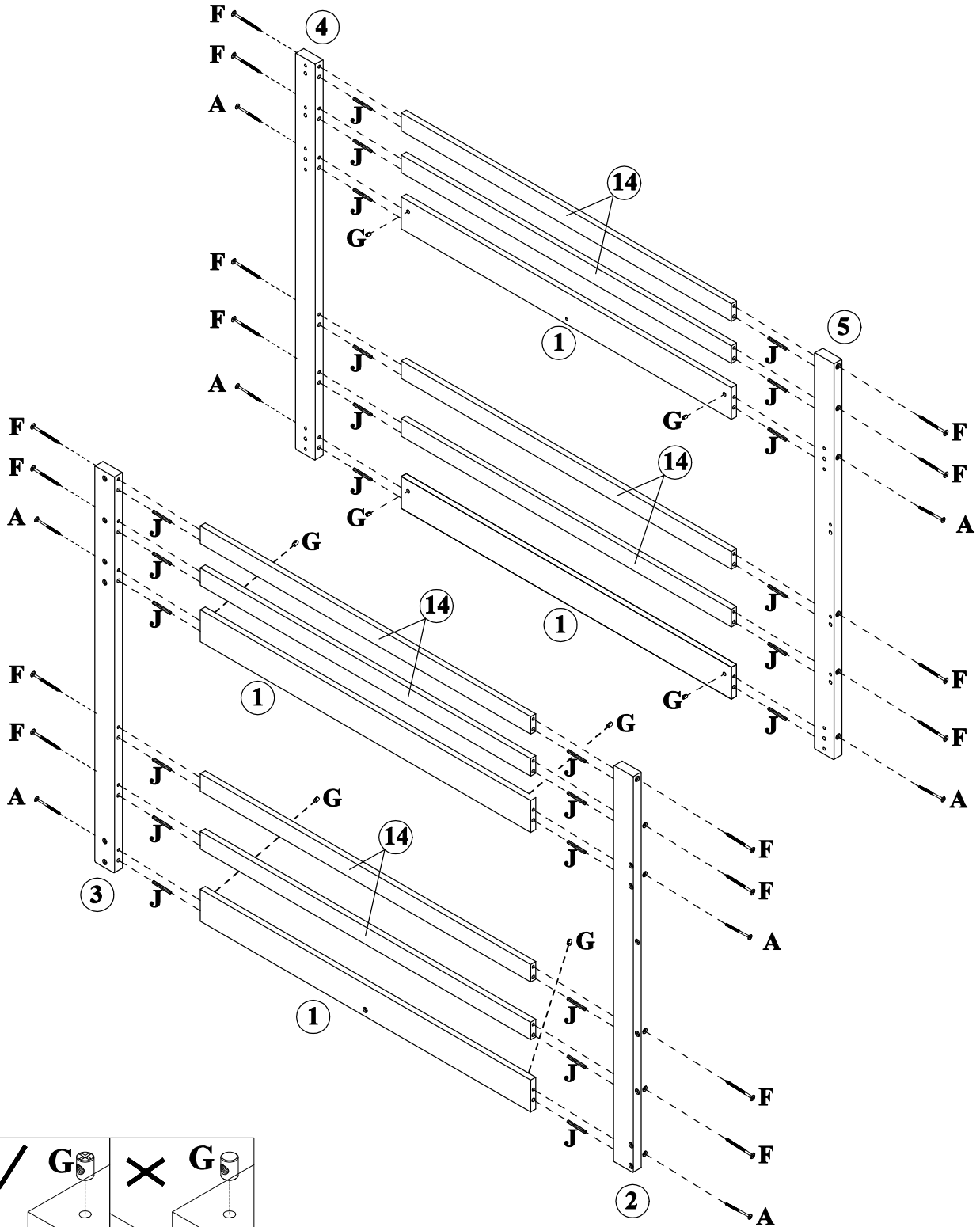
STEP: 1

A	F	G	J
			
8PCS	16PCS	8PCS	24PCS

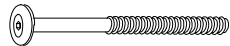

STEP: 2

B	C	D	G	J
				
16PCS	3 PCS	8 PCS	16PCS	12PCS

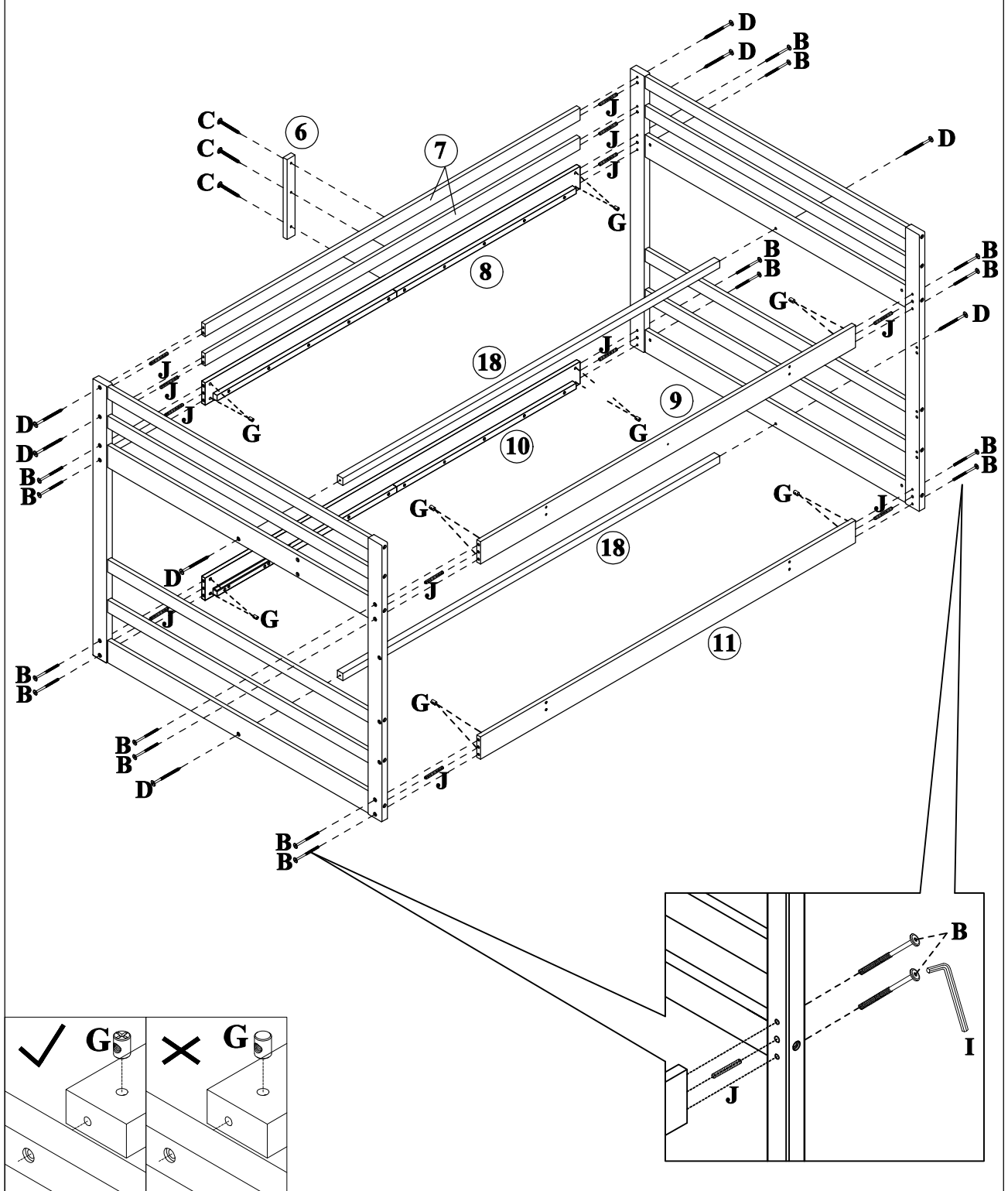

STEP: 3

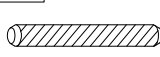
E 	J 
12 PCS	12PCS

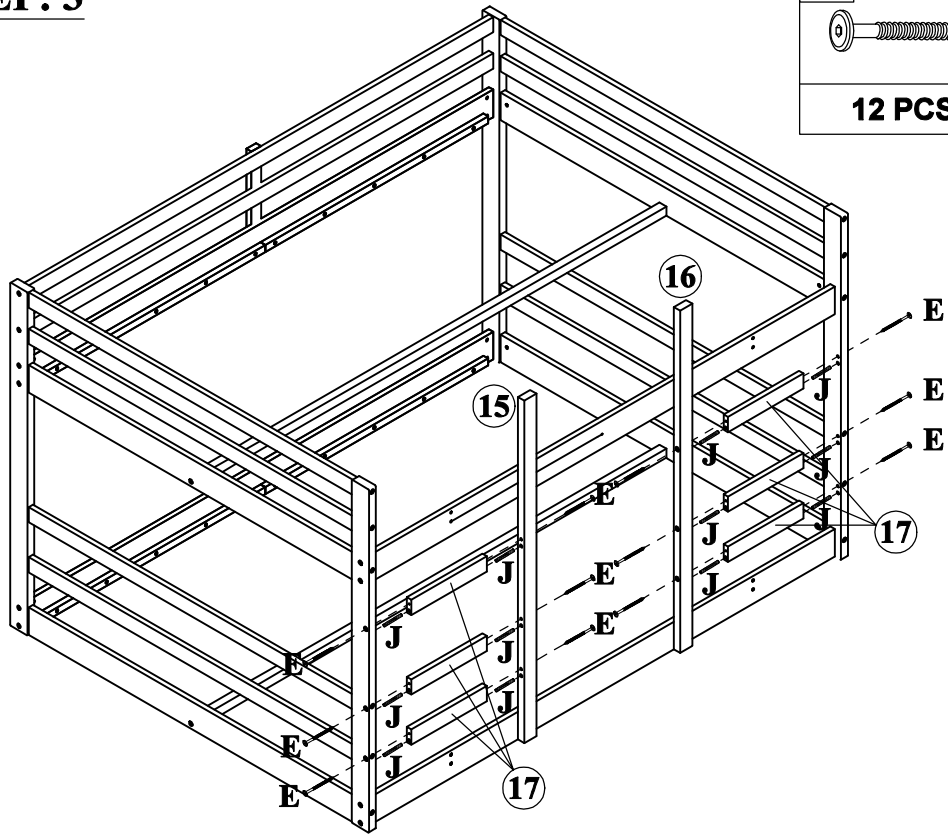

STEP: 4

C 
8 PCS

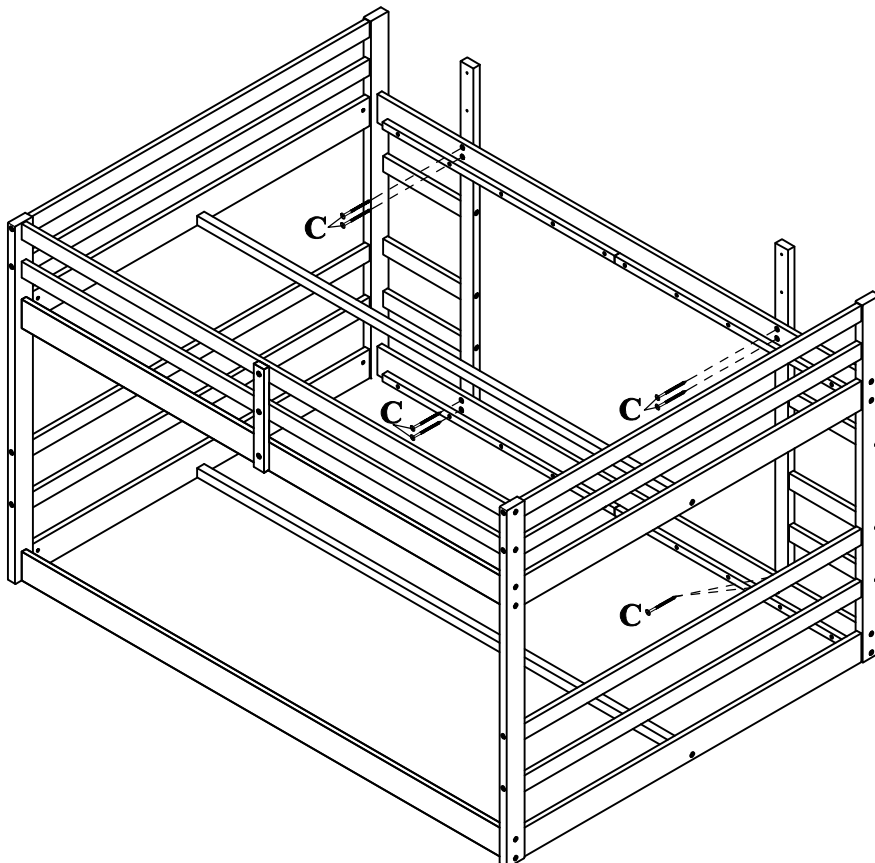

STEP: 5

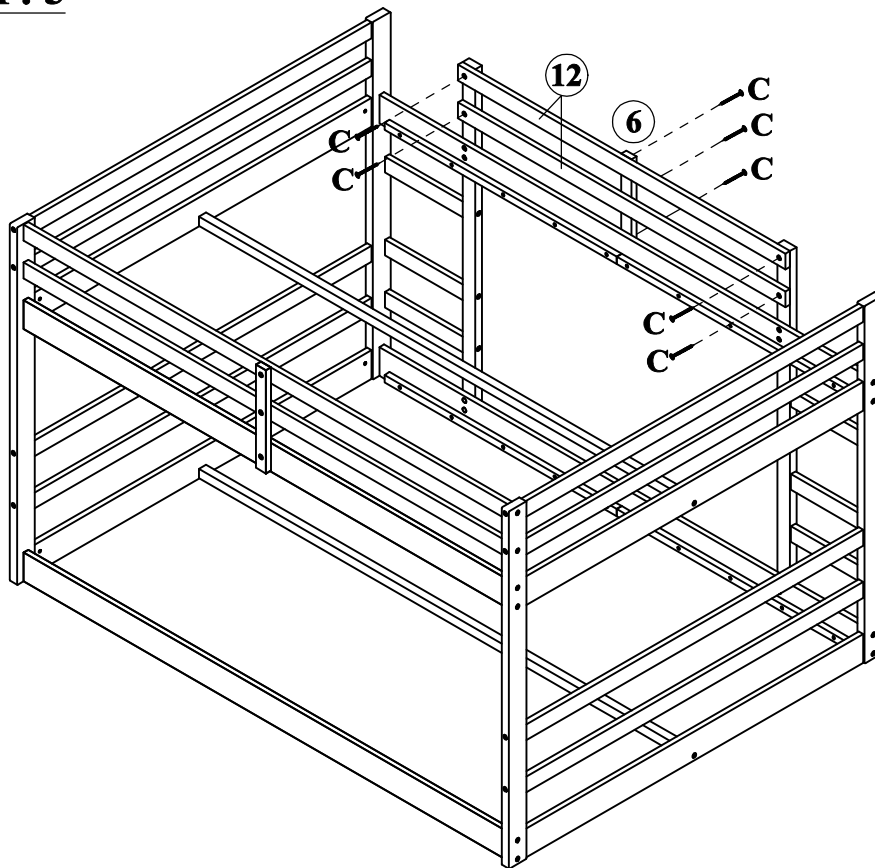

C



7 PCS

STEP: 6

No. 13

Install 14pcs on the upper bed
7pcs on the lower bed

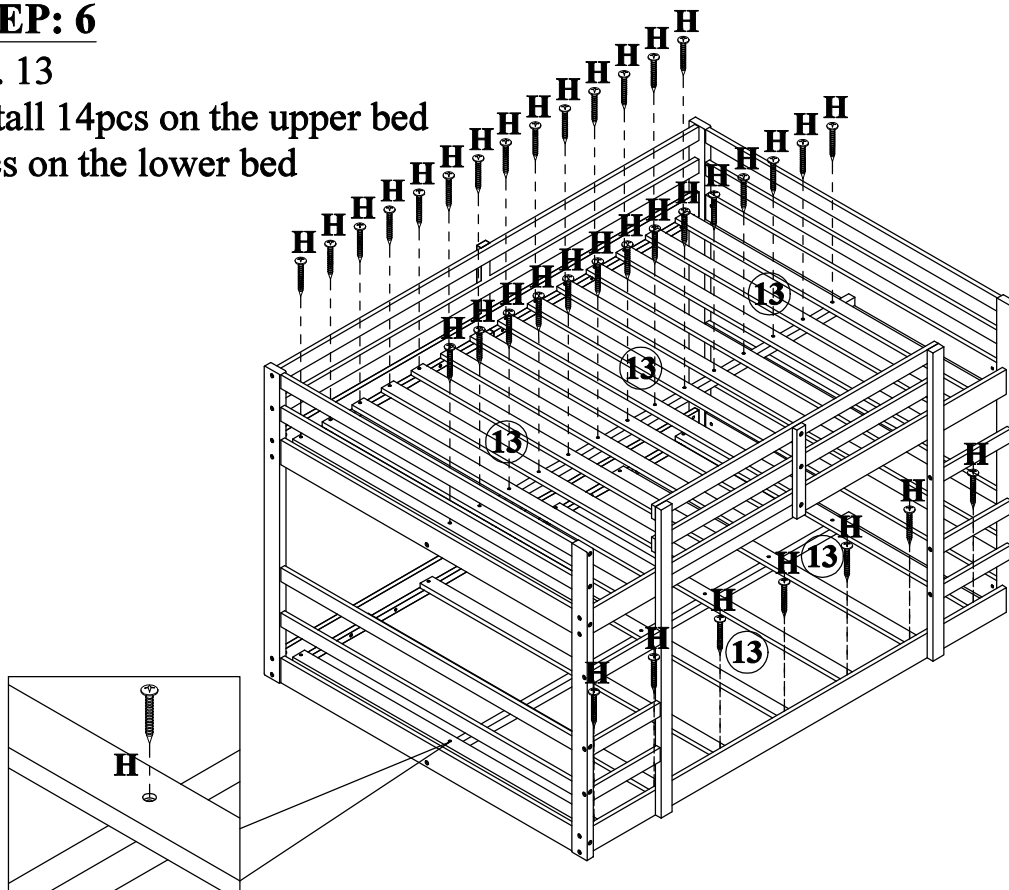

H



63PCS

STEP: 7

