

# INSTALLATION INSTRUCTIONS

## 12X20 ft Carport

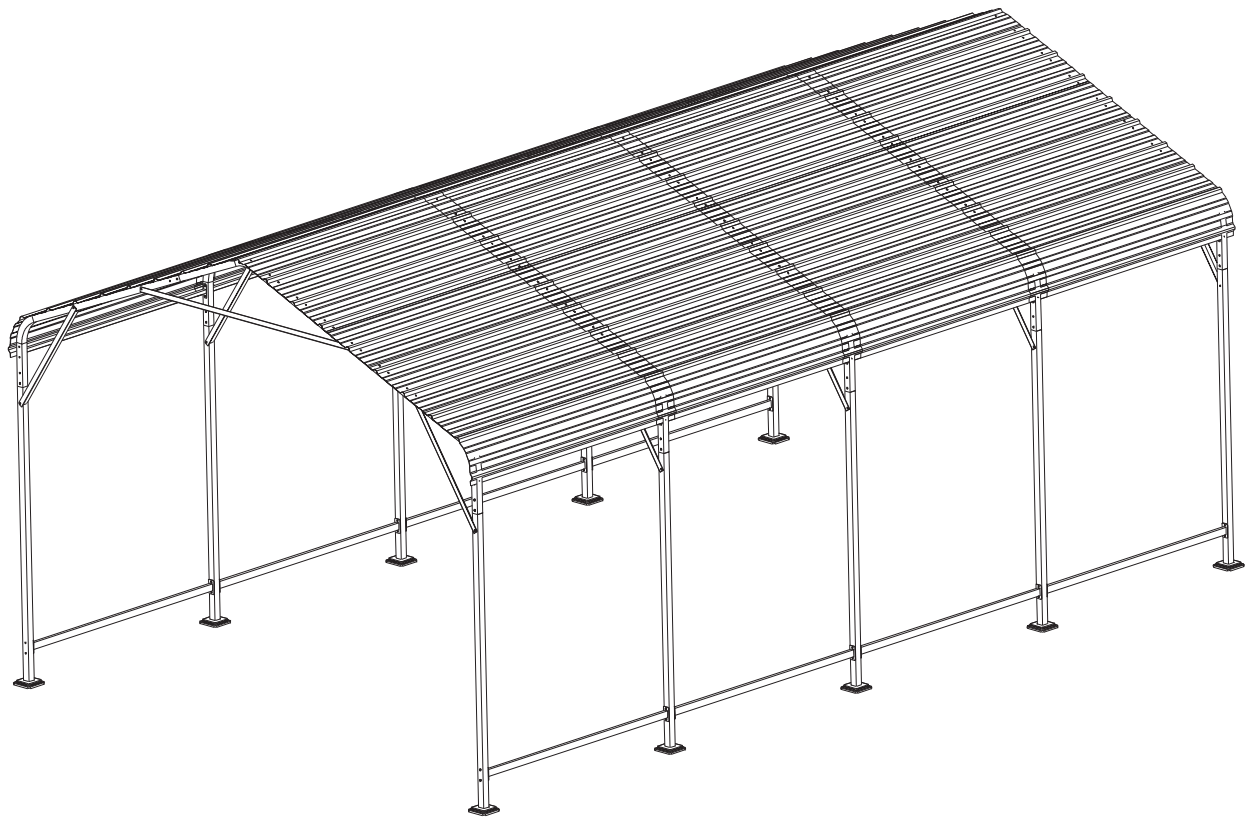

## **Get Ready:** Think Ahead!

**Prep Work:** Before you dive into setting up your new metal carport, make sure to check out your local building codes. These codes might have specific guidelines on footings, placement, and other key details. Don't skip this step!

**Understand the Guide:** We've put together detailed instructions for you. Take some time to go through them. They're packed with crucial info and handy tips that'll make your installation smoother and even more satisfying.

**Tools & Supplies:** You're going to need some basic tools and materials. The anchoring method and foundation type you choose will determine what exactly you'll need. So, make a comprehensive list based on your plan to stay organized.

## Before You Start Assembling

**Instruction Manual:** This manual's got everything you need for setting up your carport. Go through all the instructions before starting. As you assemble, following the steps in order is key to getting it right.

**Check Your Parts:** Make sure you've got all the necessary parts and the right quantities as listed. They should all be in your package, neatly packed within the carton. We've thrown in some extra fasteners too, just to make things easier for you.

**Exploded View Diagram:** This diagram shows all the parts (except screws and bolts). Look over everything before you start. Getting familiar with the hardware and fasteners now will save you time and hassle during installation.

# SAFETY PRECAUTIONS...

*Safety precautions MUST be followed at all times throughout the construction of your building!*

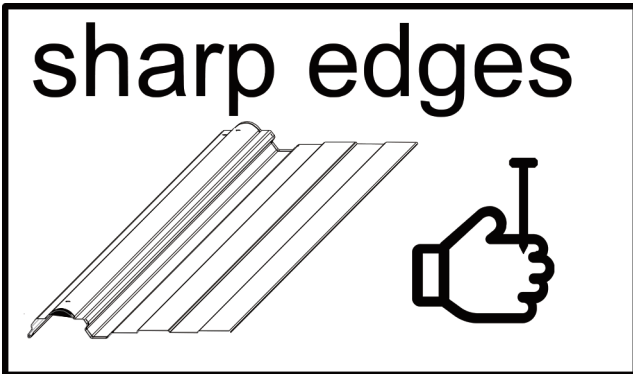

When working with your building's parts, which may have sharp edges, always wear work gloves and eye protection, and put on long sleeves. This helps prevent cuts and injuries during assembly or maintenance.



Exercise caution when using tools during assembly. It's particularly important to be well-versed in the use of any power tools involved in the process.



Ensure that children and pets are kept at a safe distance from the construction area until the building is fully assembled. This precaution minimizes distractions and reduces the risk of accidents.



**Wind Advisory:**  
Avoid assembling your building on a windy day. Large panels can act like sails in the wind, making them hard to control and posing safety risks during construction.

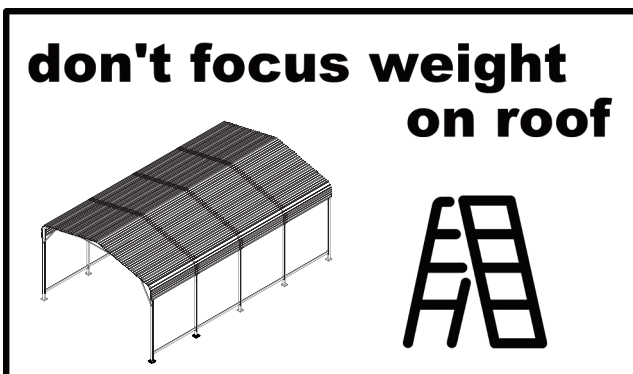

**Roof Safety Warning:**  
Never put your full weight on the building's roof. Always ensure that a step ladder is fully extended and placed on level ground before climbing it.

**Complete Check:**  
Before starting assembly, verify that you have all the parts and hardware listed. A partially assembled building can be vulnerable to damage, even from mild winds.

# ASSEMBLY TIPS & TOOLS

---

## Weather Awareness:

Choose a clear and calm day for your installation. Avoid building assembly on windy days, and be cautious if the ground is wet or muddy.

## Team Effort Required:

Assembling your building is a three-person job at minimum. One can hold parts or panels in place, while the other secures them and manages the tools, ensuring a quicker and safer assembly process.

## Gathering Your Tools and Supplies:

Prepare by listing the basic tools and materials necessary for assembly. Your choice of anchoring method and base type will determine the complete list of materials required.

---

### WHAT YOU NEED

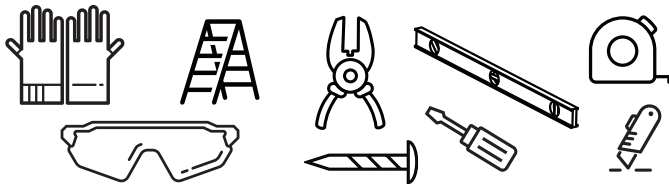

- Work Gloves
- Safety Glasses
- Step Ladder
- No. 2 Phillips Screwdriver (Magnetic Tip Preferred)
- Utility Knife or Scissors
- Pliers
- Carpenter's Level
- Tape Measure

### RECOMMENDED TIME SAVERS

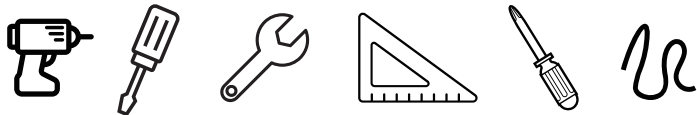

- Power Drill (Cordless, Variable Speed)
- Nut Driver or Wrench
- Square
- String (for squaring the frame)
- Awl (to align holes)

### BASE PREPARATION TOOLS

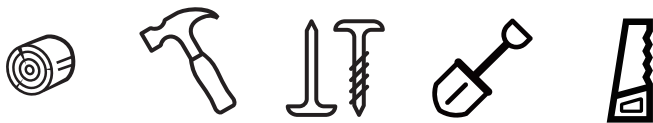

- Lumber and/or Concrete
  - Hammer and Nails
  - Spade or Shovel
  - Hand Saw or Power Saw
- 









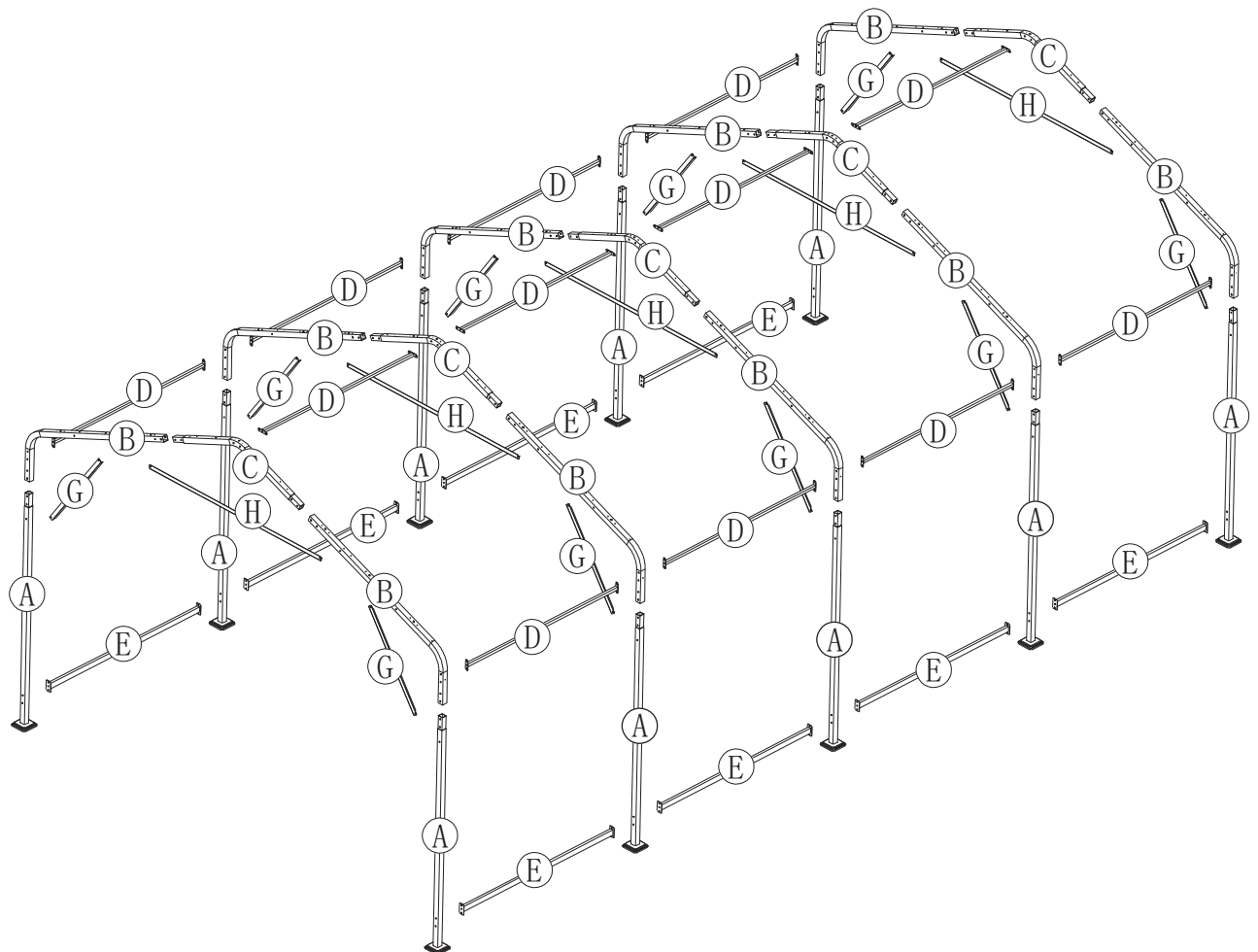
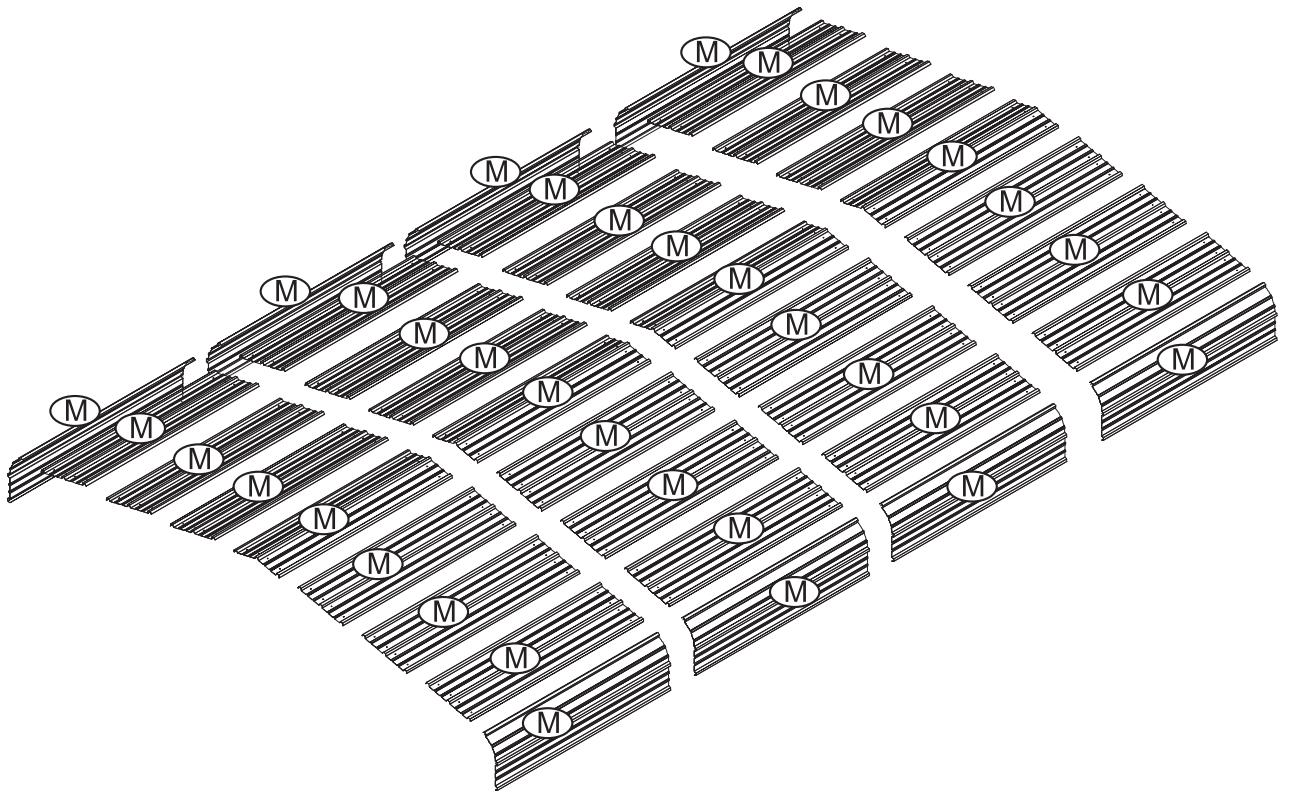









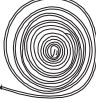
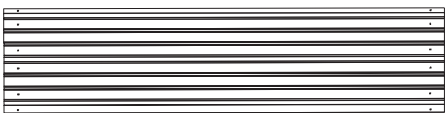

## Choosing and Preparing Your Site:

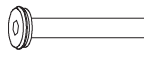
Select an ideal spot for your building before assembly begins. Opt for a level area with effective drainage.



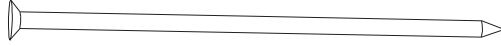

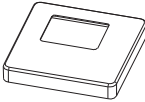
Ensure ample space around the construction area for easy movement and assembly of parts. Check that there's sufficient clearance at the entrance for doors to open fully. Additionally, you'll need enough external space around the building for attaching panel screws from the outside.

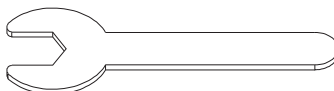
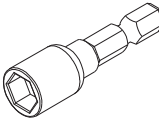
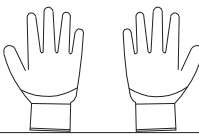
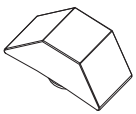
Prior to starting the assembly of any parts, make sure your base is in place and the anchoring system is set up and ready for action.



 A x10	 B x10
 C x5	 D x12
 E x8	 G x10
 H x5	 I x10
 Jx190 +10	 K x3
 L x1	 M x36
 M6*15 N x20	 M6*45 O x120 +5
 Ø 3.5 P x2	 M6 Q x140 +5
 M6 R x120 +5	 S x20
 M6x62 T x20	 U x10
 V x1	 W x1
 X x2	 Y x4
 Z x45 +2	



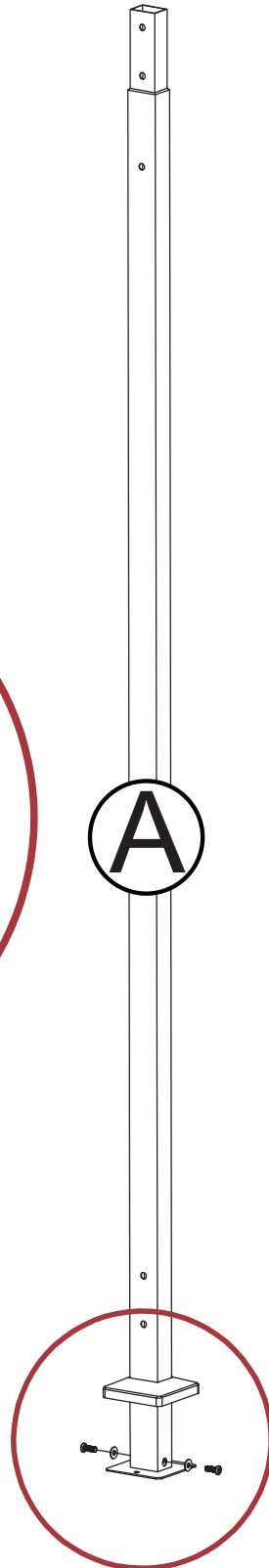
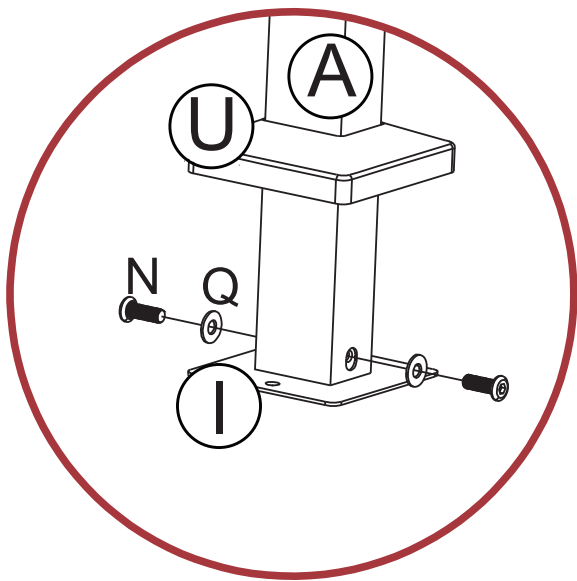

# STEP 1

	A	10
	I	10
	U	10
 M6*15	N	20
	Q	20

x10



# STEP 2

	C	5
	B	10
	O	20
	R	20
	Q	20

x5

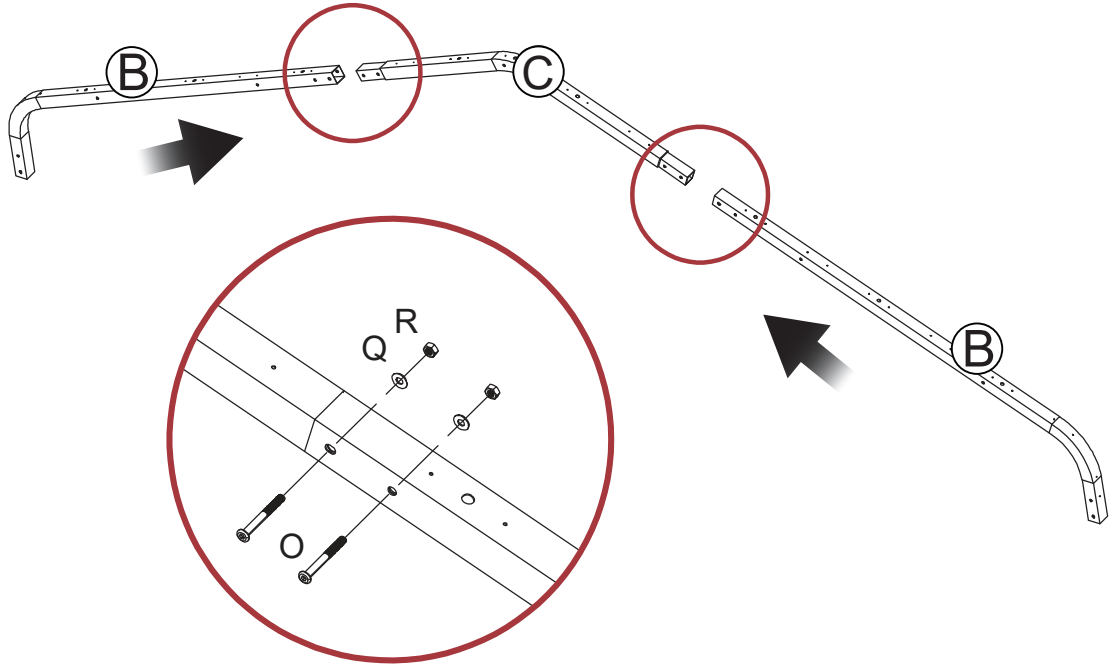



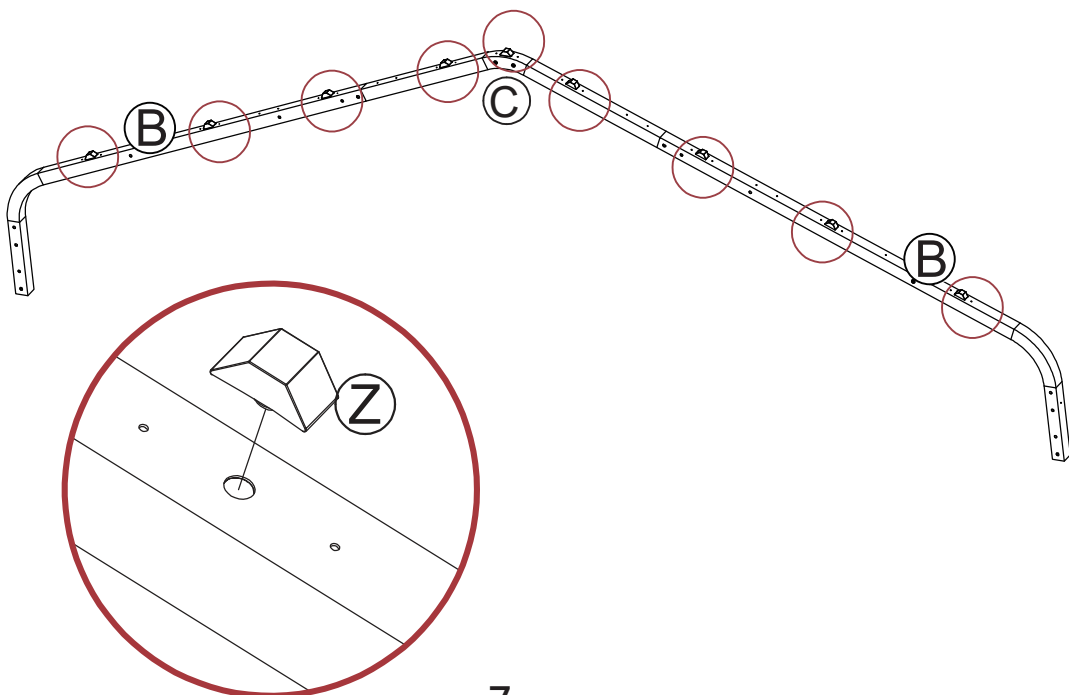

# STEP 3

	Z	45
---	---	----

x5





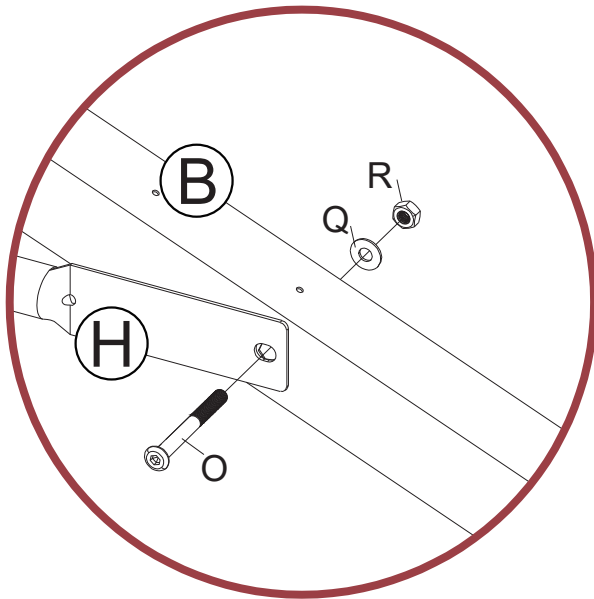
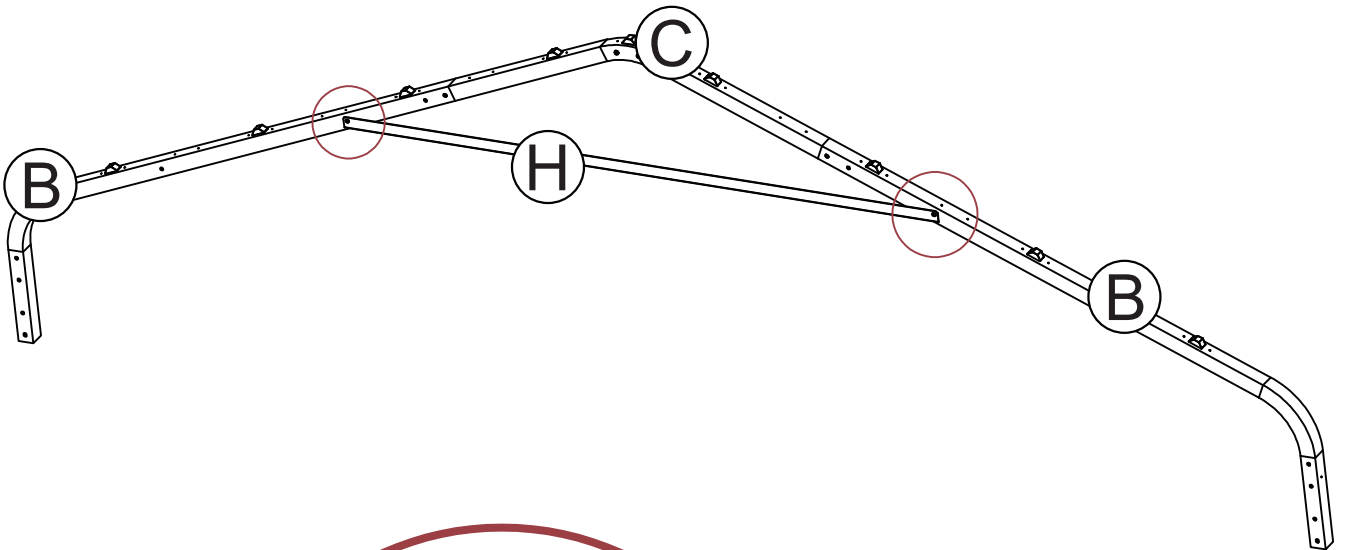

# STEP 4

	H	5
	O	10
	Q	10
	R	10

X5





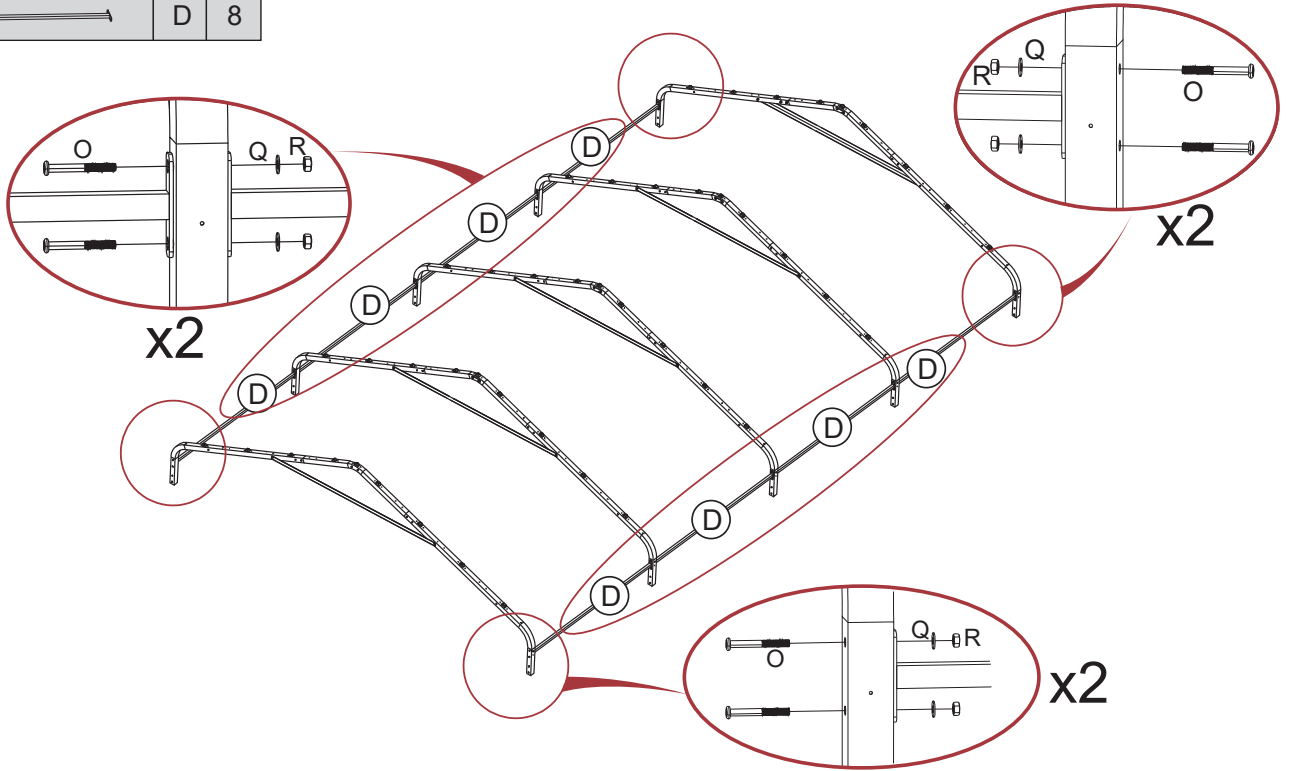

# STEP 5

	O	20
	Q	20
	R	20
	D	8



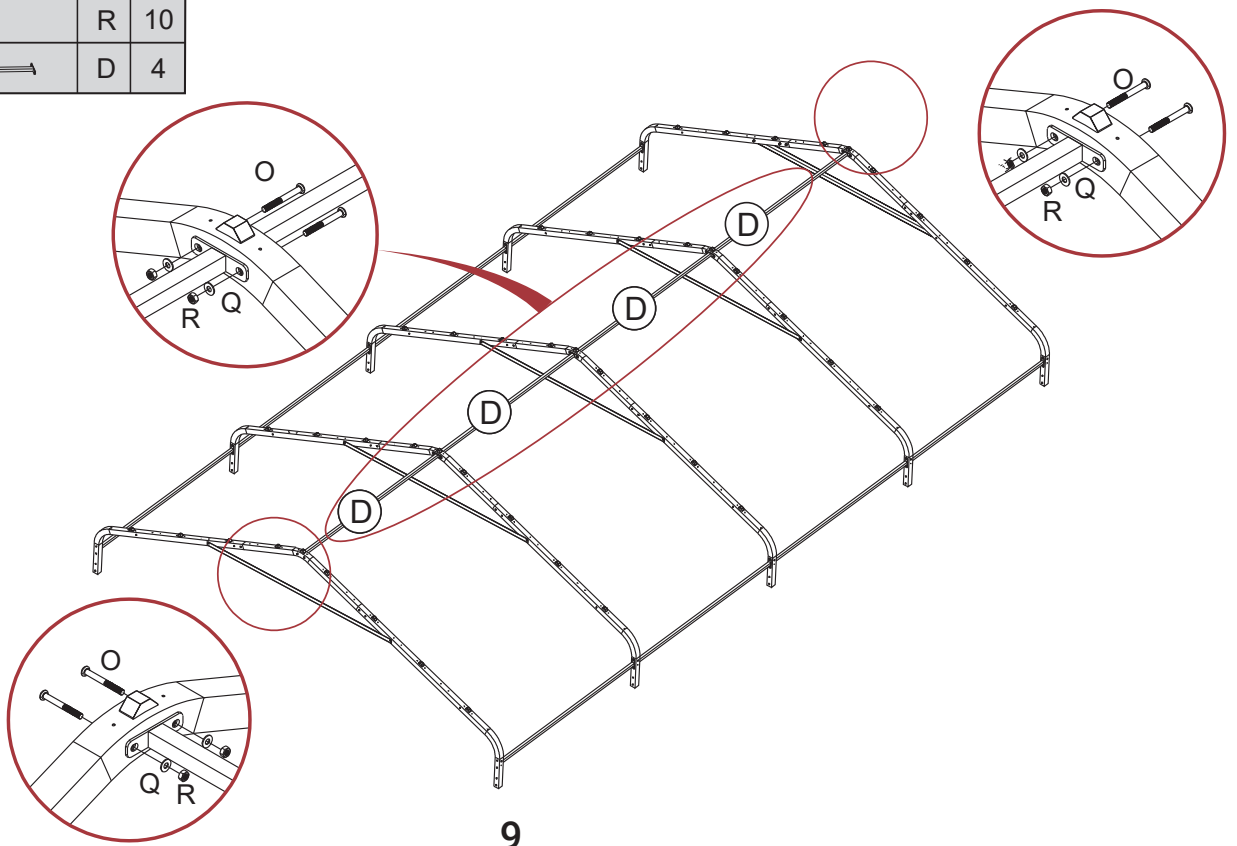

# STEP 6

	O	10
	Q	10
	R	10
	D	4





# STEP 7

	M	4
	J	10
	K	

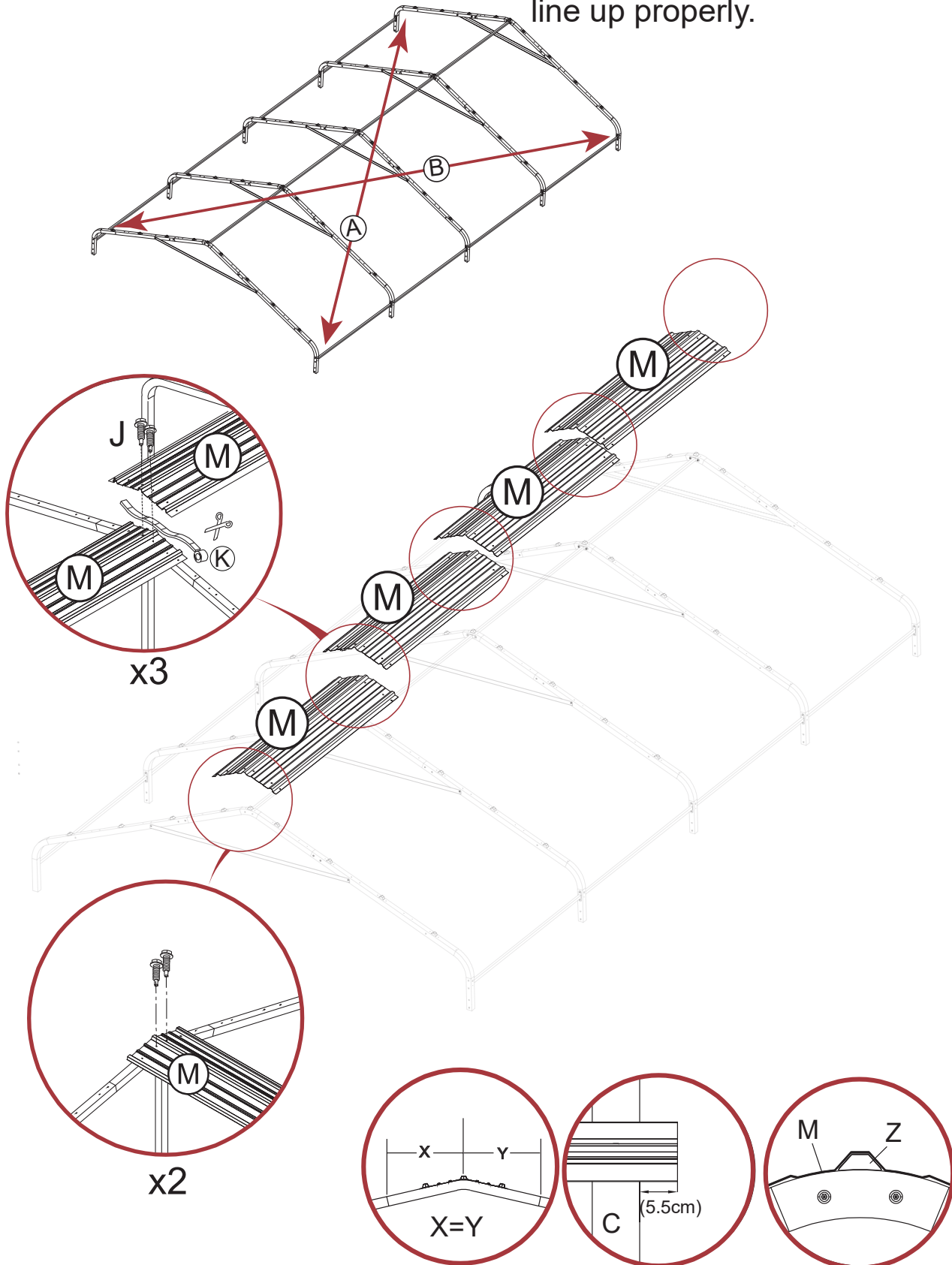
Check that A and B are equal in length for easy installation of M—the holes will line up properly.



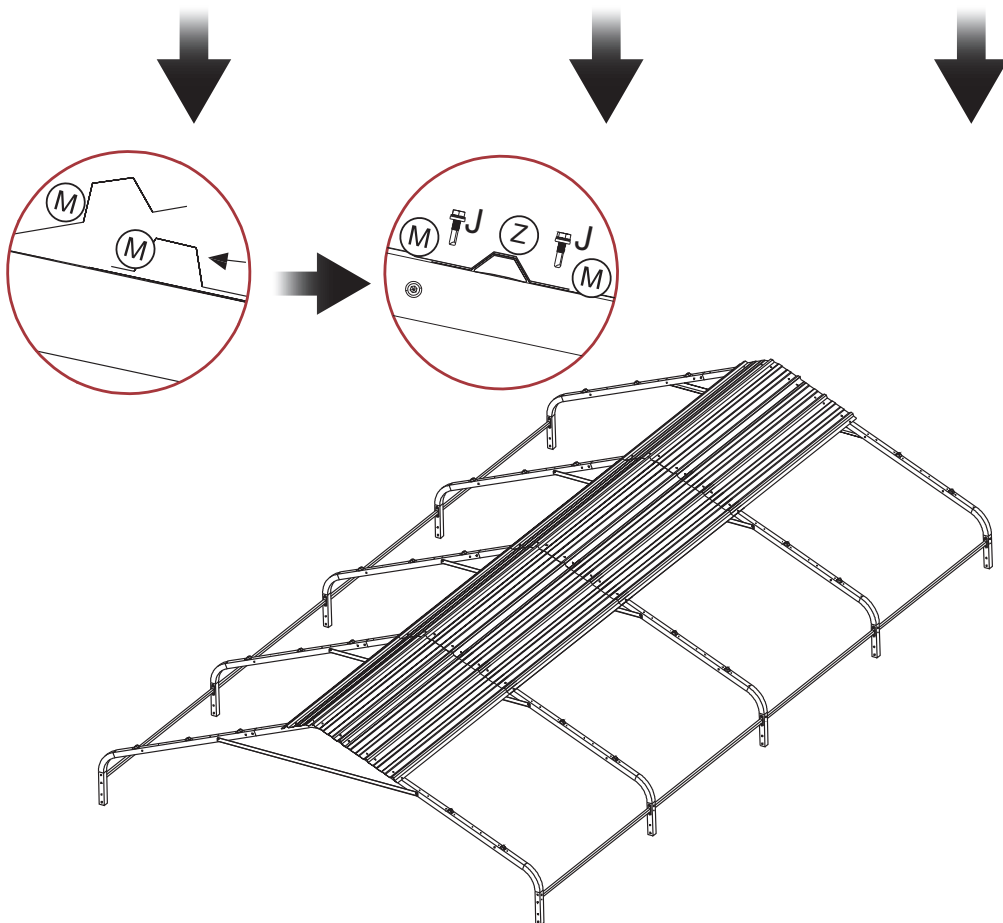
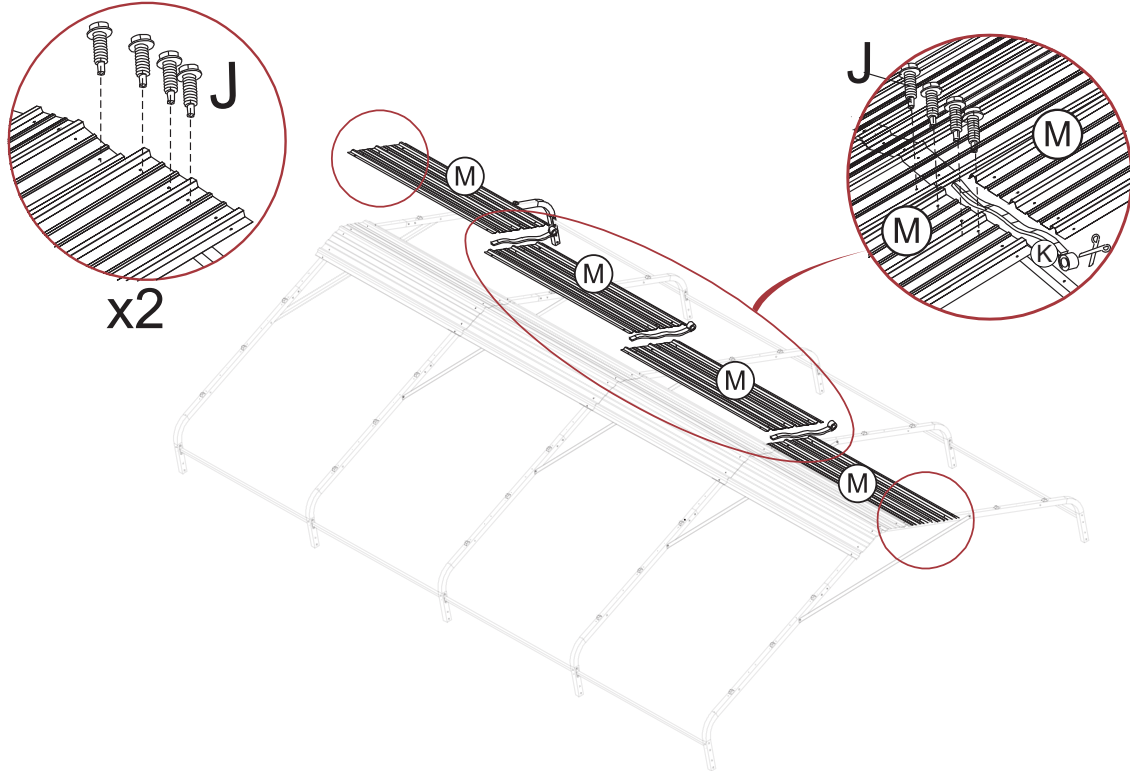

# STEP 8

	M	4
	J	20
	K	



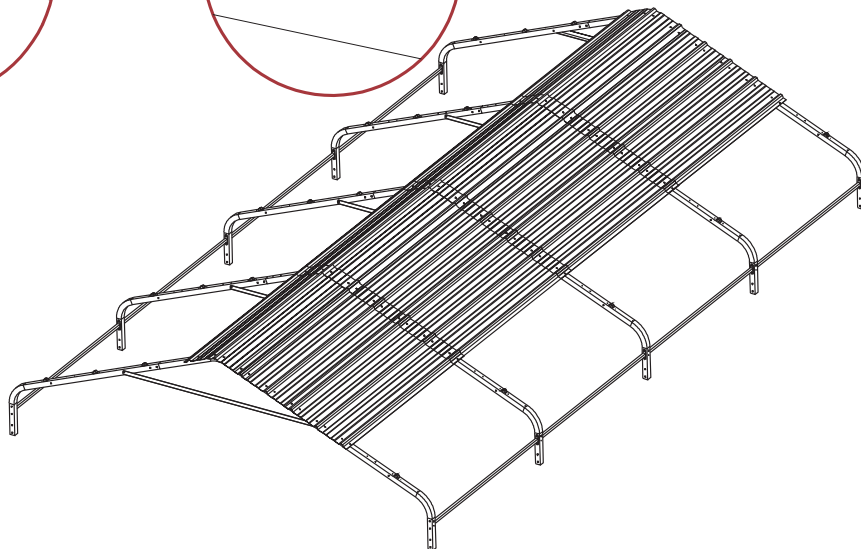
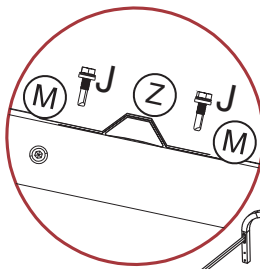
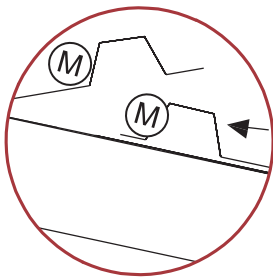
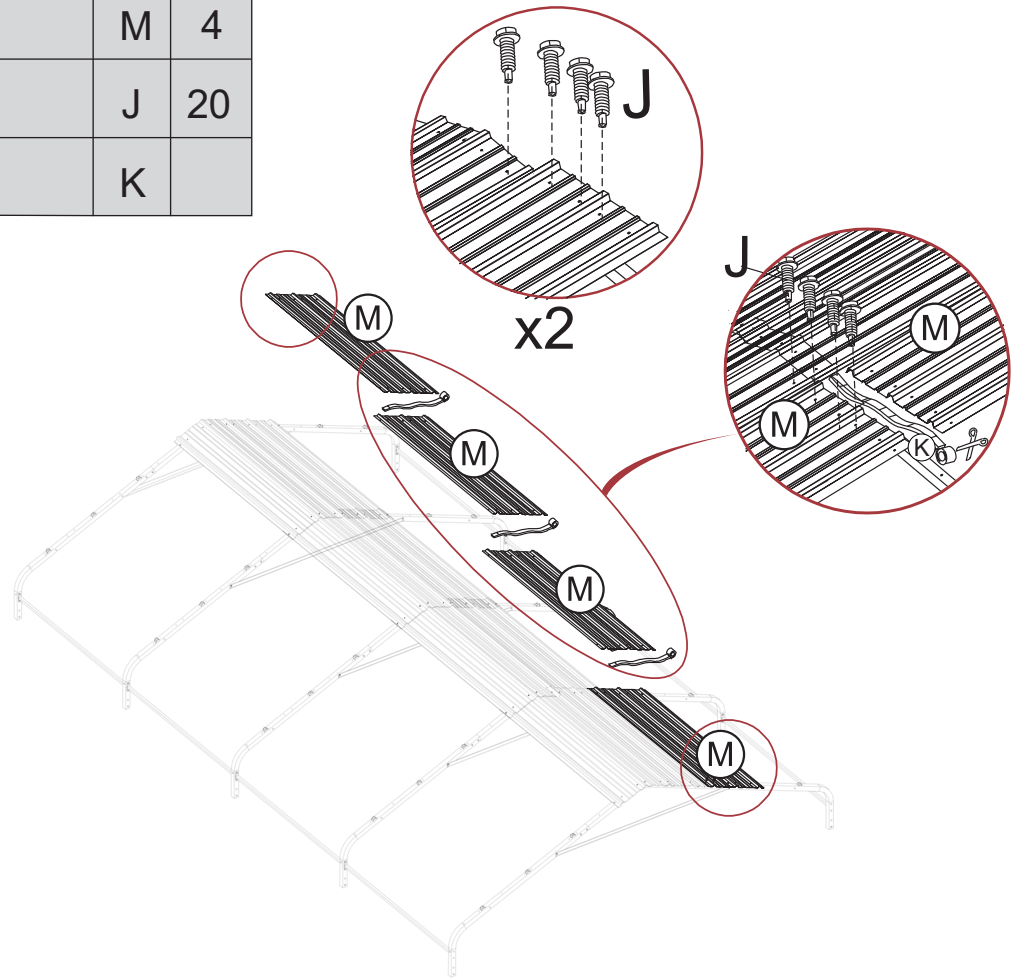

# STEP 9

	M	4
	J	20
	K	



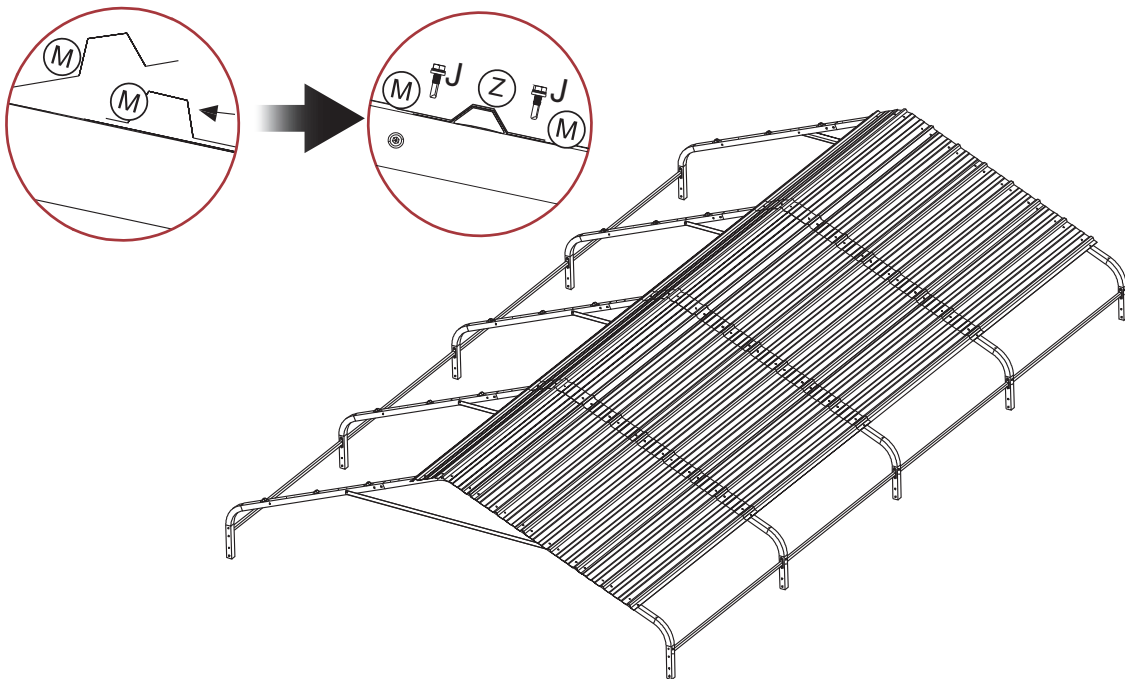
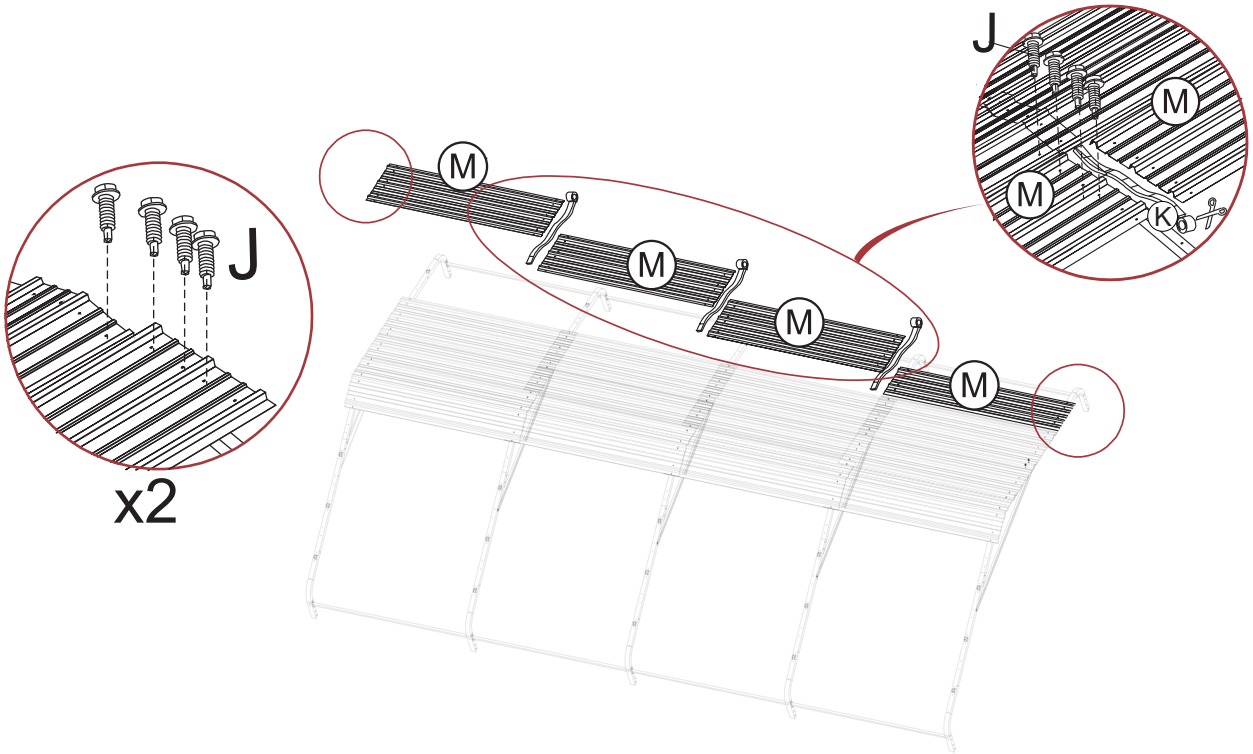

# STEP 10

	M	4
	J	20
	K	



# STEP 11

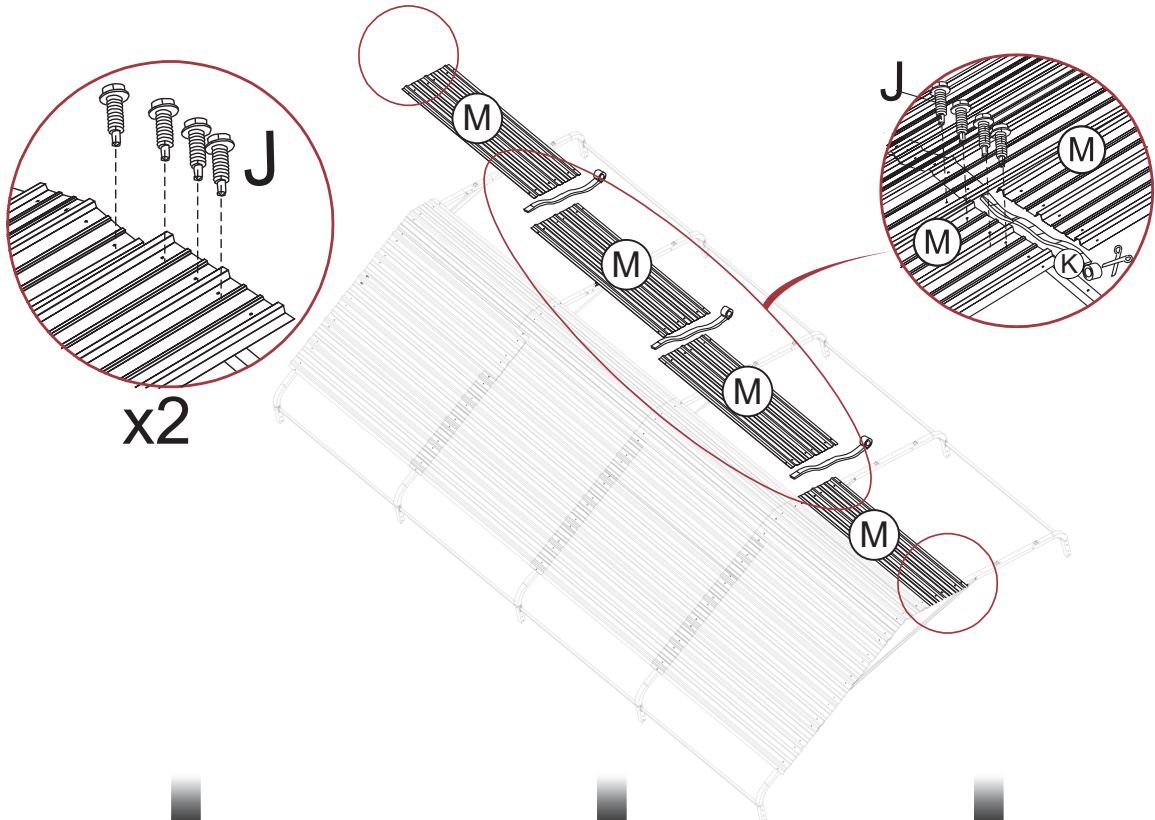

	M	4
	J	20
	K	

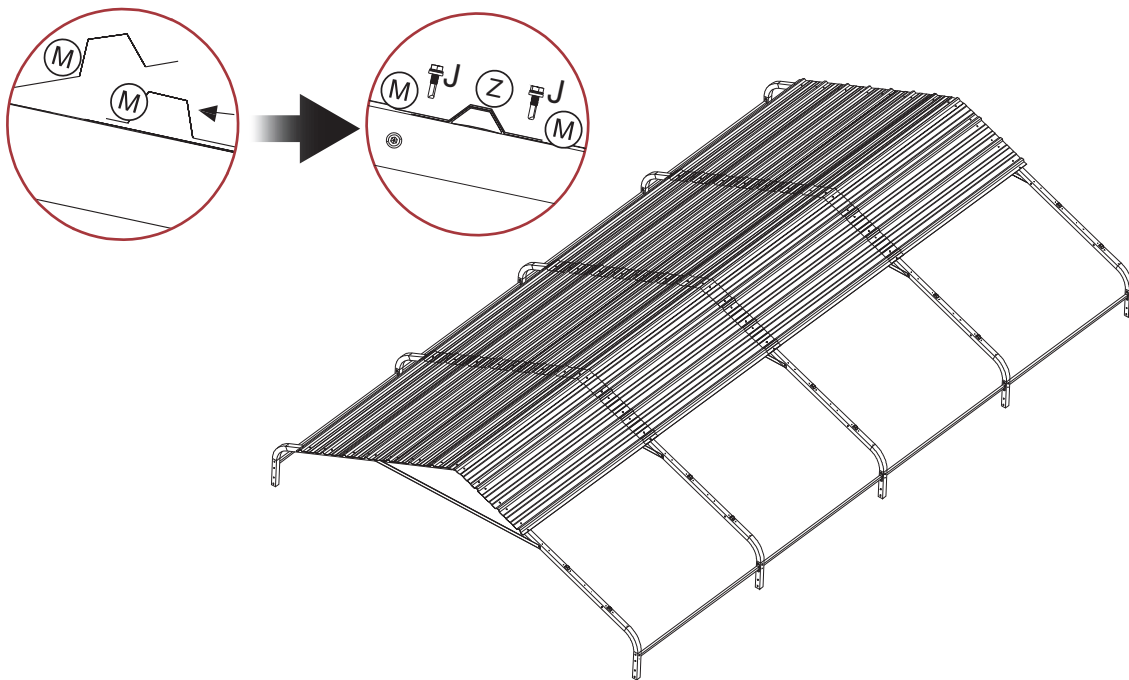

x2



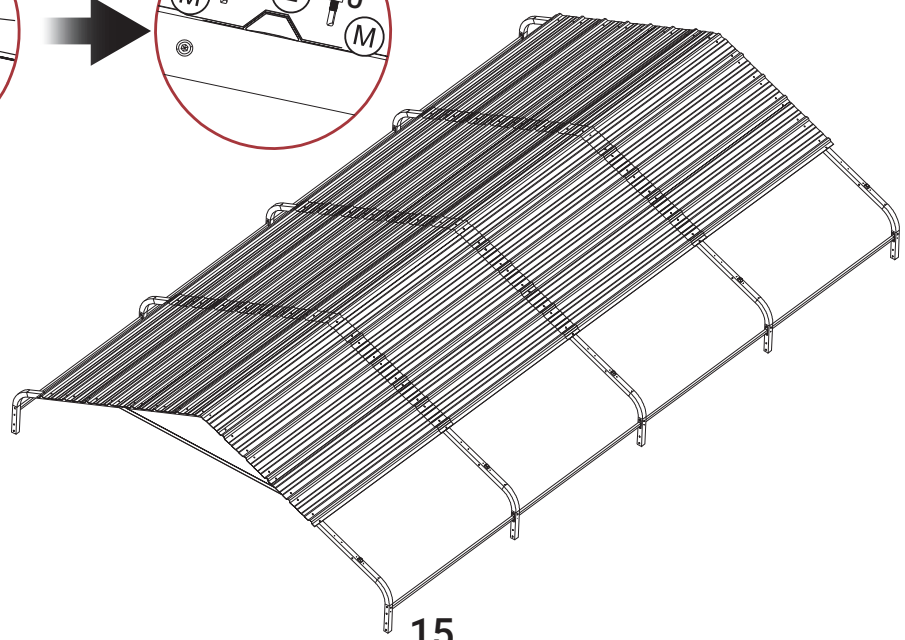
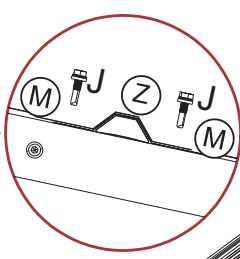
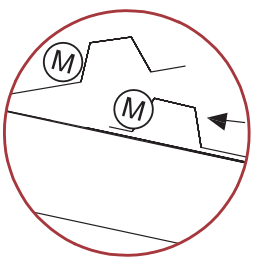
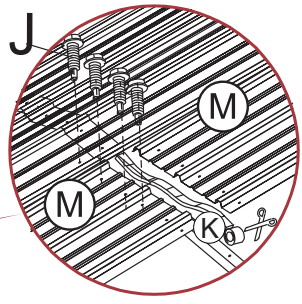
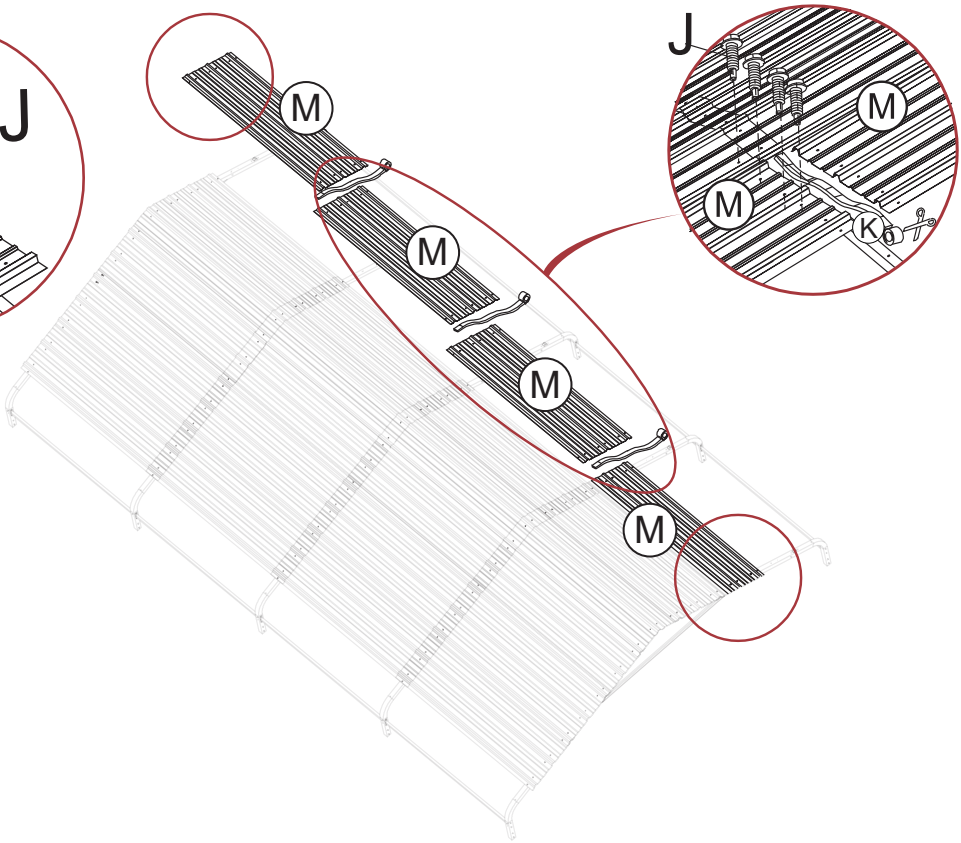
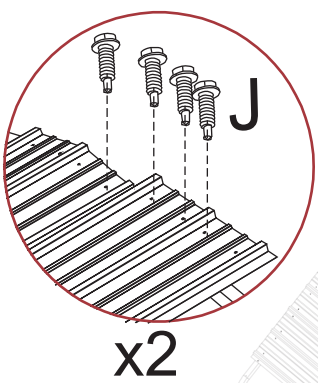

# STEP 12

	M	4
	J	20
	K	



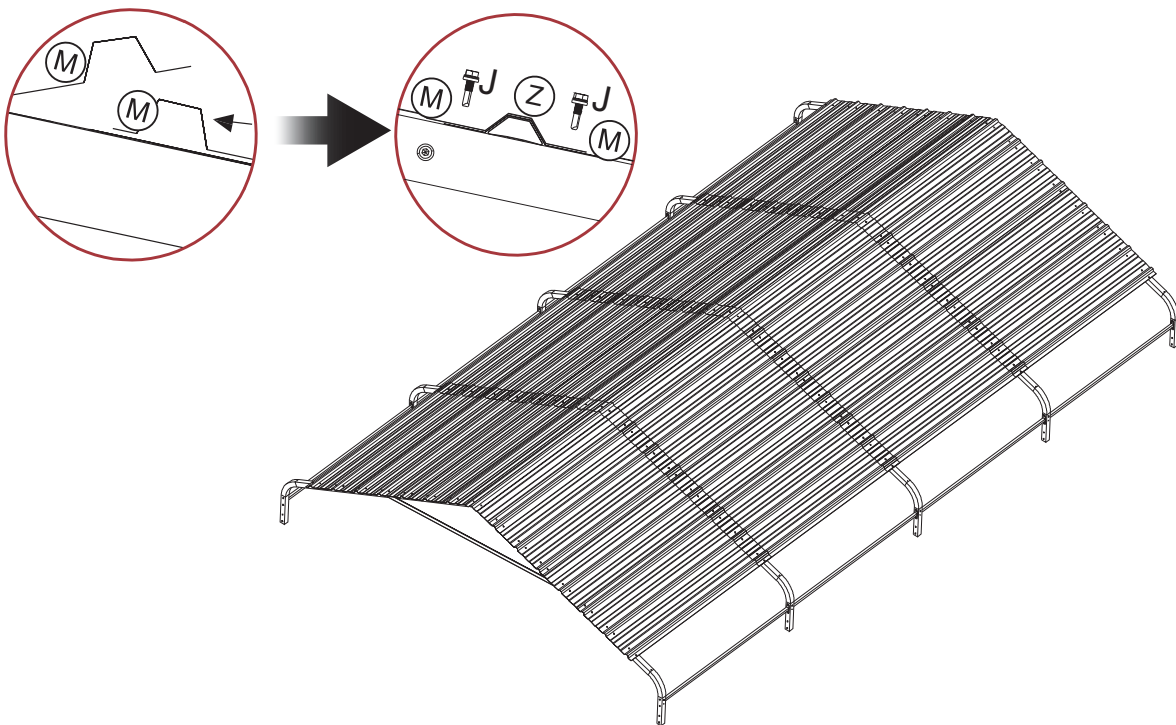
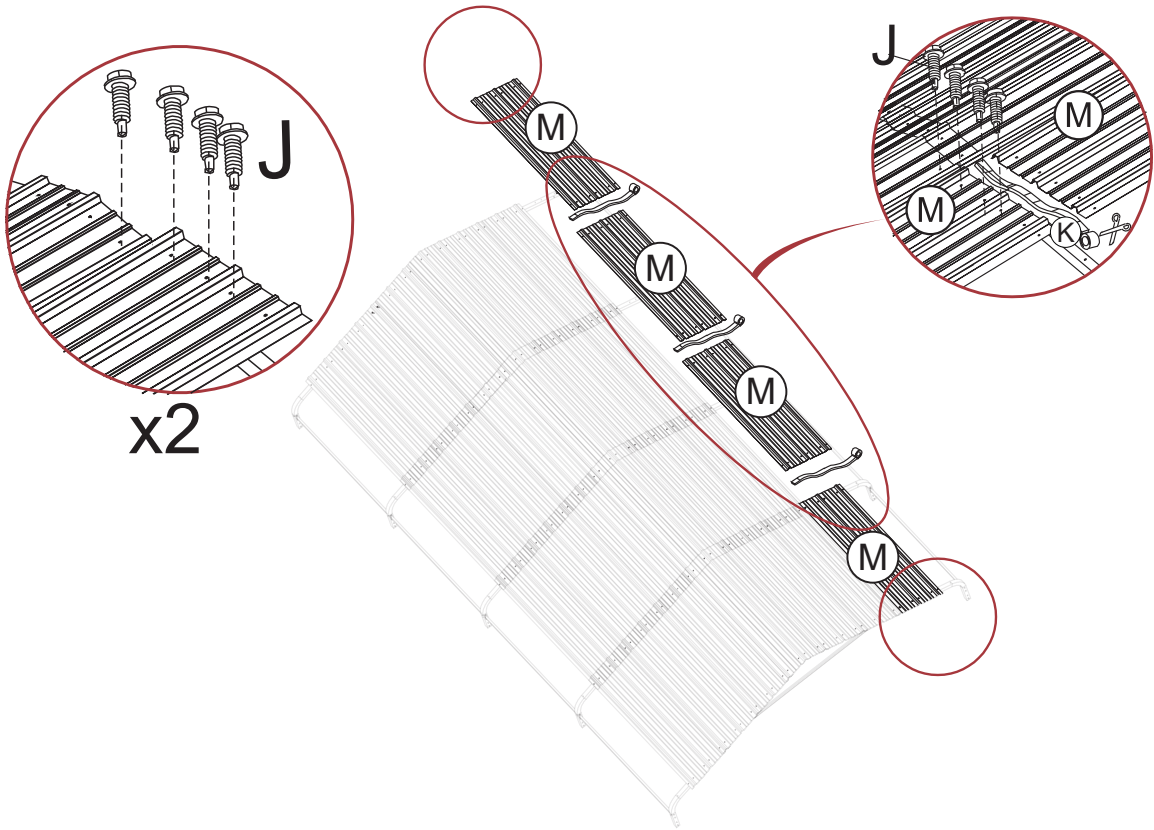

# STEP 13

	M	4
	J	20
	K	



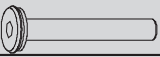

# STEP 14

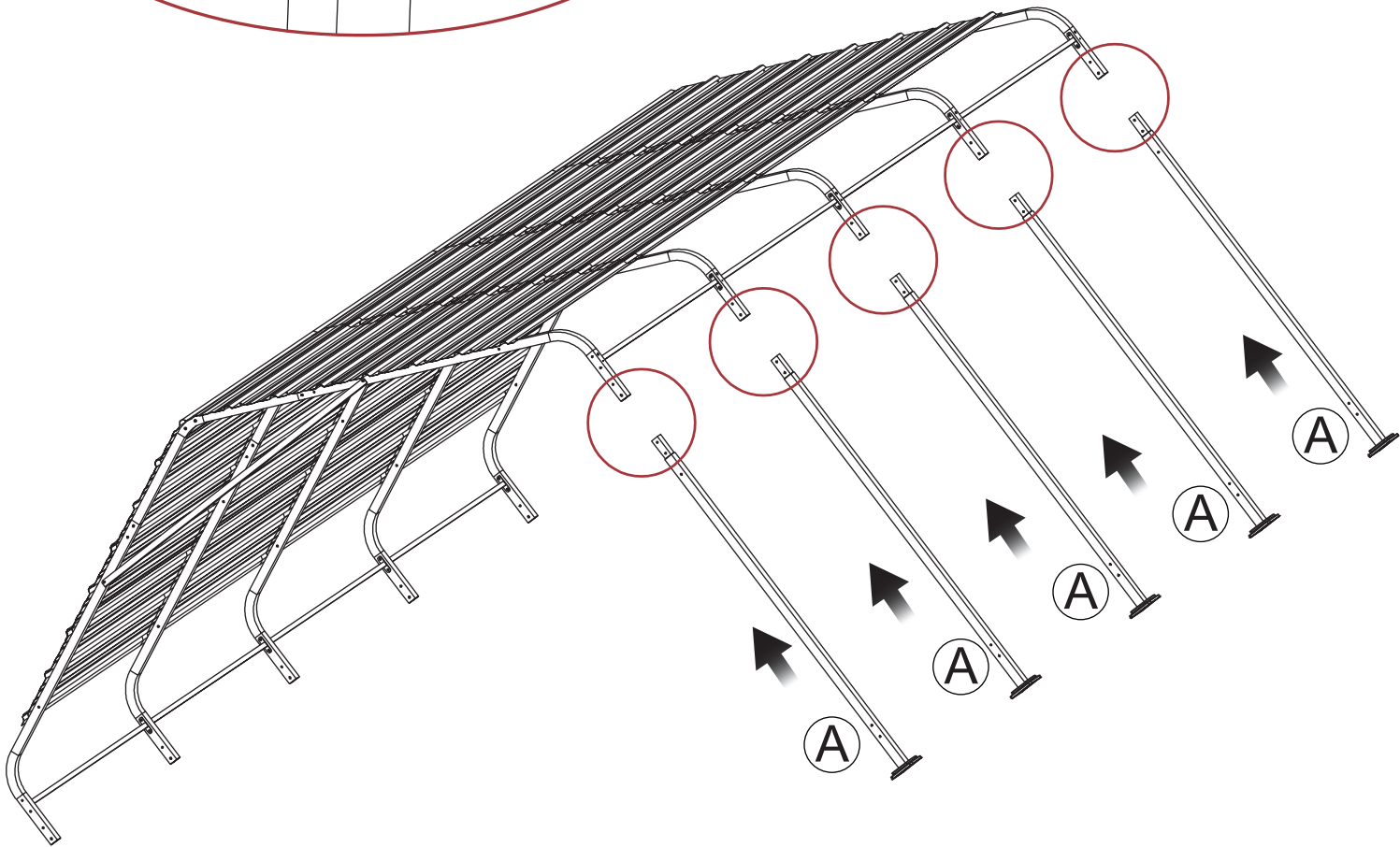
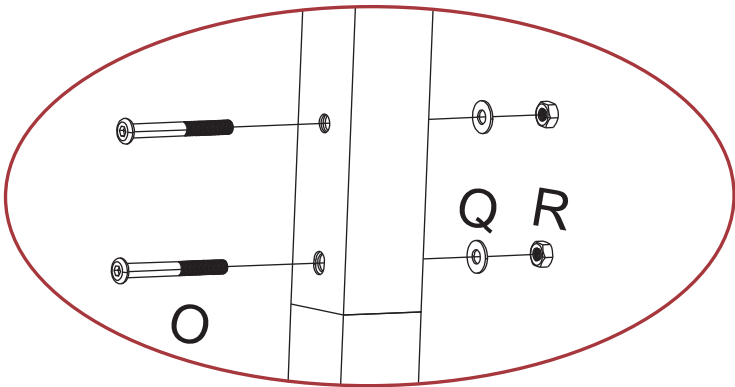
	O	10
	Q	10
	R	10



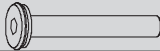

# STEP 15

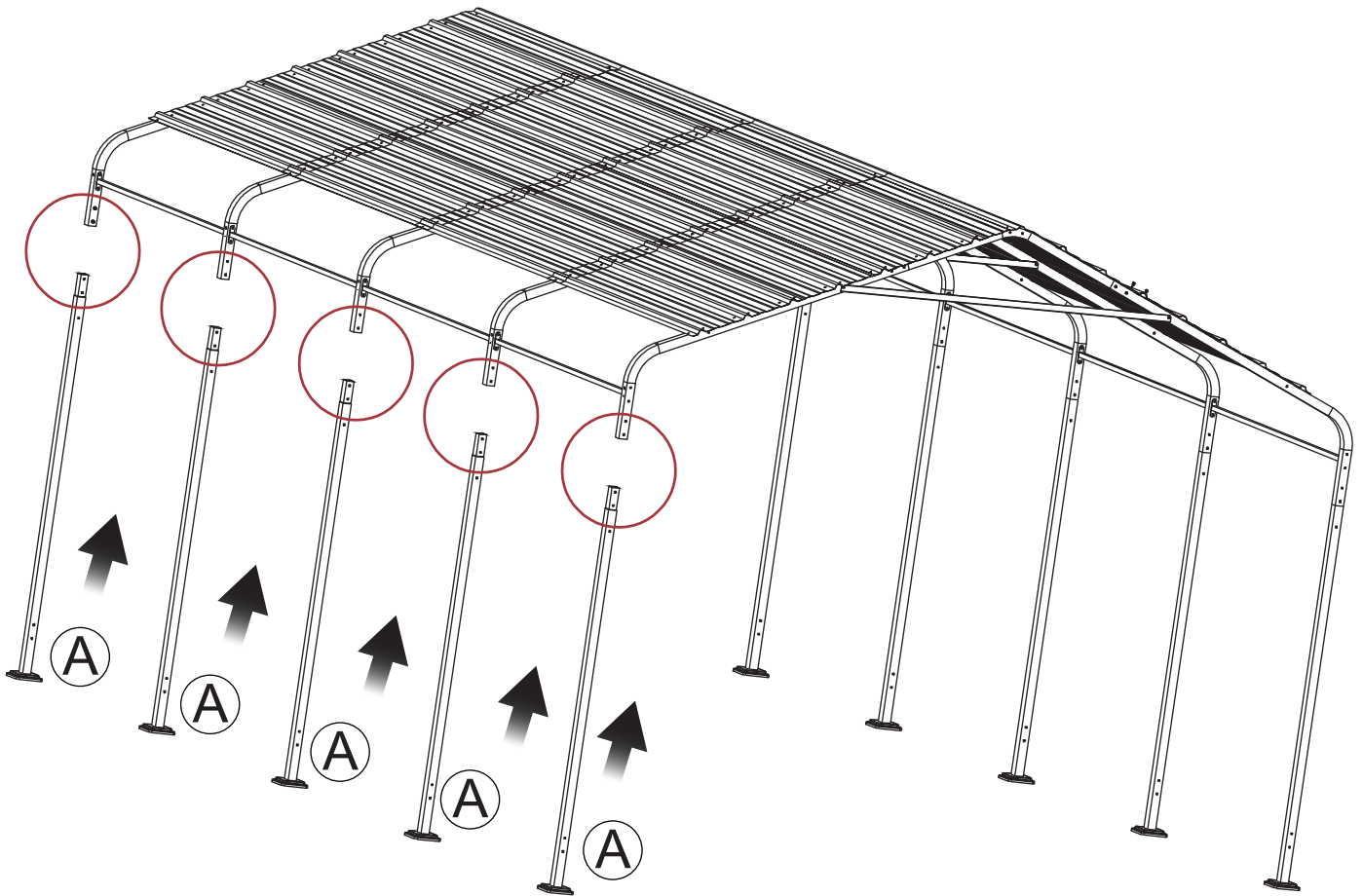
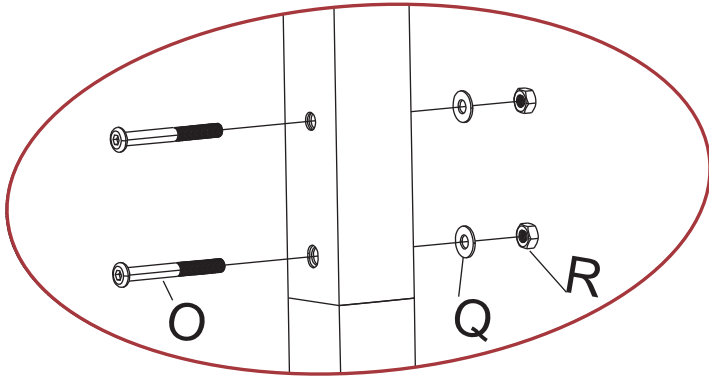
	O	10
	Q	10
	R	10



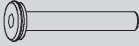

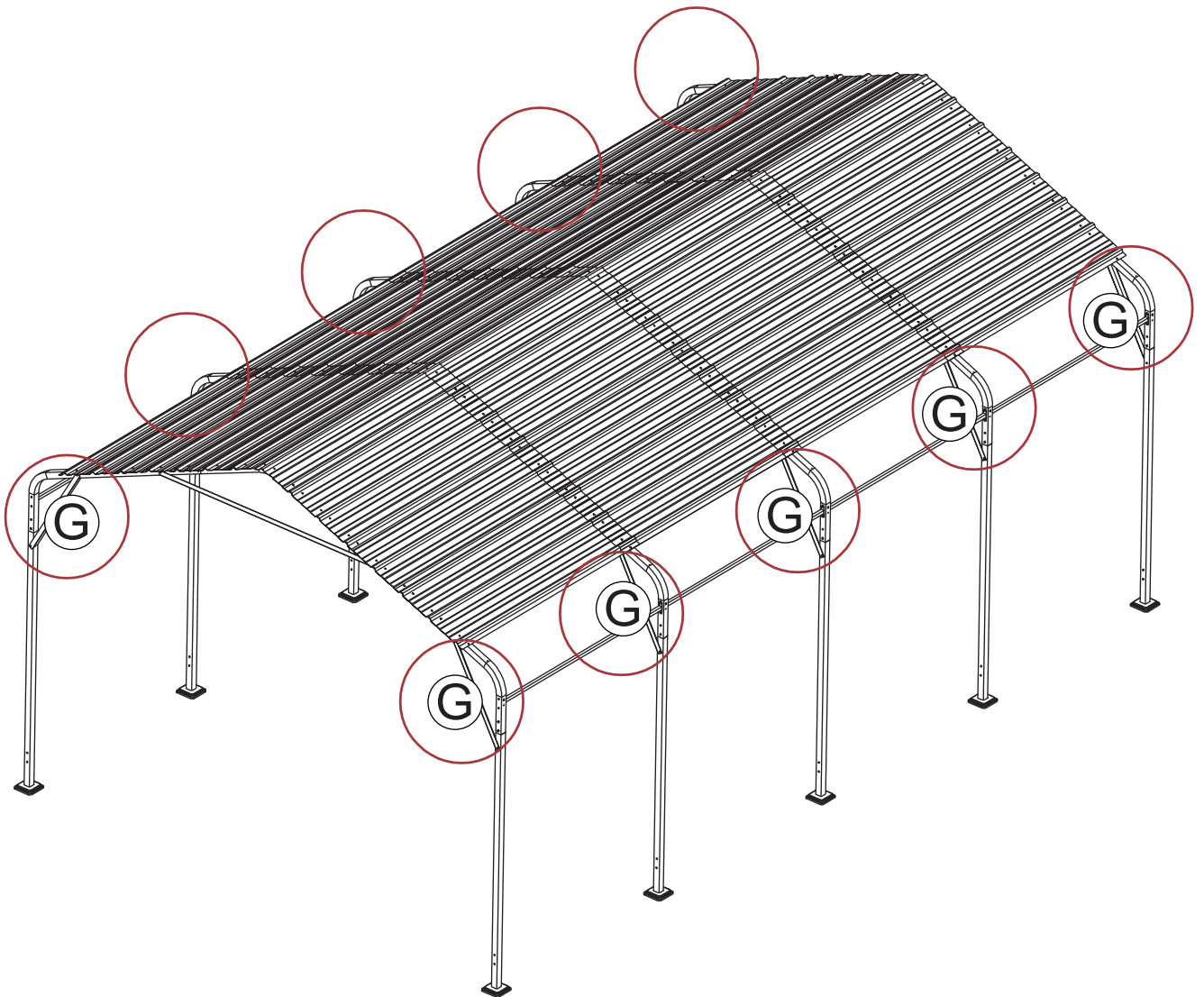
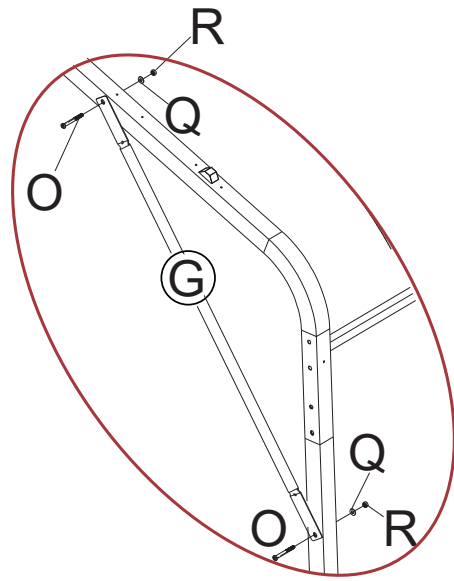

# STEP 16

	G	10
	O	20
	Q	20
	R	20



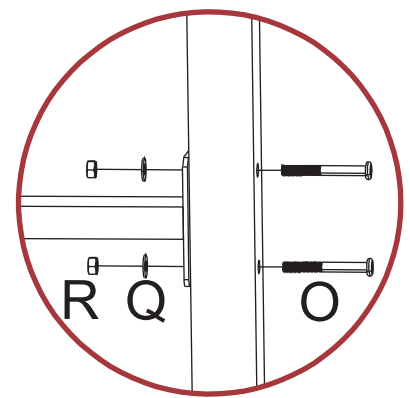
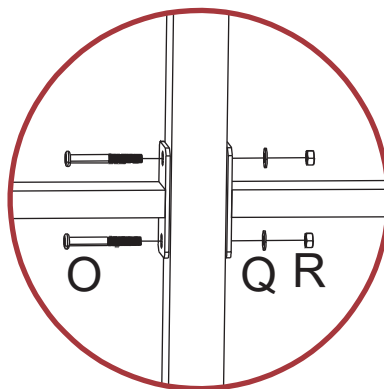
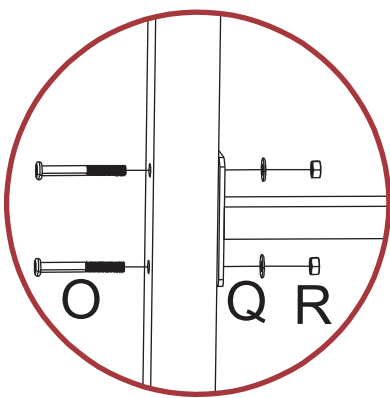
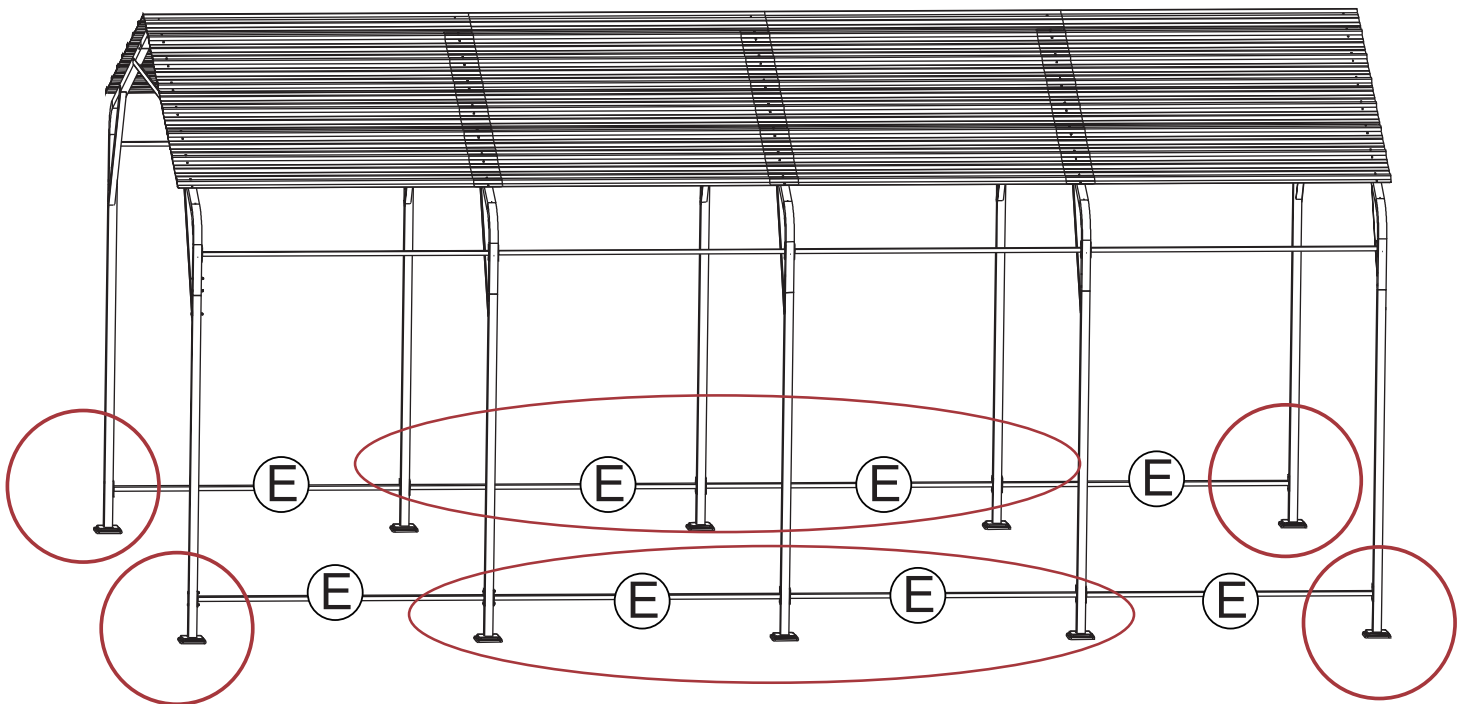

# STEP 17

	E	8
	O	20
	Q	20
	R	20



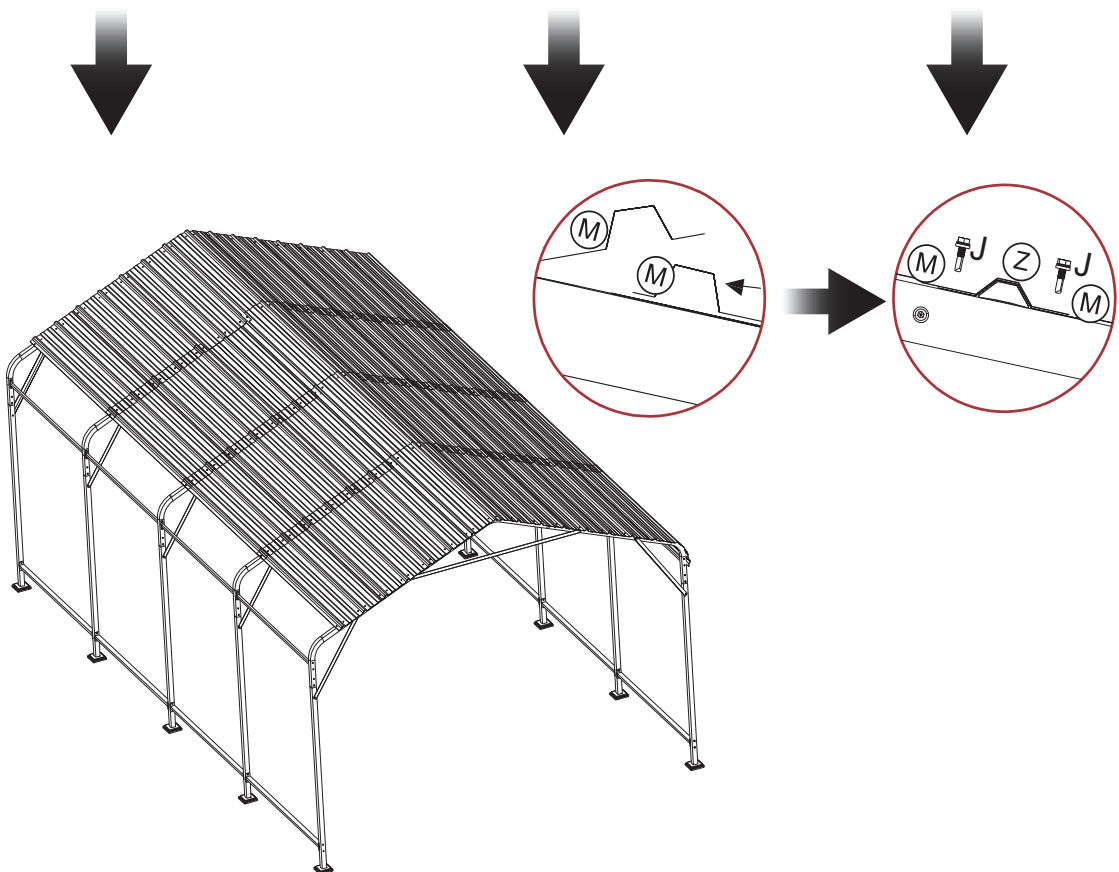
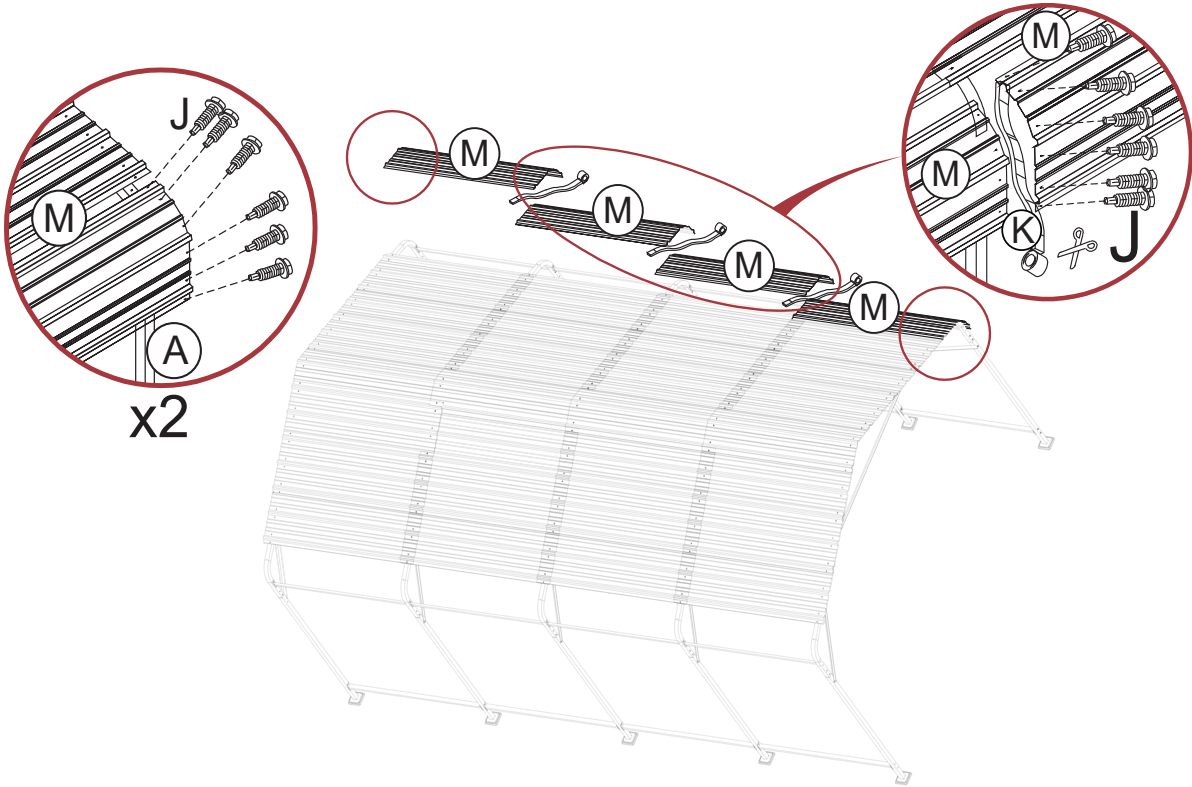

# STEP 18

	M	4
	J	30
	K	



# STEP 19

	M	4
	J	30
	K	

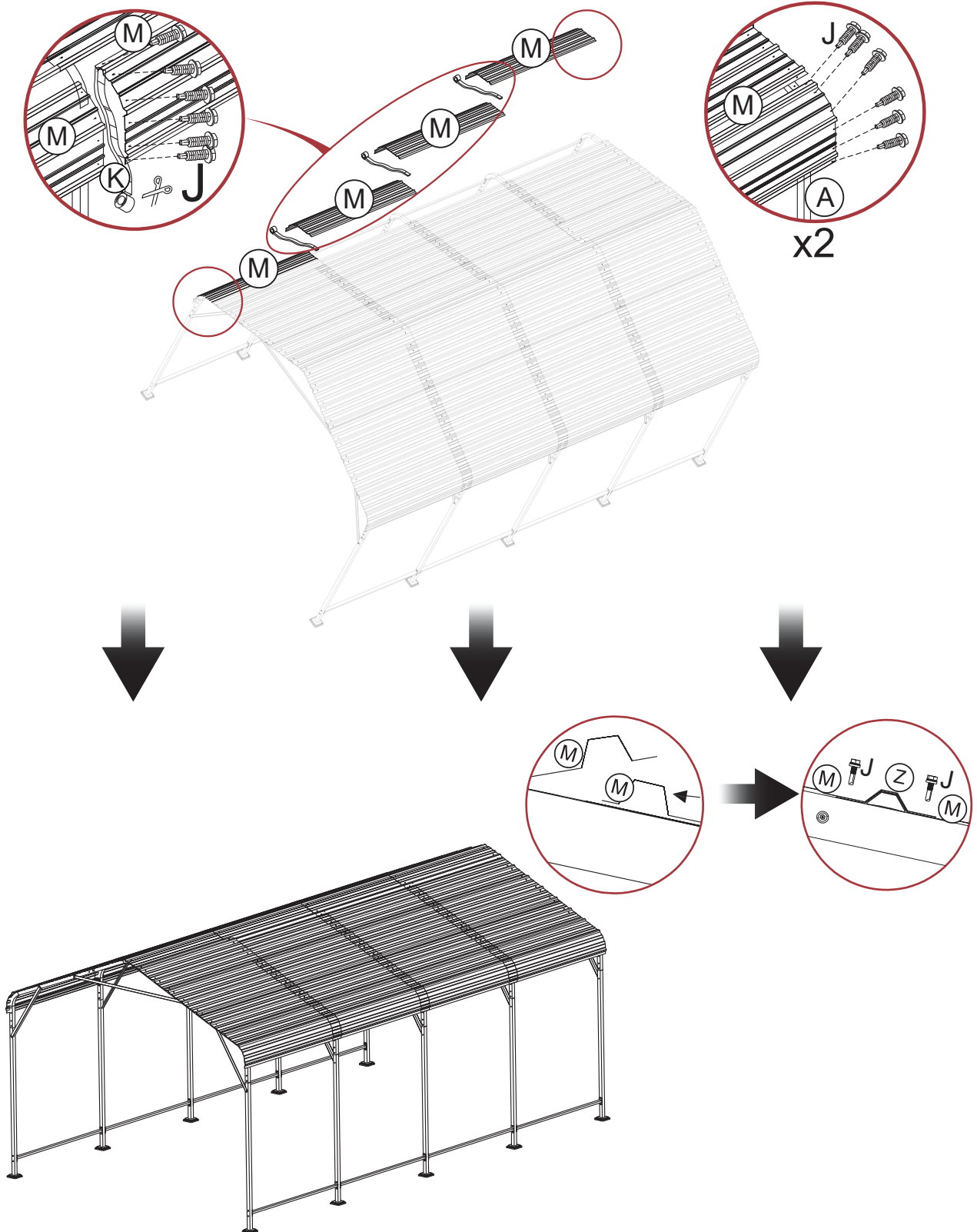

# STEP 20

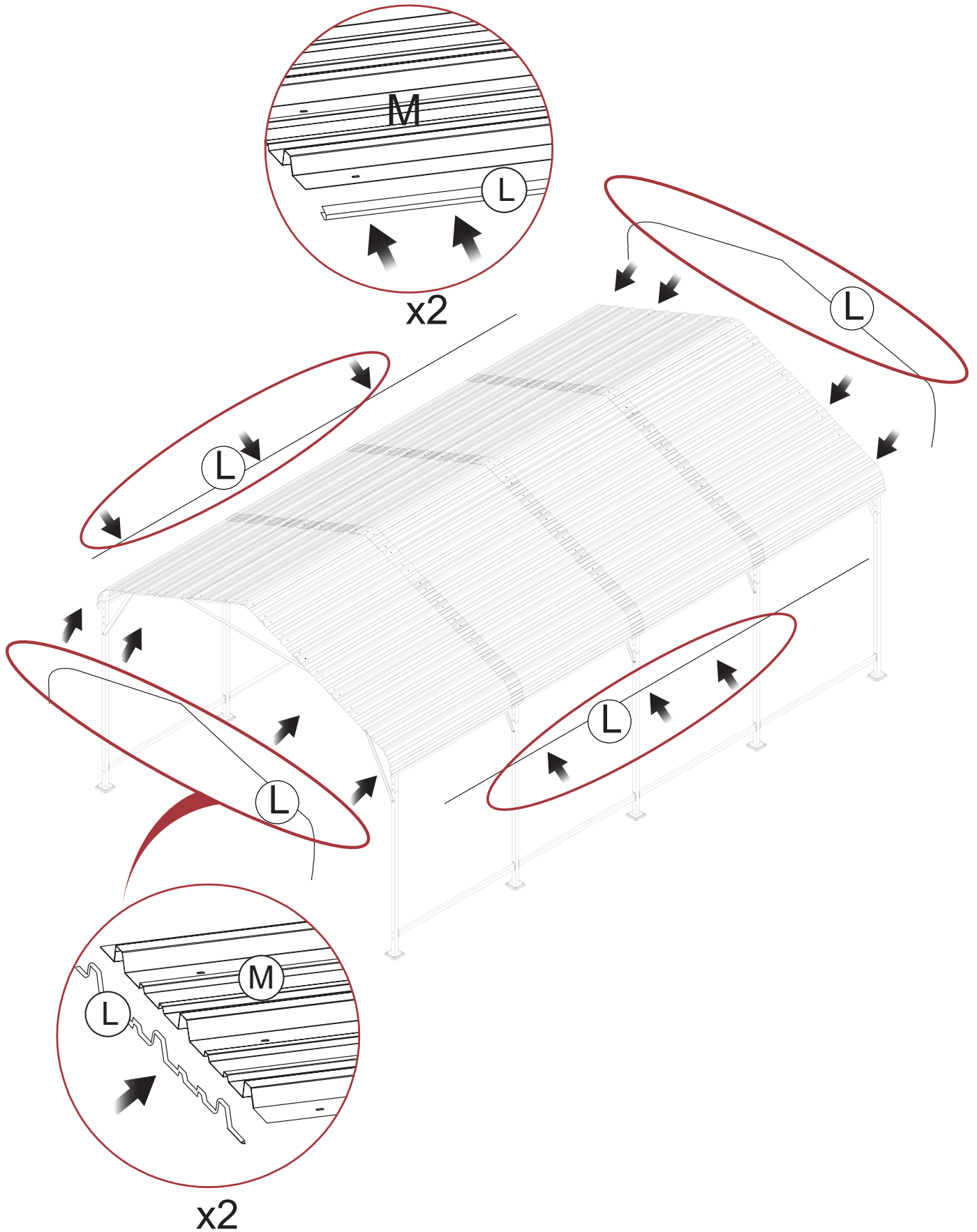
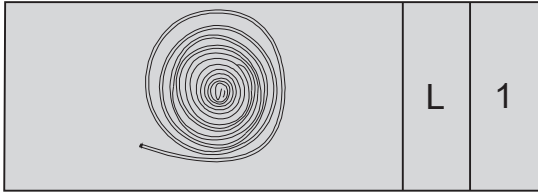

# STEP 21

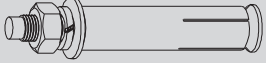
	s	20
	T	20

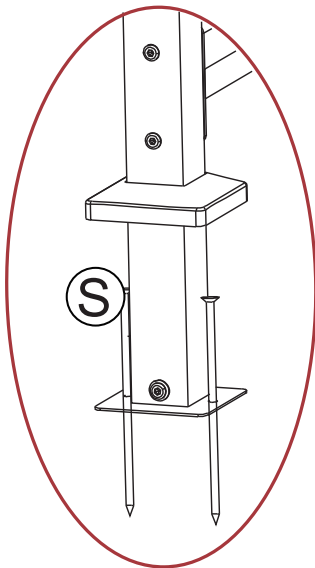
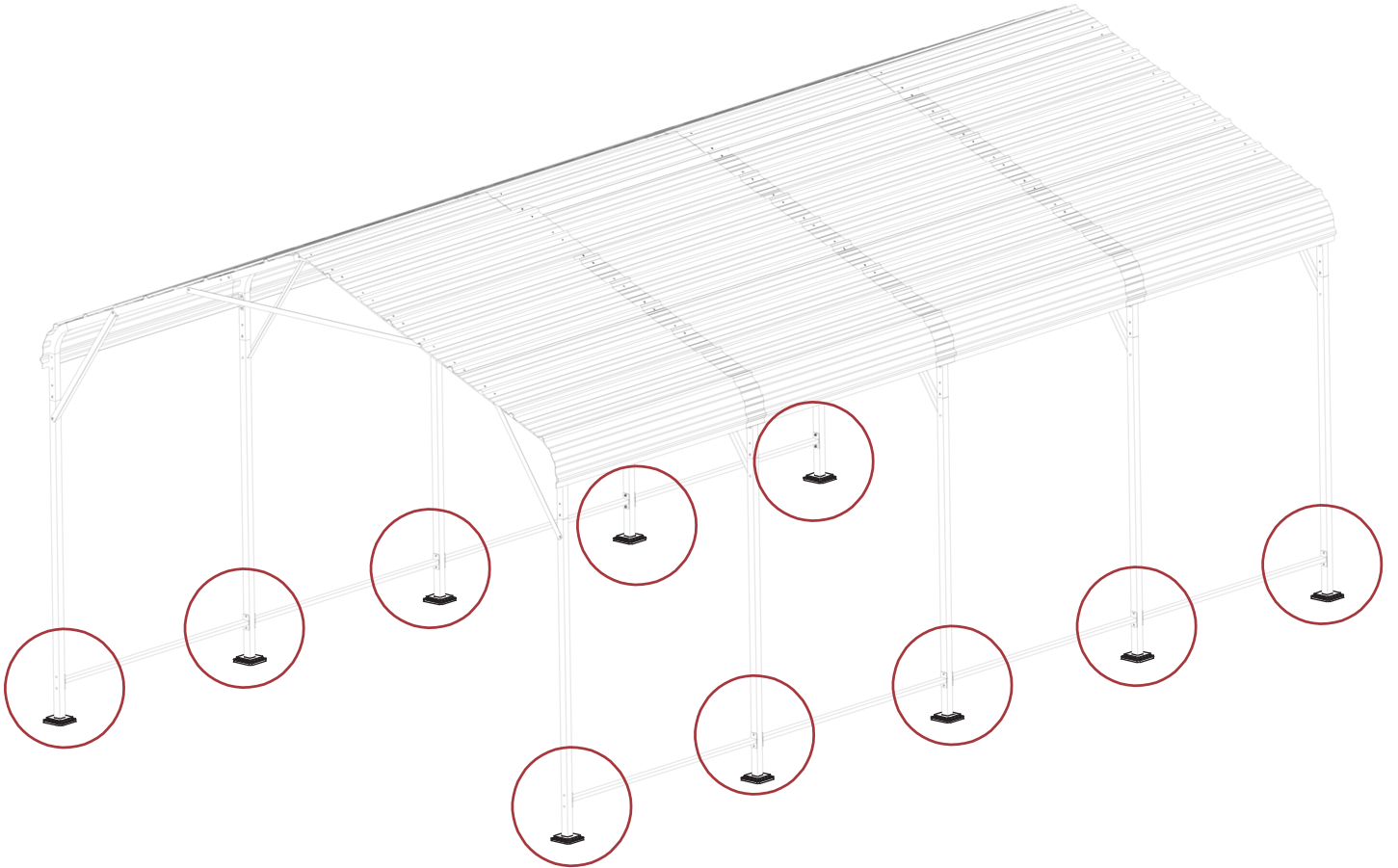

or

