

# L Shaped Desk

## Instruction Manual

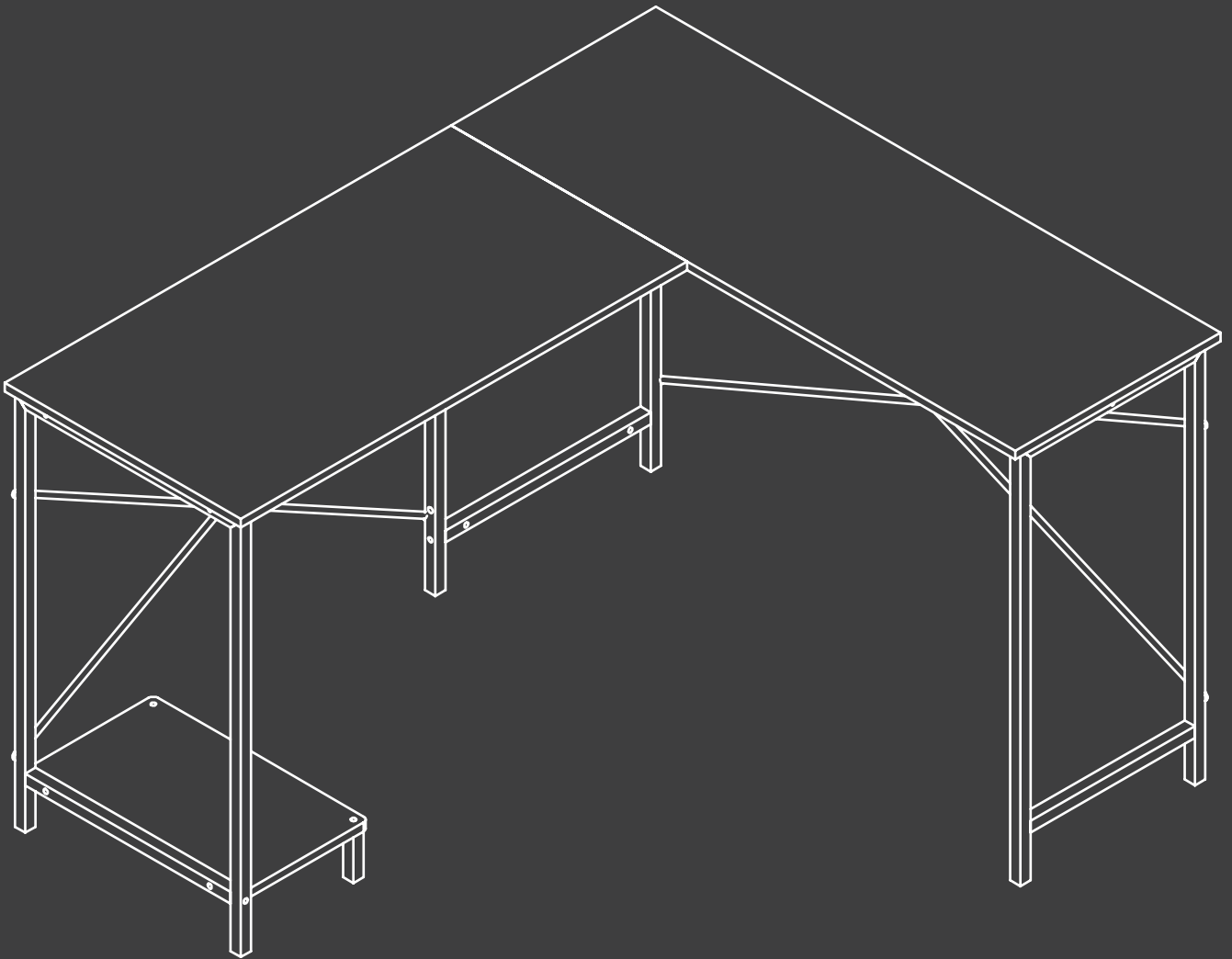

# 1 Components List

---

**A** X1

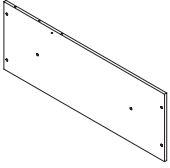

**B** X1

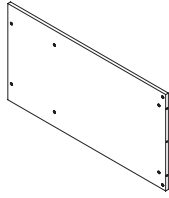

**C** X1

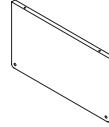

**D** X1

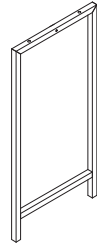

**E** X1

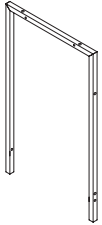

**F** X1

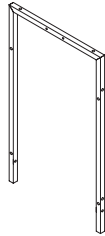

**G** X2

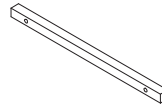

**H** X1

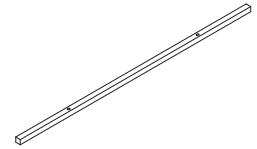

**I** X1

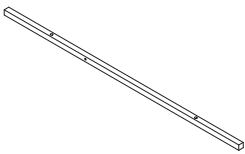

**J** X2

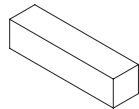

**K** X1



**L** X1



connect Legs **E**&**F**

connect Legs **D**&**F**

## 2 Supplied Parts and Hardware

---

1 X20



M6\*28mm

2 X8



M6\*12mm

3 X2

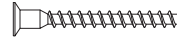

M6\*50mm

4 X3

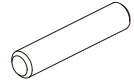

Φ6\*40mm

5 X3



Φ12mm

6 X1



M4

---

### ATTENTION:

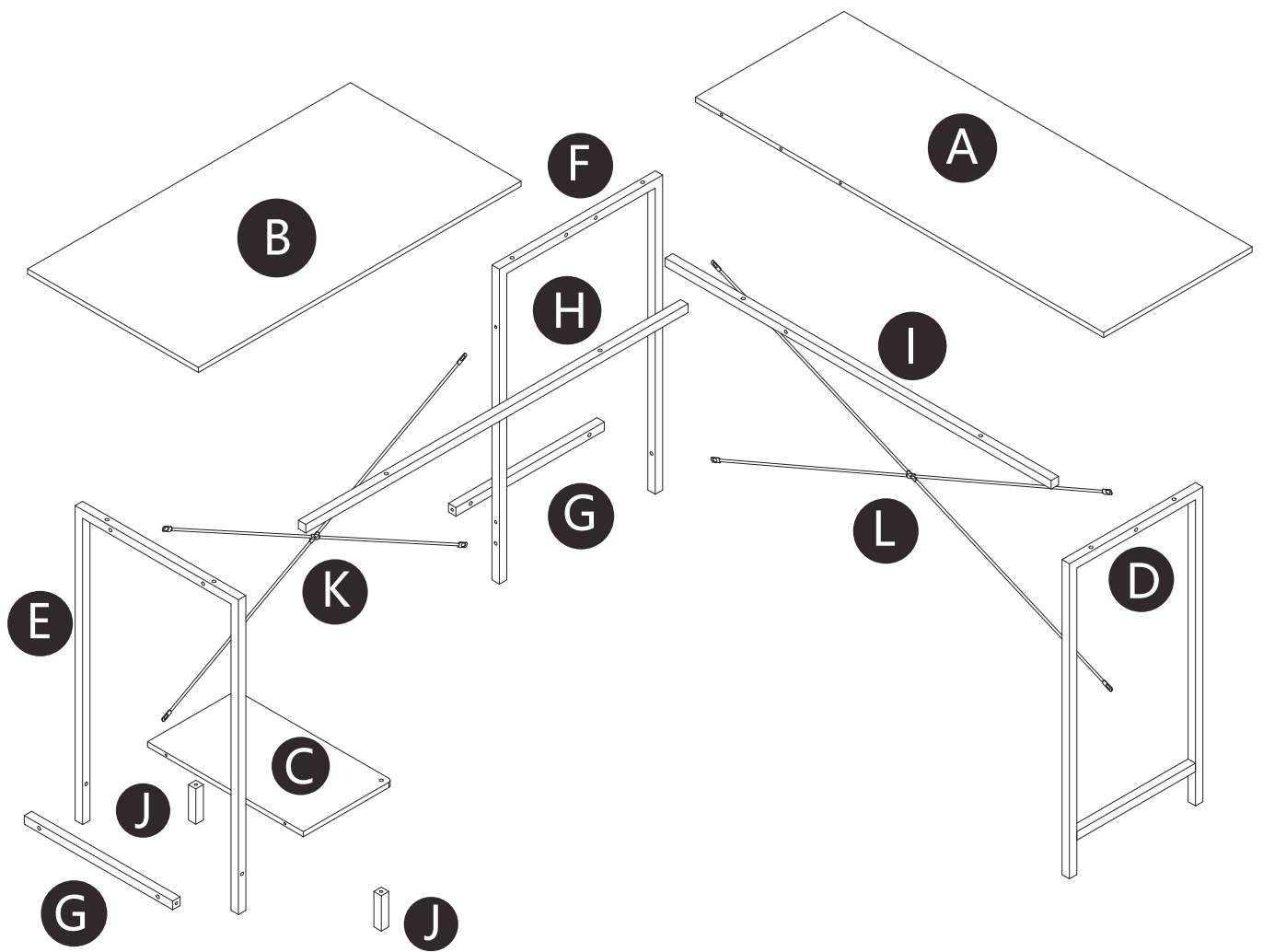

1. Please do not use corrosive liquids to clean the desk.
2. Please store parts out of children's reach to prevent the risk of swallowing.
3. Please do not place overheated kitchenware and tableware to avoid damaging the desk.

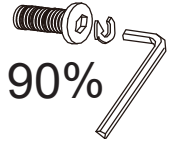

# Option 1

## Step 1



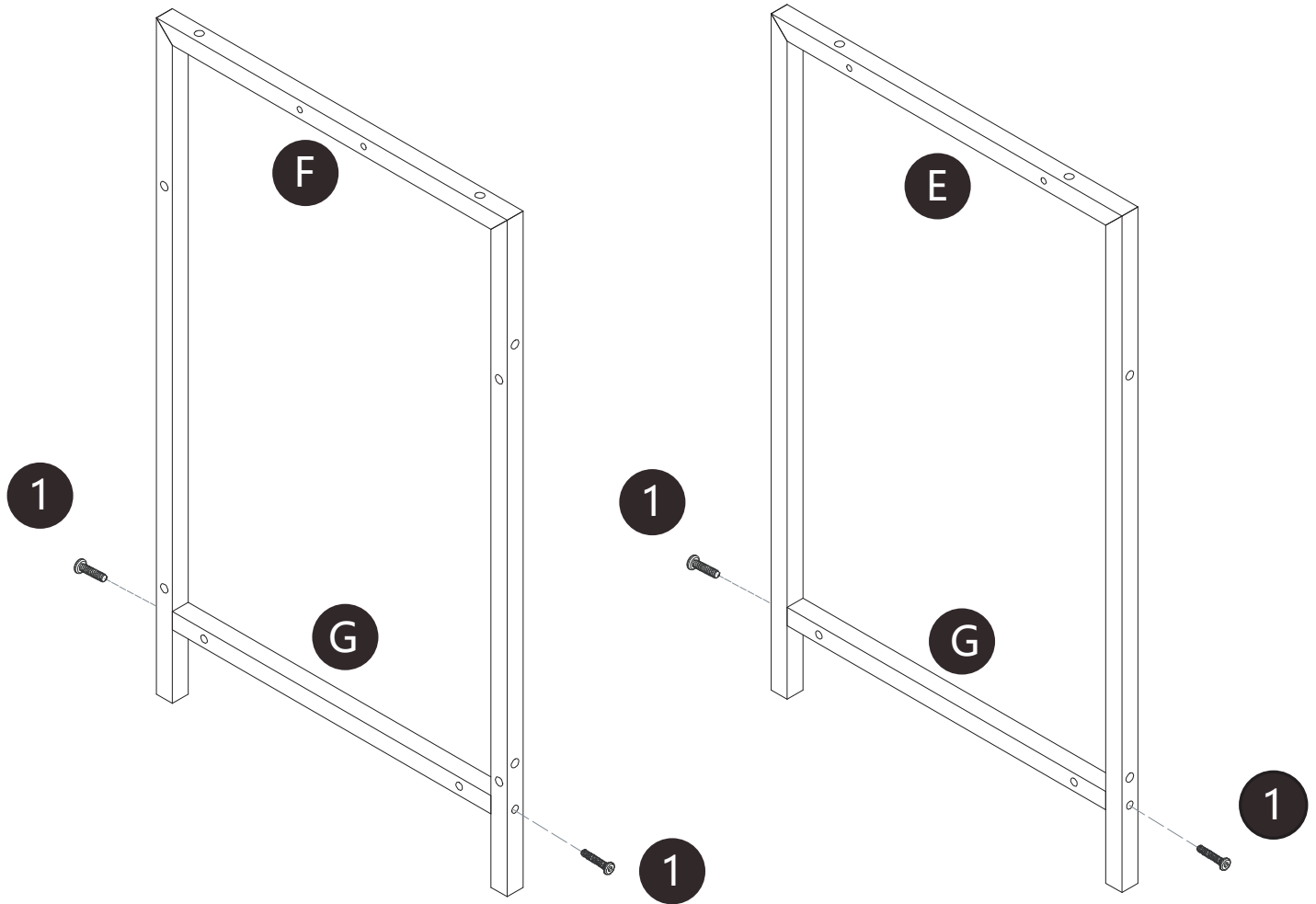

	
<b>1</b> x4	<b>6</b> x1

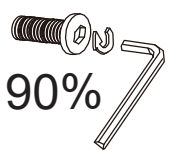

# Step 2

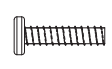

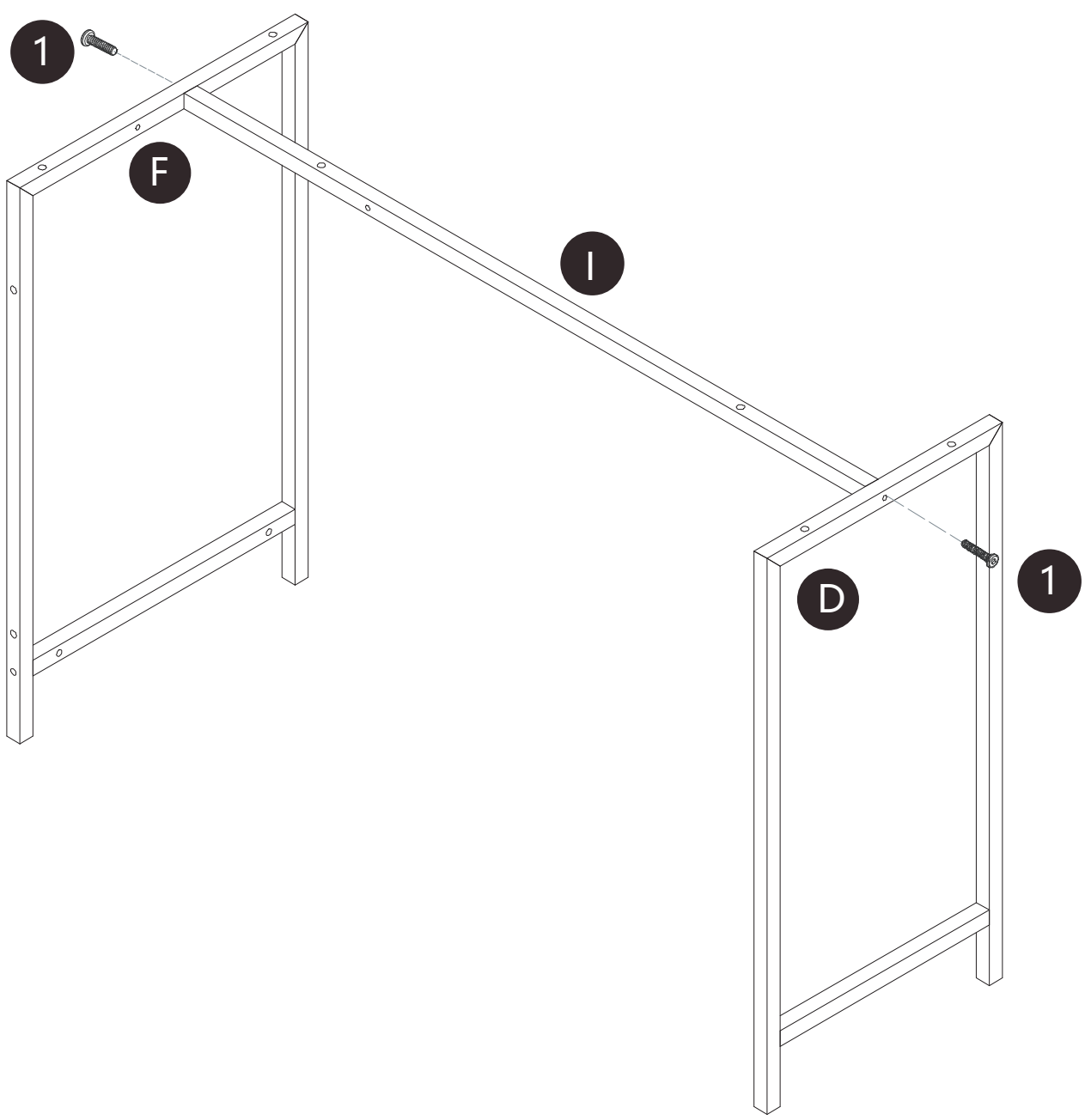

	
<b>1</b> x2	<b>6</b> x1

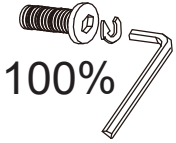

# Step 3



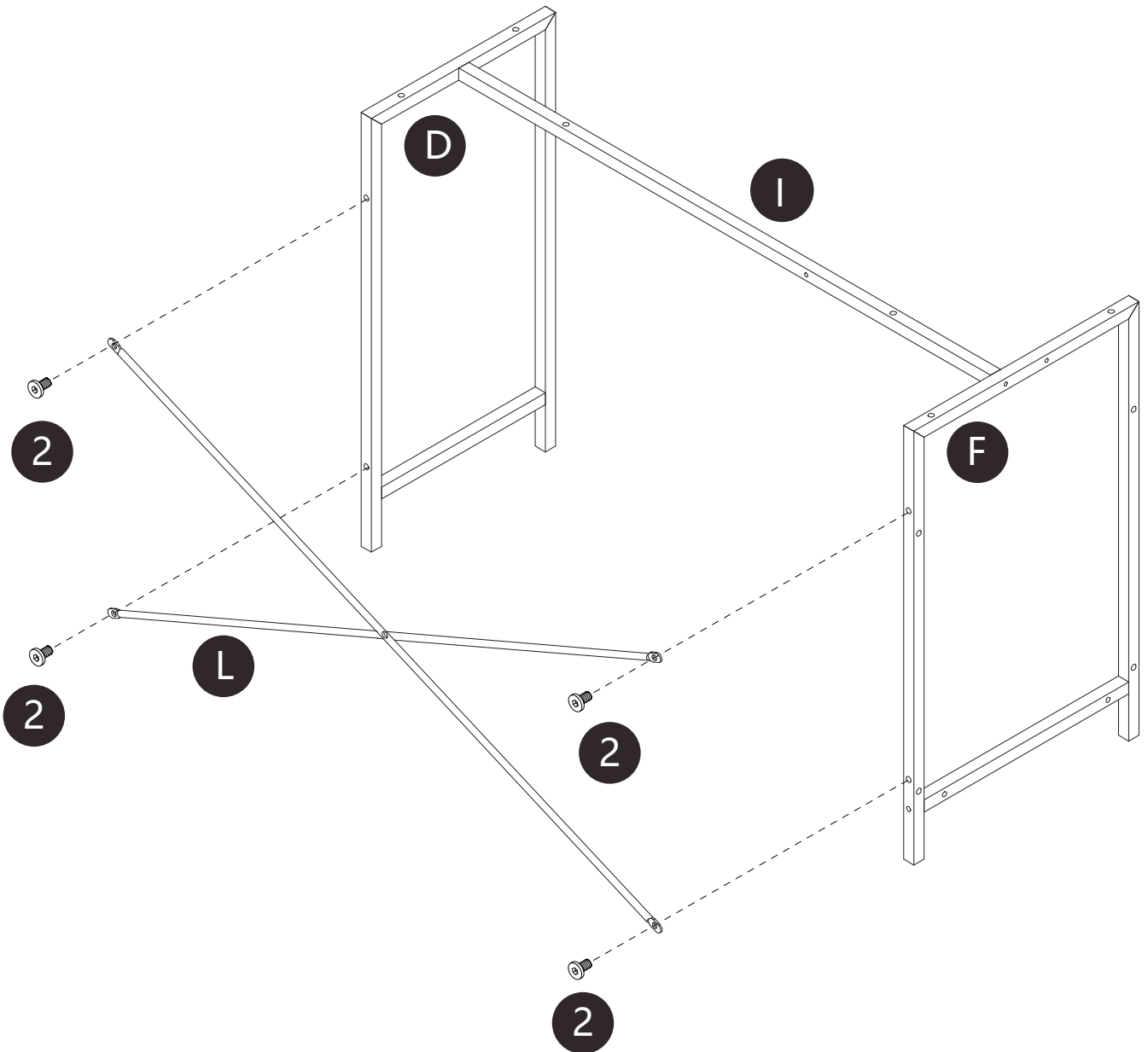

	
<b>2</b> x4	<b>6</b> x1

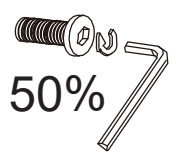

# Step 4



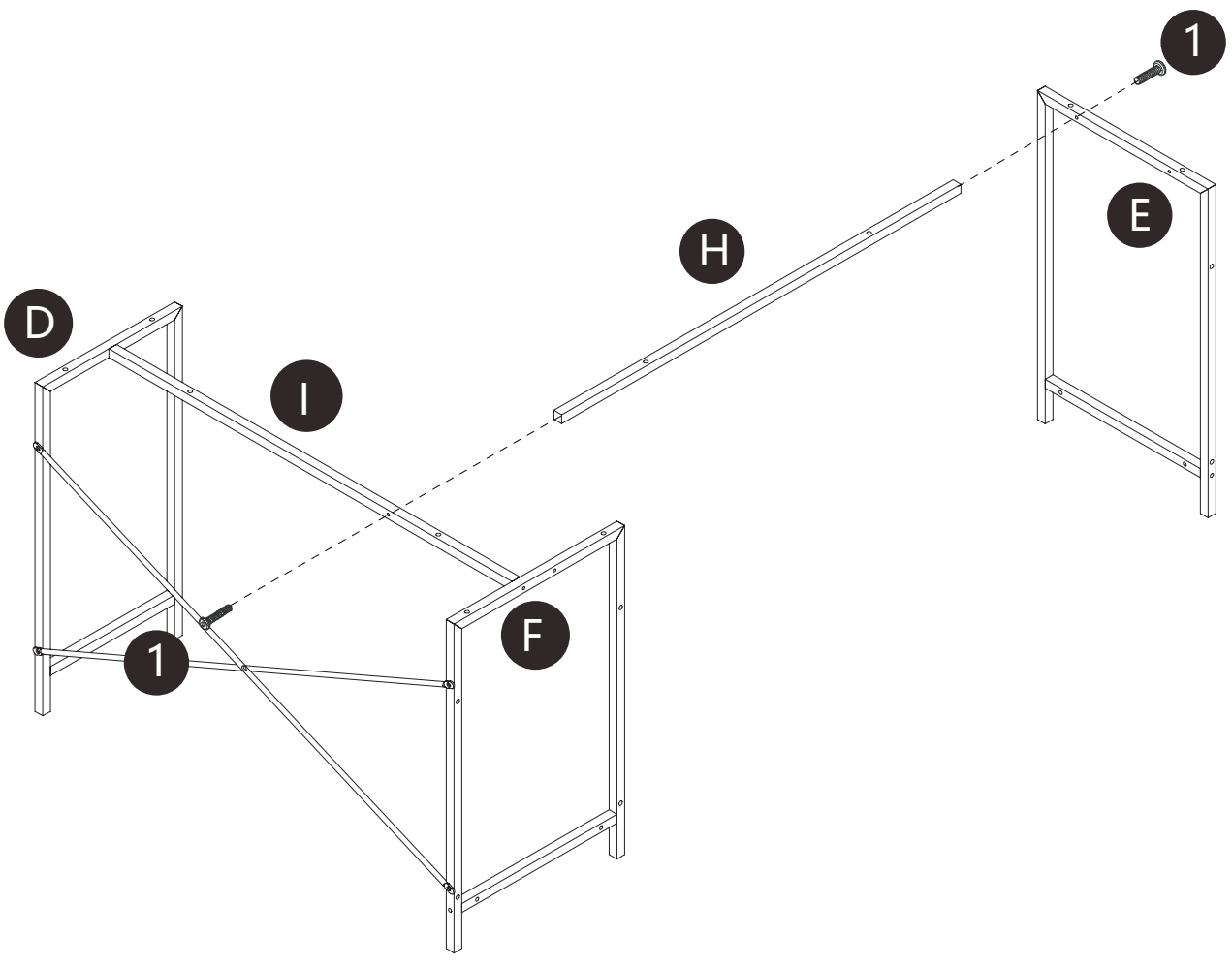

	
<b>1</b> x2	<b>6</b> x1

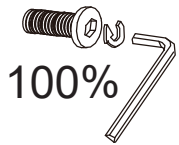

# Step 5



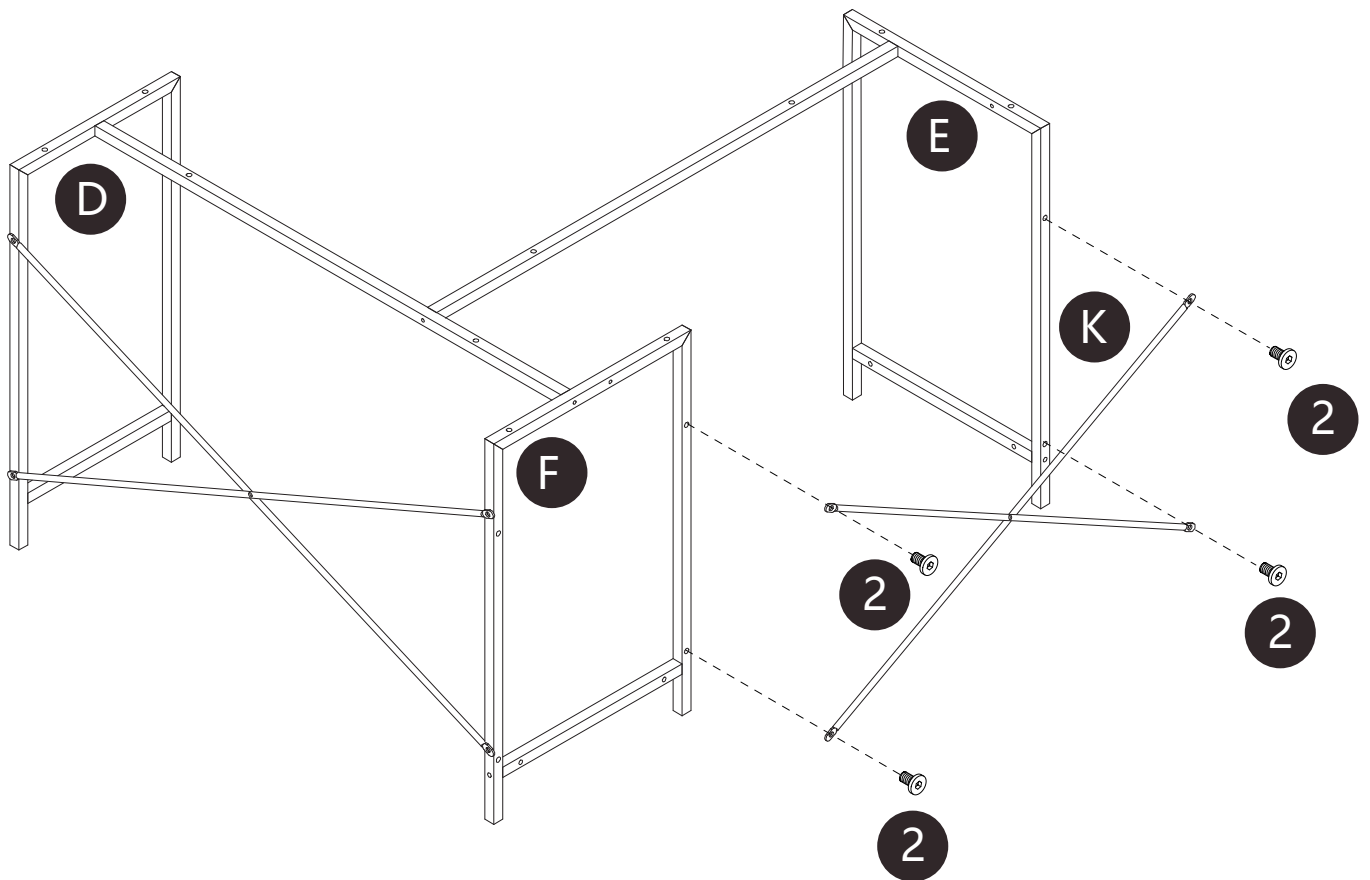

	
<b>2</b> x4	<b>6</b> x1



# Step 6



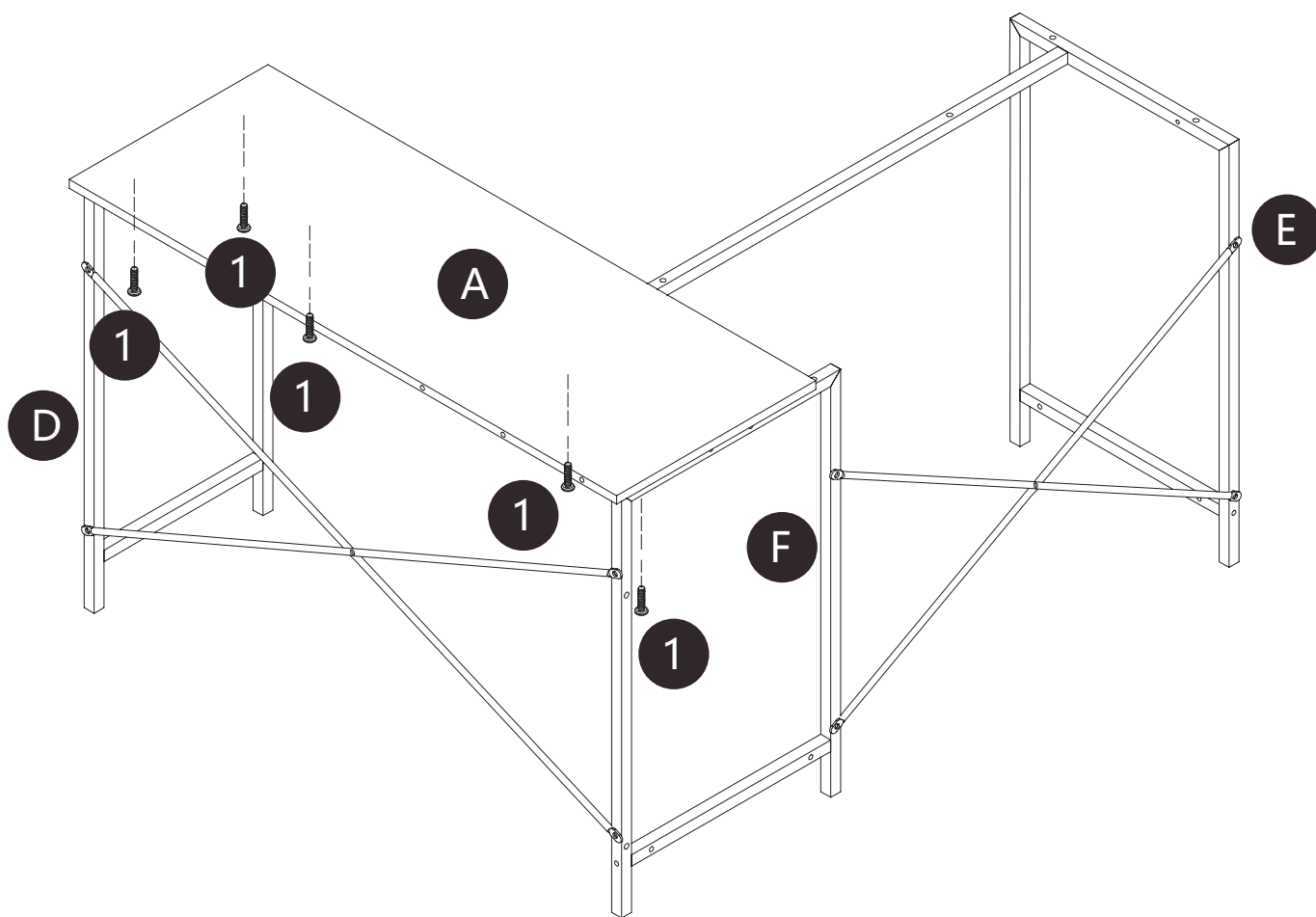

	
<b>1</b> x5	<b>6</b> x1



# Step 7

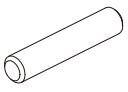

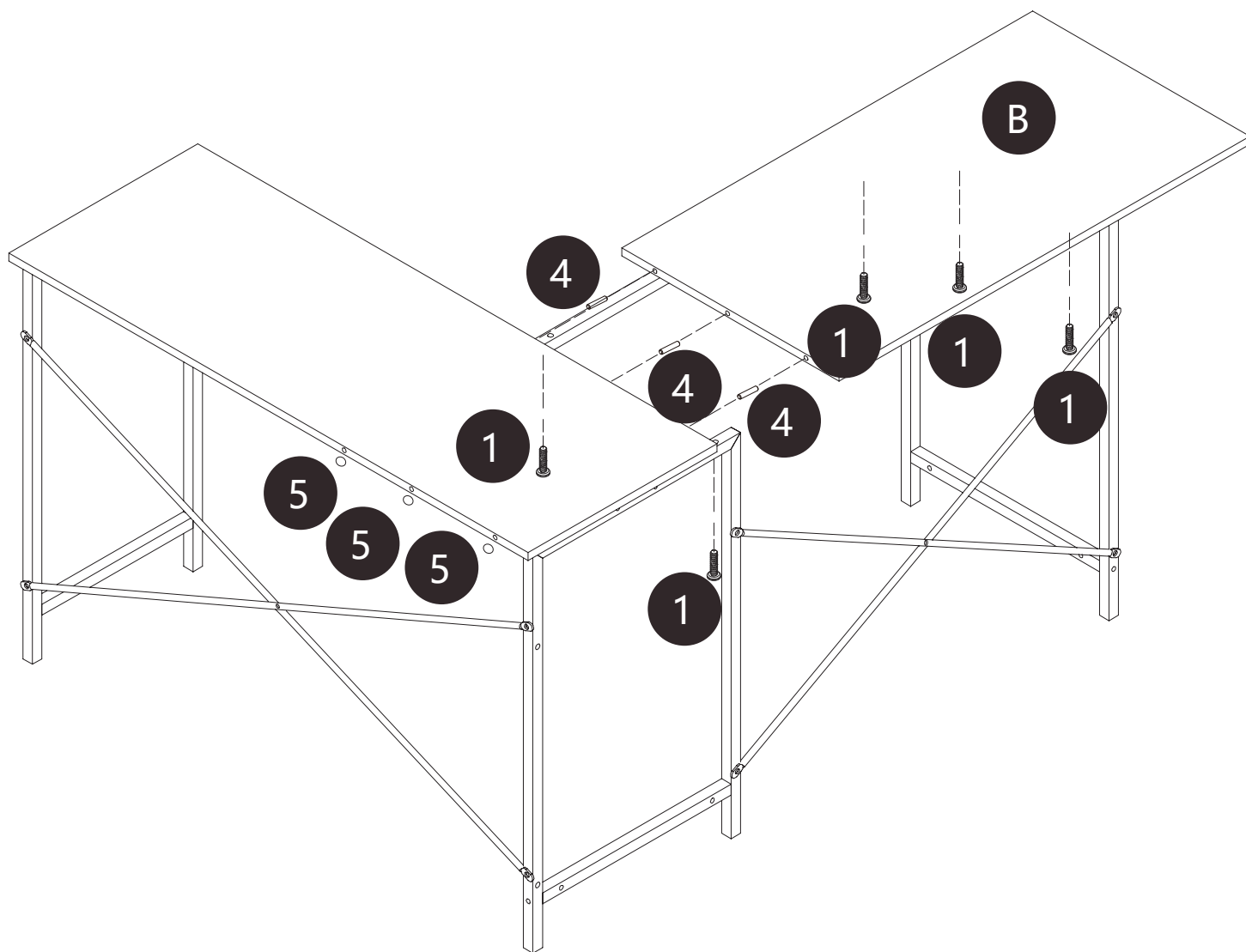

			
<b>1</b> x5	<b>4</b> x3	<b>6</b> x1	<b>5</b> x3

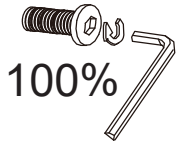

# Step 8

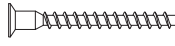

		
<b>1</b> x2	<b>3</b> x2	<b>6</b> x1

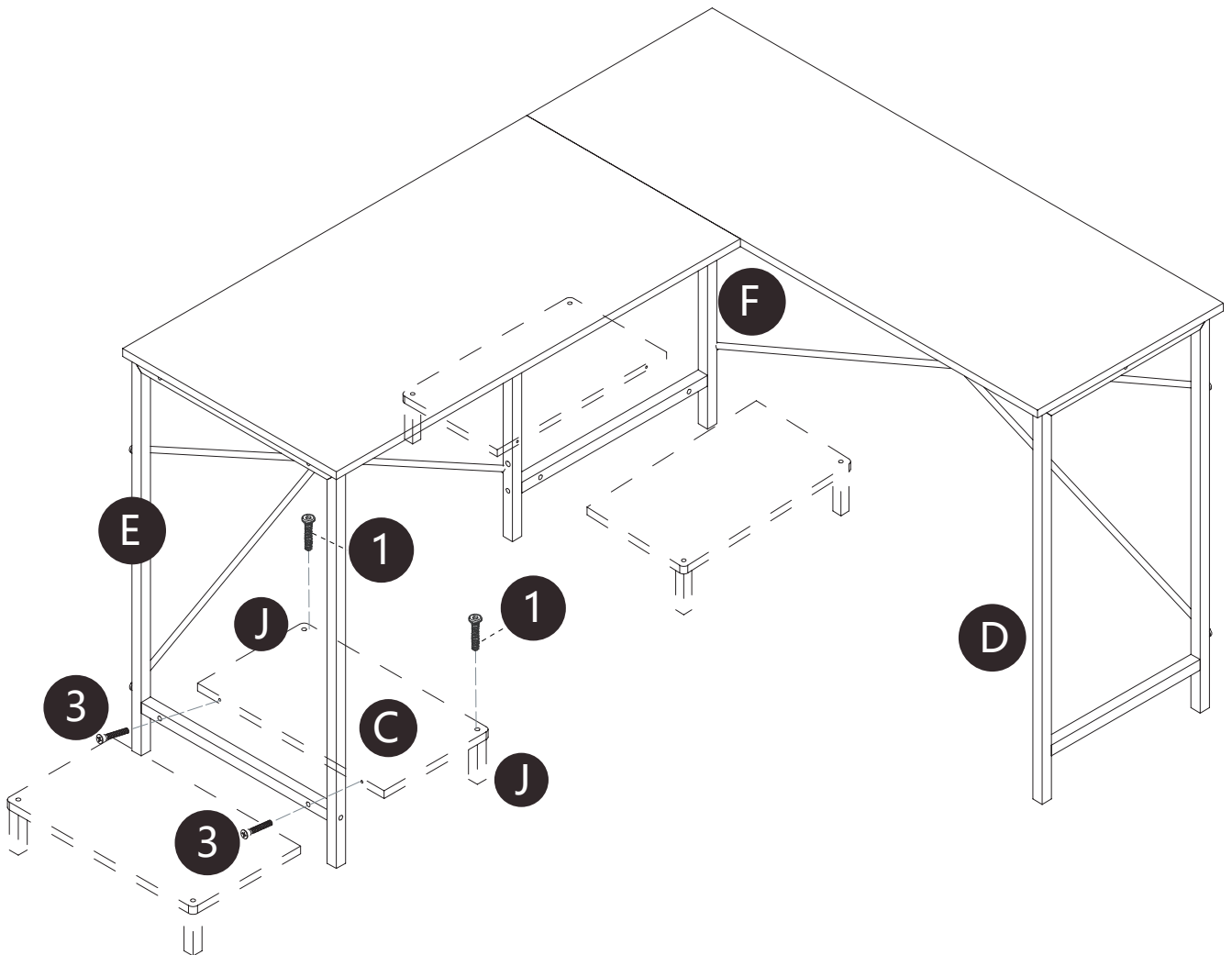

## NOTE:

Choose one desired location of Board **C** from the 4 locations marked in the diagram.

# Step 9

---

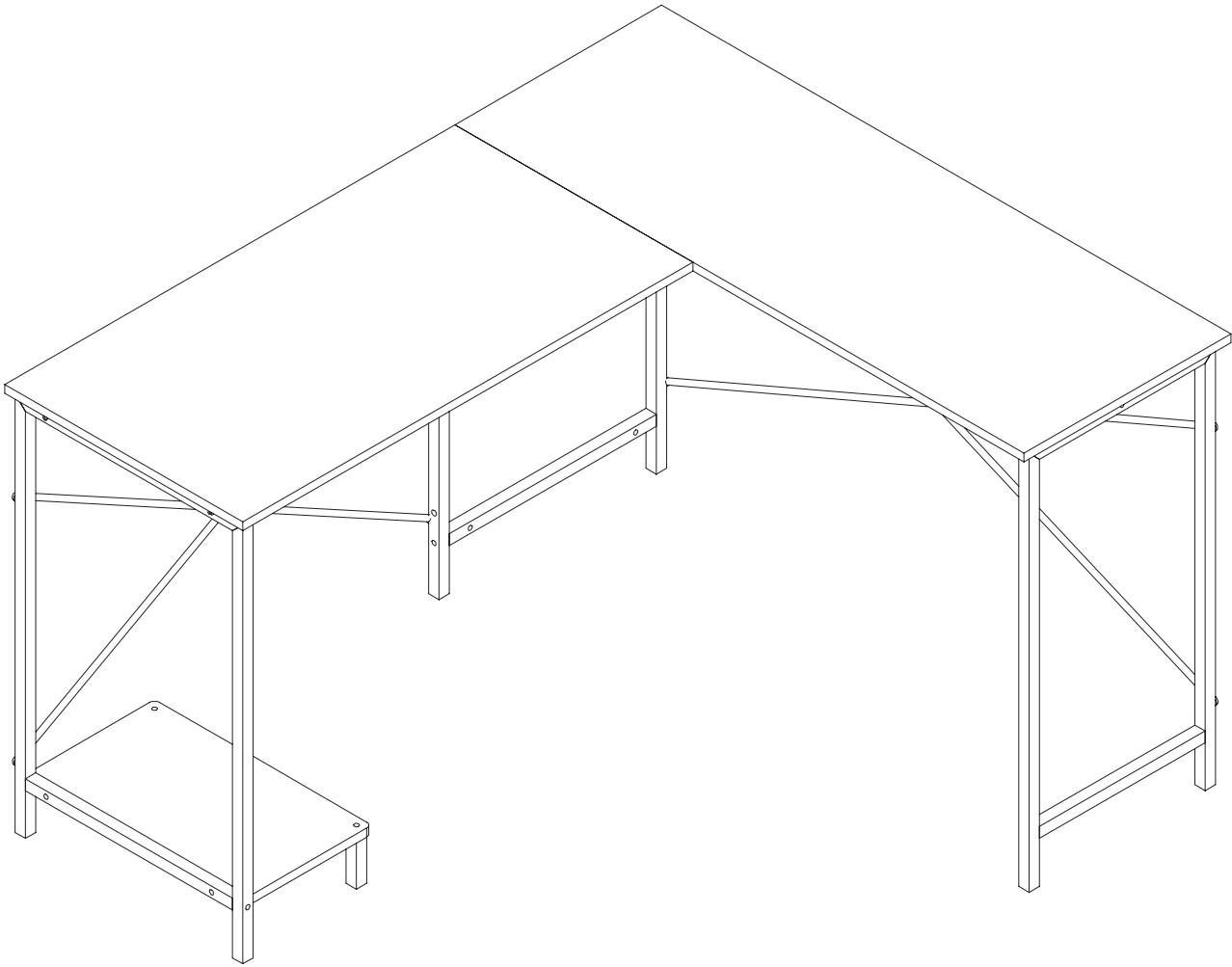



**NOTE: Make sure all screws are 100% tightened before use.**

# Option 2

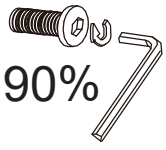
## Step 1



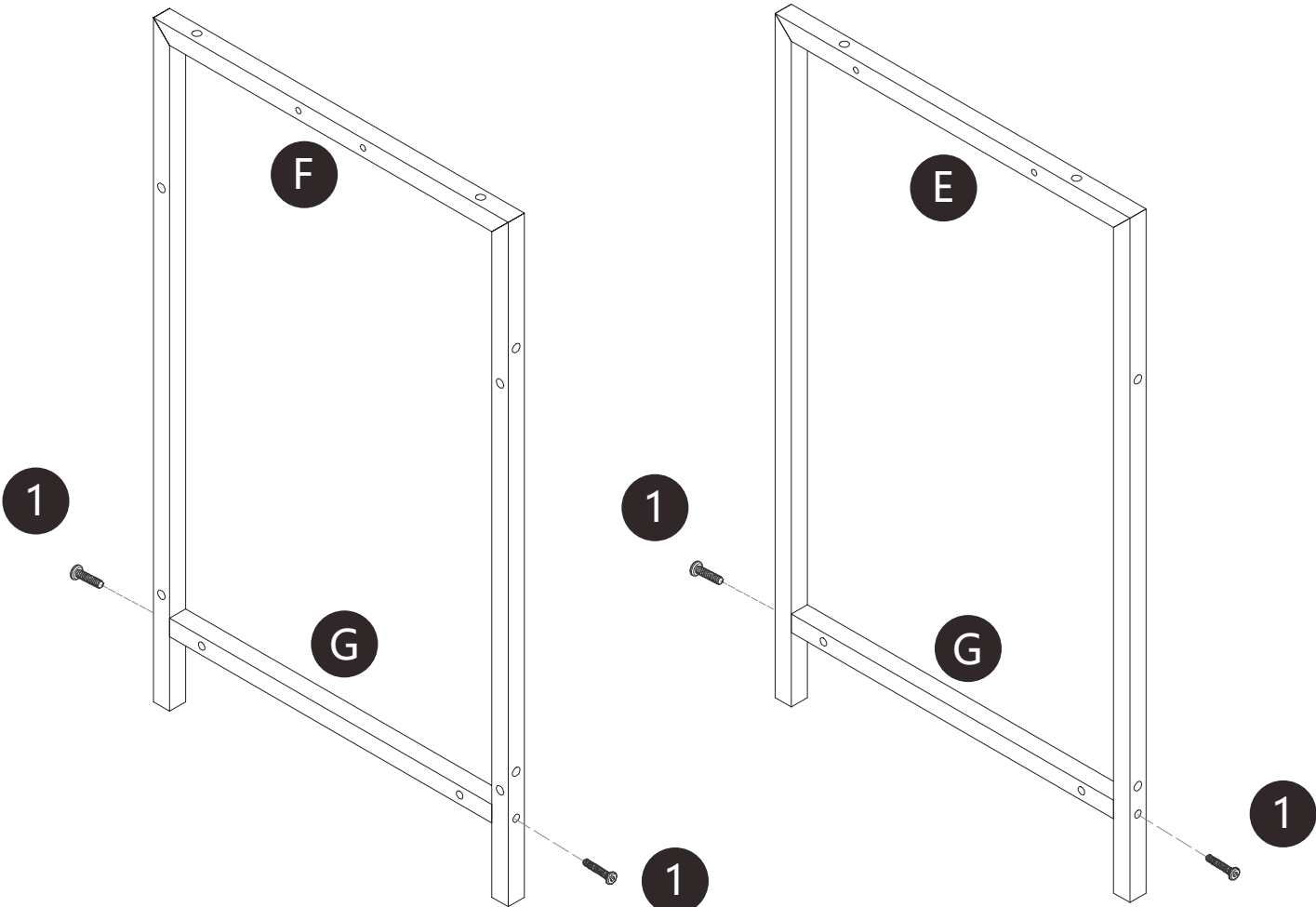

	
<b>1</b> x4	<b>6</b> x1

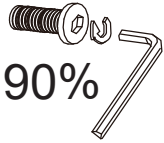

# Step 2



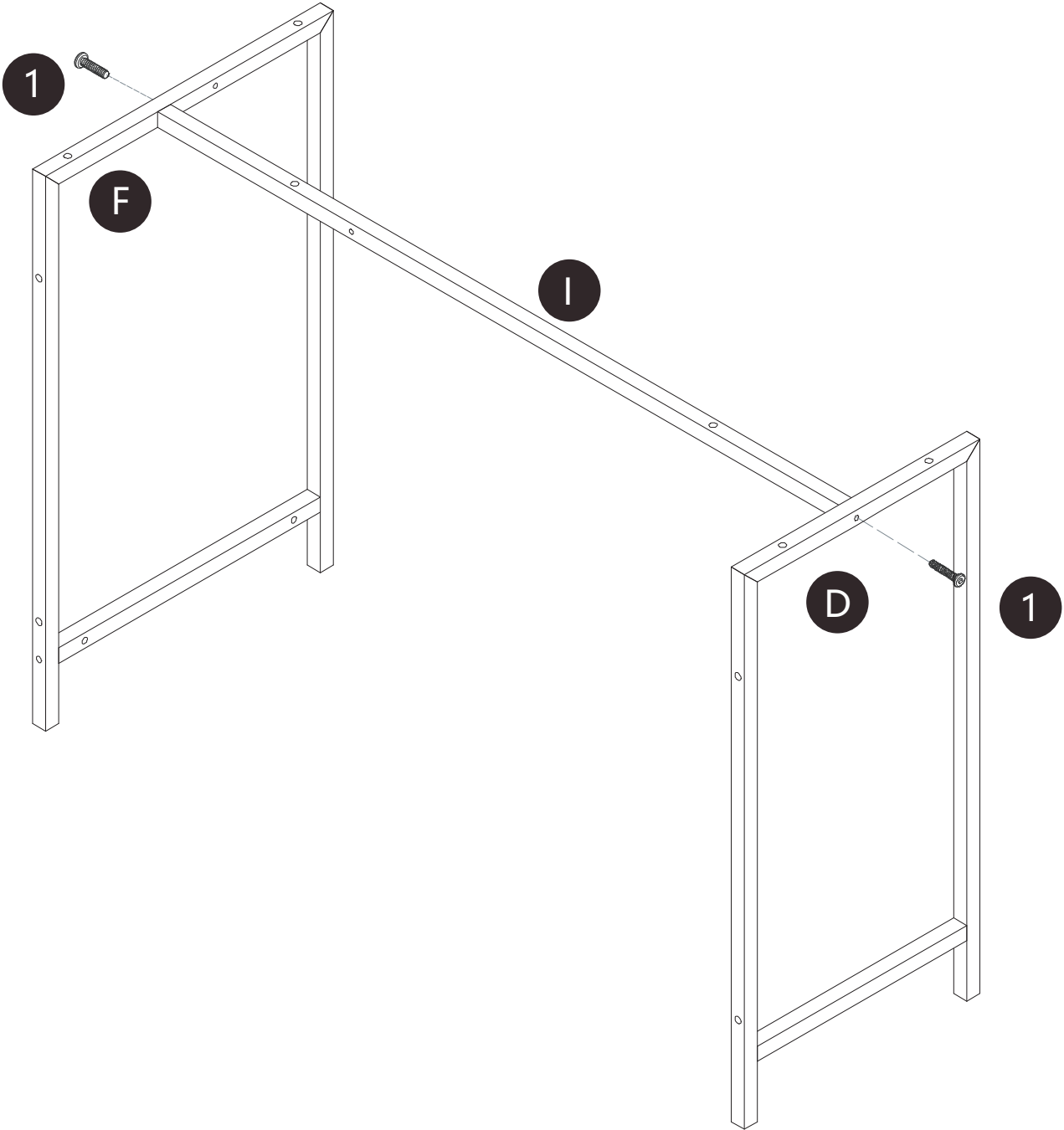

	
<b>1</b> x2	<b>6</b> x1

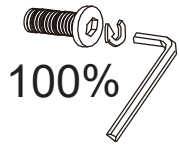

# Step 3



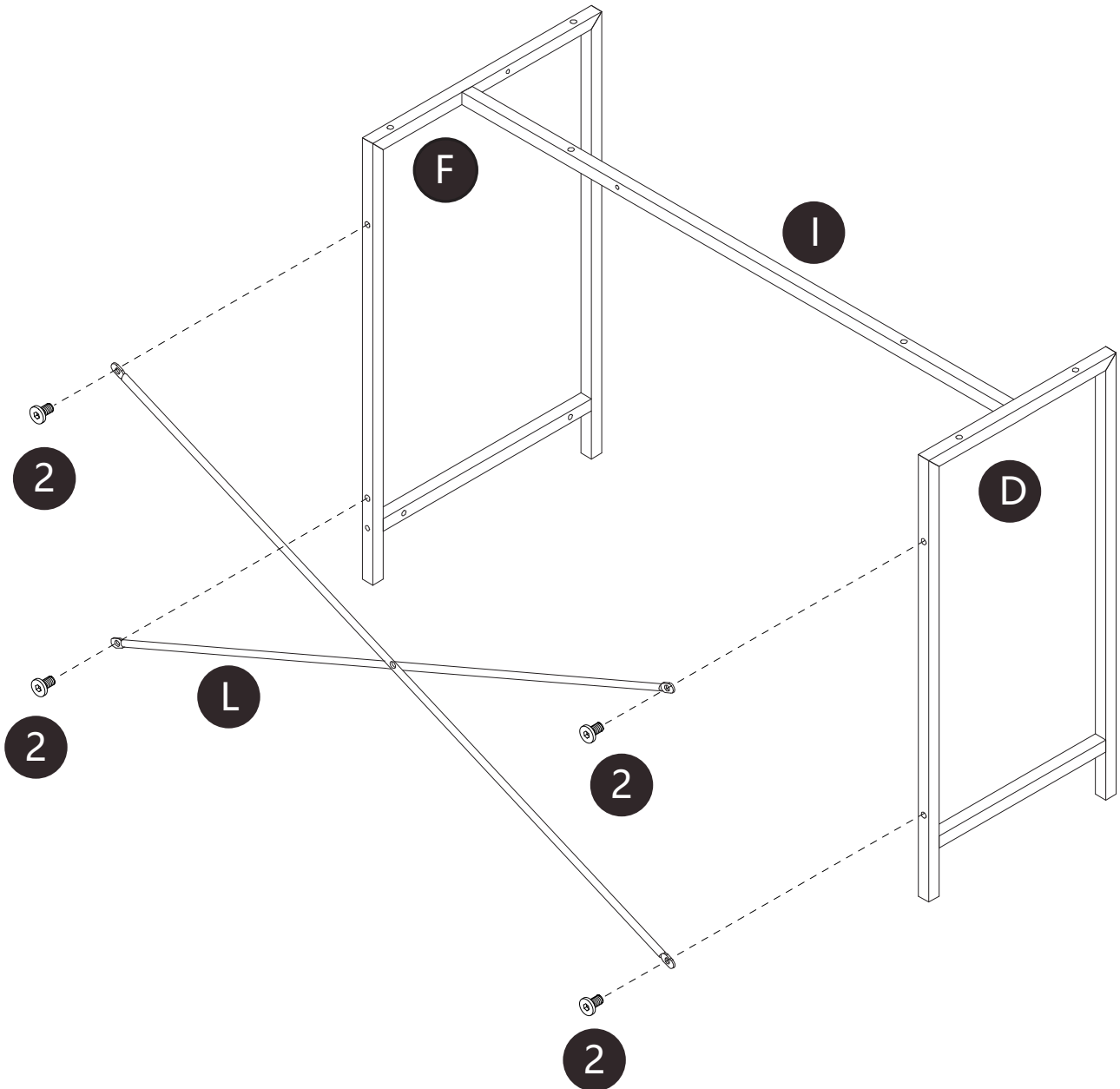

	
<b>2</b> x4	<b>6</b> x1

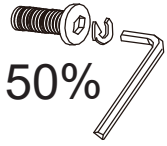

# Step 4



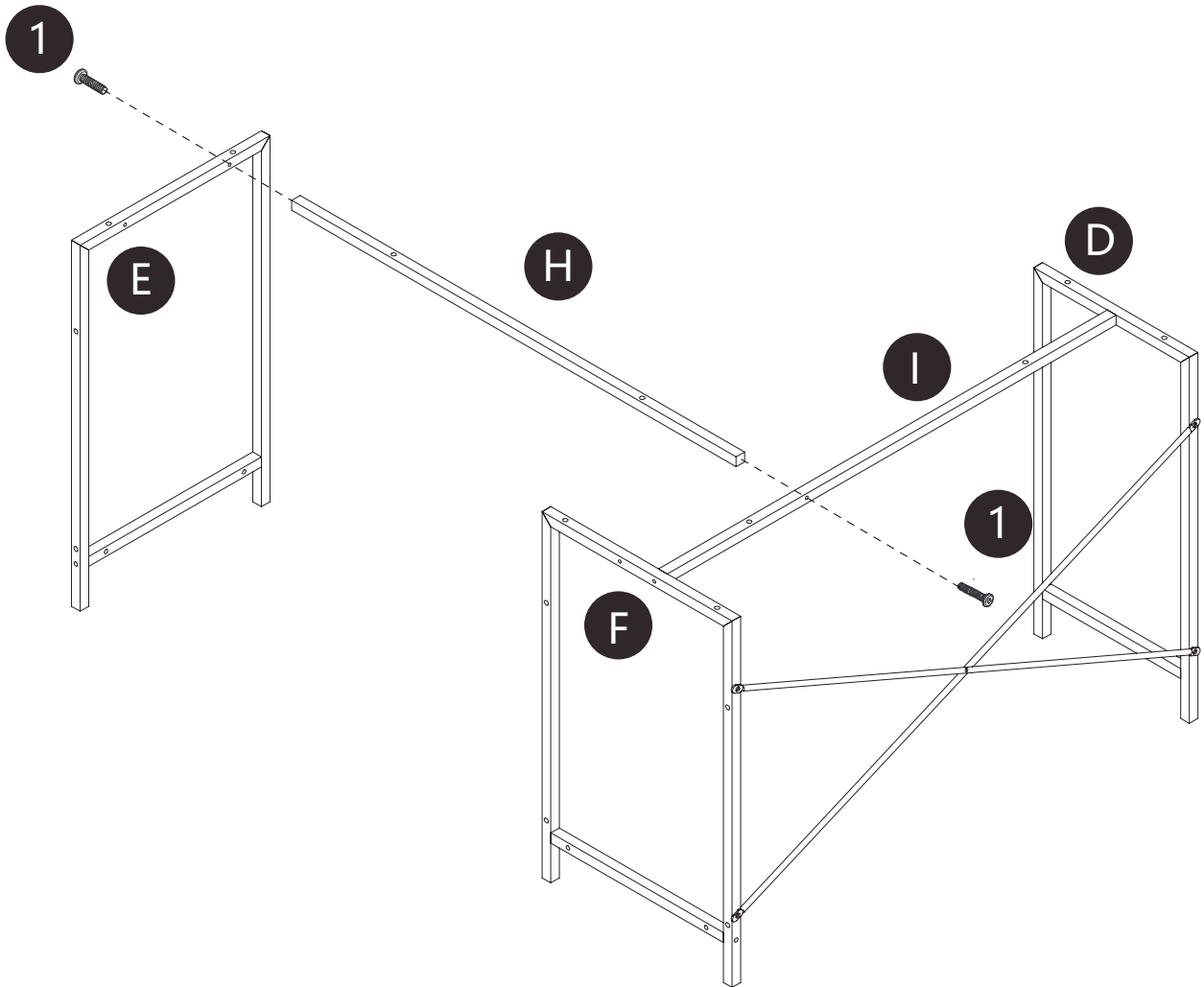

	
<b>1</b> x2	<b>6</b> x1

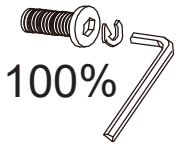

# Step 5



	
<b>2</b> x4	<b>6</b> x1

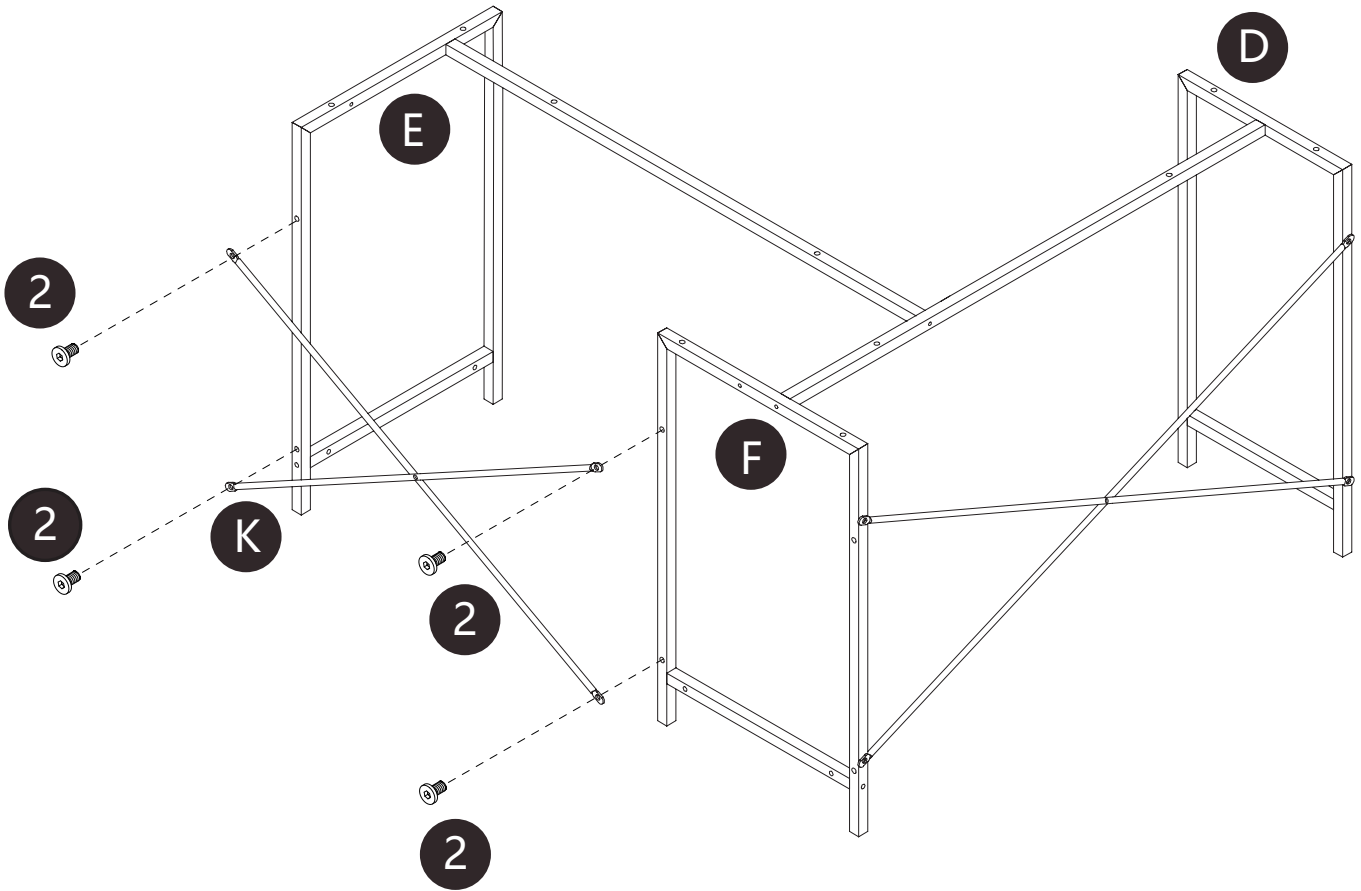

# Step 6



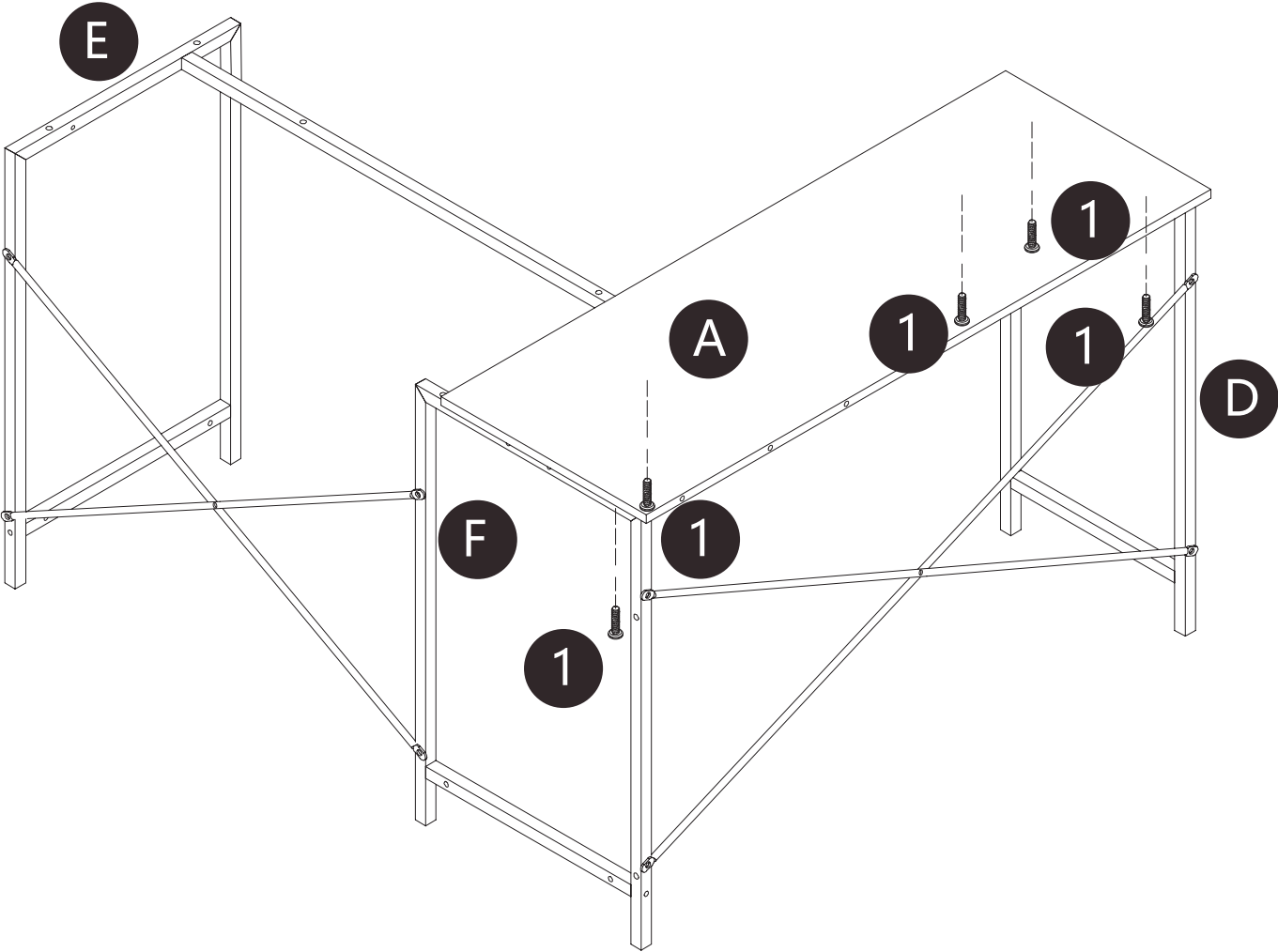

<b>1</b> x5	<b>6</b> x1



# Step 7

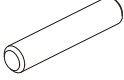

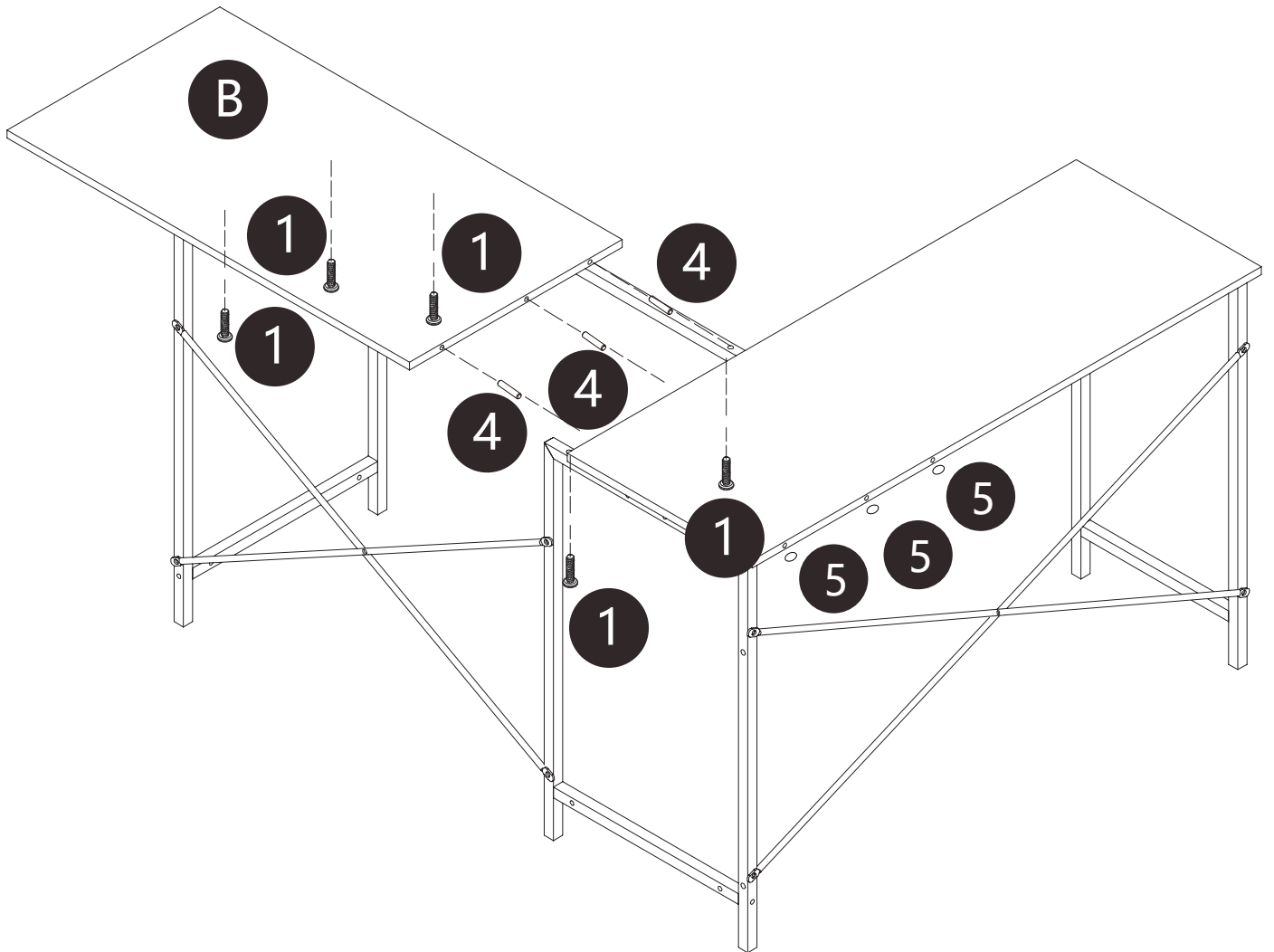

			
<b>1</b> x5	<b>4</b> x3	<b>6</b> x1	<b>5</b> x3

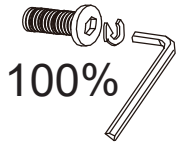

# Step 8

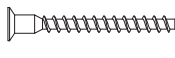

		
<b>1</b> x2	<b>3</b> x2	<b>6</b> x1

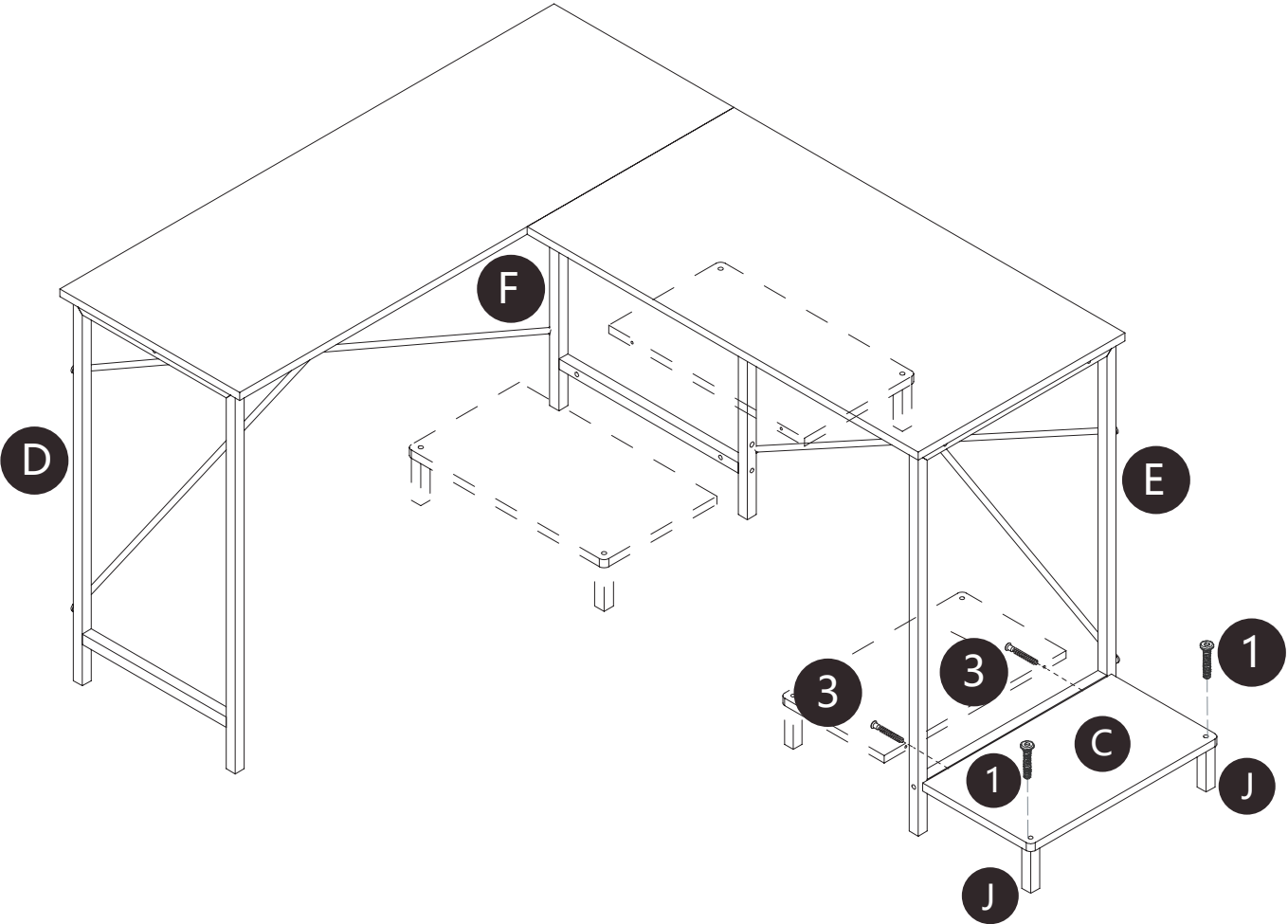

**NOTE:**

Choose one desired location of Board **C** from the 4 locations marked in the diagram.

## Step 9

---

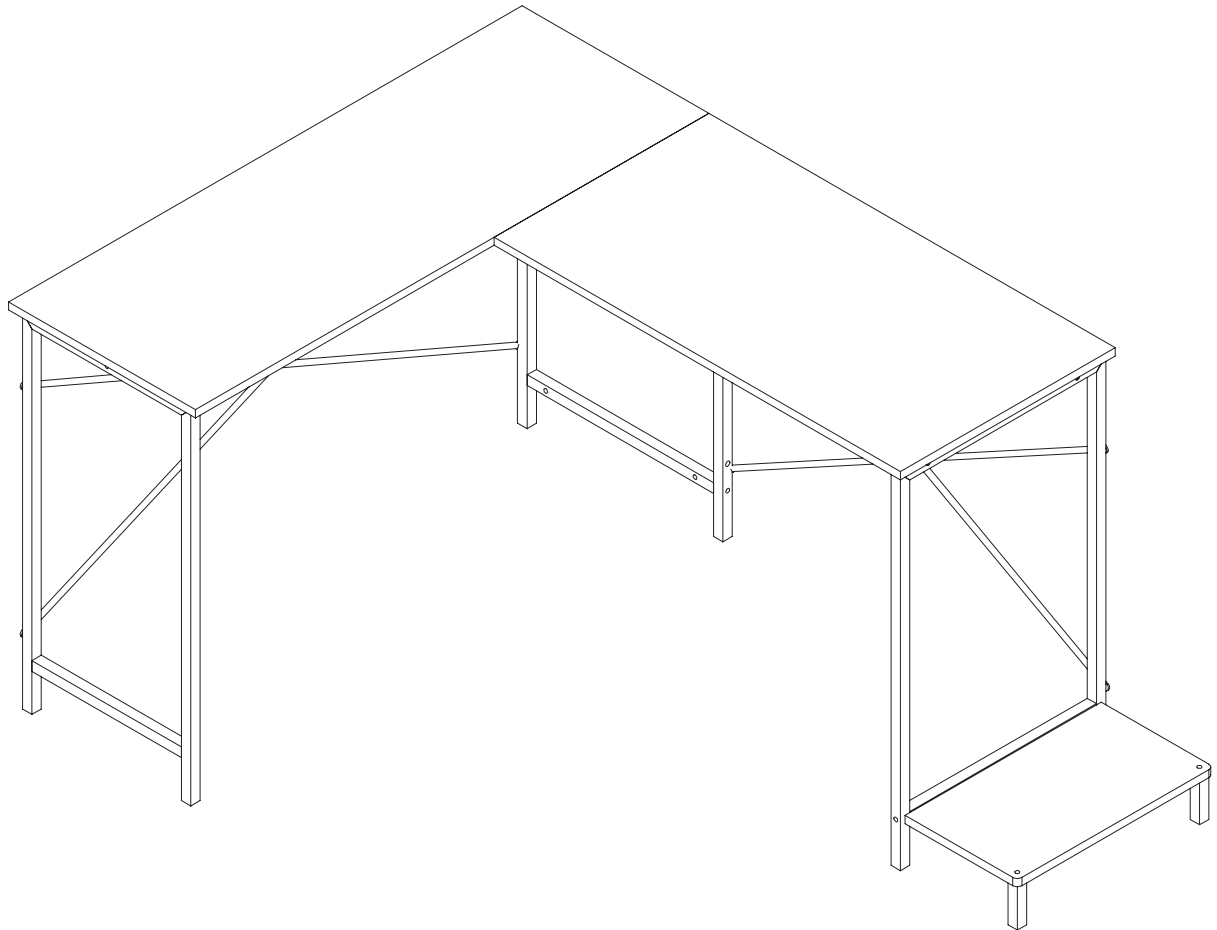

**NOTE:** Make sure all screws are 100% tightened before use.

