

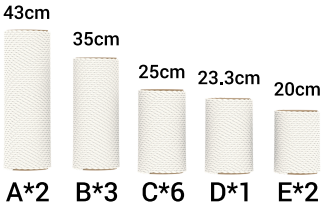
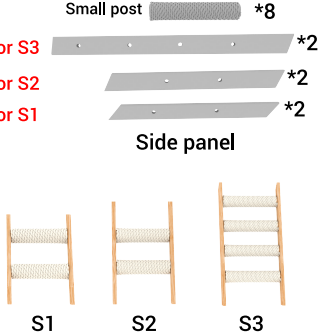
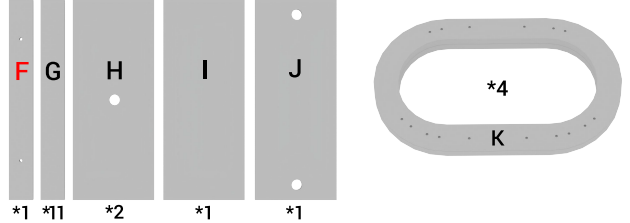
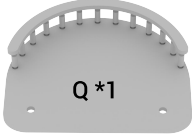
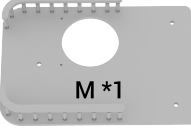
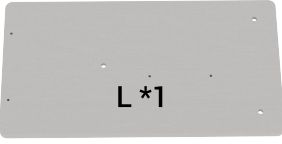
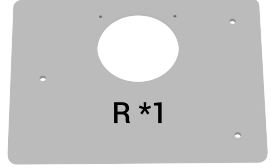
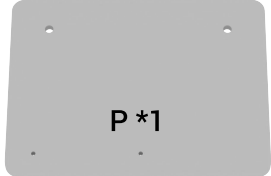

<p>Sisal column</p>  <p>43cm 35cm 25cm 23.3cm 20cm</p> <p>A*2 B*3 C*6 D*1 E*2</p>	<p>a. *70</p> <p>b. *6</p> <p>c. *16</p> <p>d. *7</p> <p>e. *10</p>	<p>Ladder set</p> <p>Small post *8</p> <p>For S3 *2</p> <p>For S2 *2</p> <p>For S1 *2</p> <p>Side panel</p>  <p>S1 S2 S3</p>	<p>Cat box</p>  <p>F G H I J</p> <p>*1 *11 *2 *1 *1</p> <p>*4 K</p> <p>The F board of T1 has two screw holes</p>	<p>Space Bowl</p> <p>N *1</p> <p>Space Bowl Rack</p> <p>O *1</p>	
<p>Used for the overall vertical structural connection of the product, corresponding to the product number at each position.</p>					
<p>Viewing Platform on floor 3-4</p>  <p>Q *1</p> <p>Small post *8</p> <p>Board *1 Fence*1</p>	<p>Viewing Platform on floor 4-5</p>  <p>M *1</p> <p>Small Post *22</p> <p>Board *1 Fence *2</p>	<p>Chassis</p>  <p>L *1</p> <p>43.31"*23.62"</p>	<p>Springboard on floors 1-2</p>  <p>R *1</p> <p>23.62"*31.5"</p>	<p>Springboard on floors 3-4</p>  <p>P *1</p> <p>23.62"*17.72"</p>	<p>Installation tools</p>  <p>screwdriver allen key</p>
<p> Nail Free Glue *4 2 more small post for spare use</p>					
 <p>T1=T1 F T1</p> <p>T2=T2</p> <p>Q</p> <p>M</p> <p>S1 S2 S3</p> <p>T1=F+G*5+H*2+K*2 T2=G*6+I+J+K*2</p> <p>For the convenience of installation, it is recommended to assemble T1, T2, Q, M, as well as S1, S2, S3 in advance, and then install the overall part from bottom to top.</p>					

Attention: To protect the durability of the wood and product, the surface of the solid wood of the product is coated with natural wood wax oil which is environmentally friendly, non-toxic, and odorless, and disposable gloves can be worn during installation.

I: Litter Box Installation

1. Use model (a) screws to screw into all white screw holes on the mode (M) fitting.
2. Insert the type (F.G.H.I.J) plate into the (a) screws according to the positional relationship in the picture, first into the lower part of the insertion, and then align the upper part.
3. Check the screws aligned with the holes, the left and right sides of the uniform force at the same time to press, so that it is firm and no gaps. If the force is small, you need to pad thick cardboard on the board and then use the tool to tap.

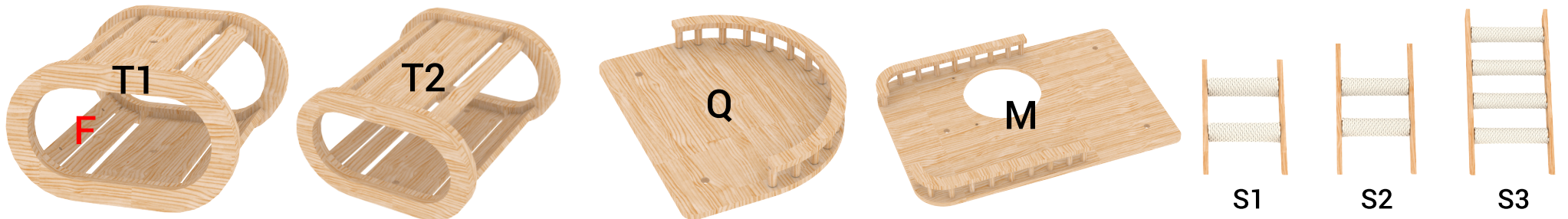
TIPS:

1. The side with more boards is the bottom of the cat box.
2. The two screw holes on the F board of T1 correspond to the top of the staircase (S1) on the first floor, pay attention to the installation direction of T1.

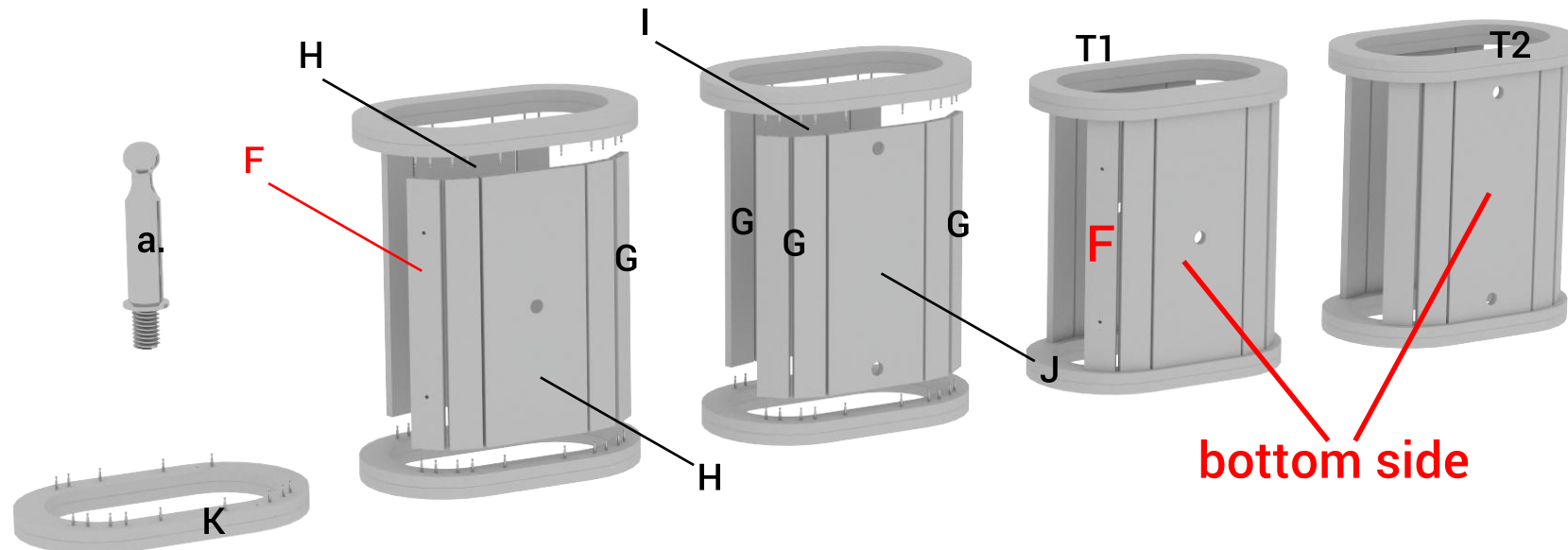

II: Installing the ladder

1: Install the ladder on both sides of all with **type (c) screws**.

2: Note that the openings at both ends of the ladder are different and need to be oriented in a uniform way.

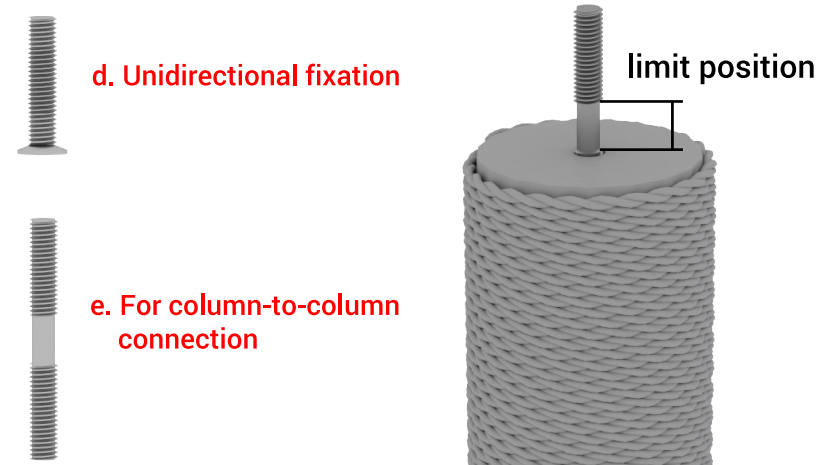
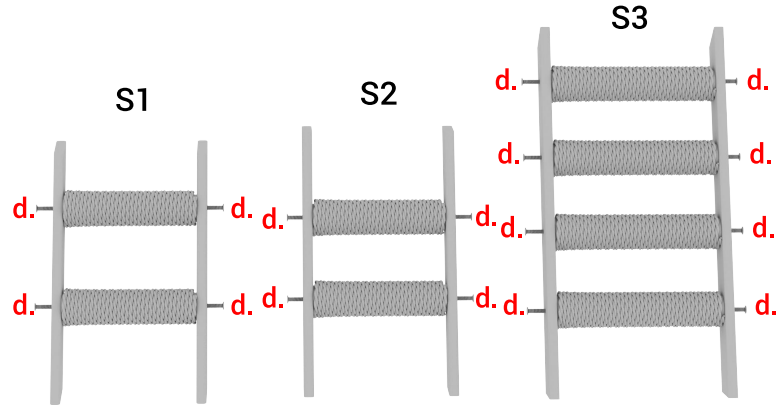

III: Bottom Mount

The side with a large hole on the bottom plate(L) faces downwards.

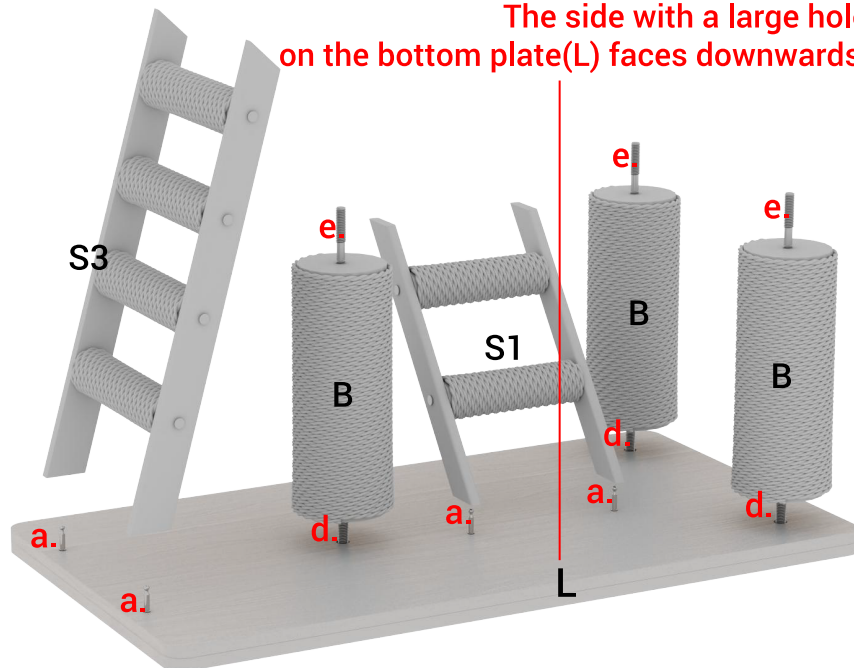

IV : Middle Mount

