

Manual Book

Chandelier

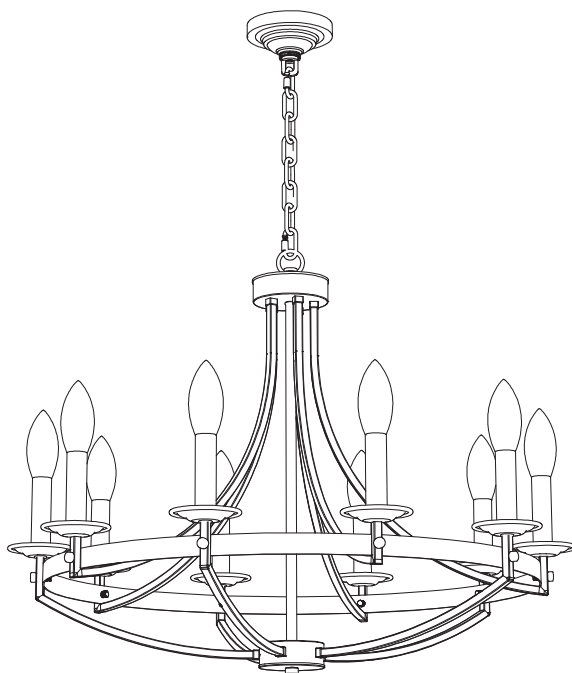

Contact Information

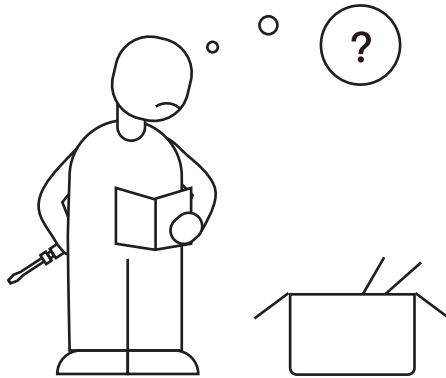

Please contact us with the following information:

1. Screenshot of your order page, including product picture, name, and order ID number.
2. Problem details with pictures / short video if possible.

Packing List

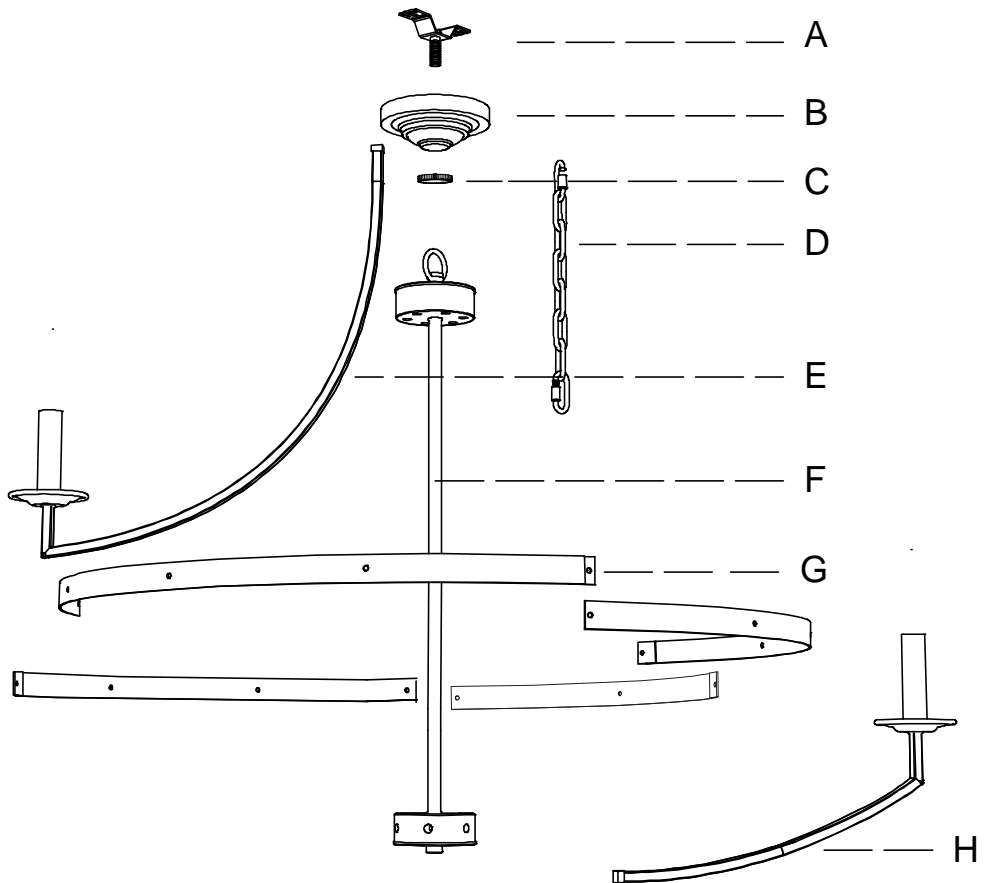

Part	Description	Quantity
A	Mounting Bracket	1
B	Canopy	1
C	Fixed Buckle	1
D	Sling Chain	1
E	Lamp Arm A	5

Part	Description	Quantity
F	Lamp Pole	1
G	Lamp Body	4
H	Lamp Arm B	5

NOTE: A and C are pre-assembled.

Installation Kit



AA

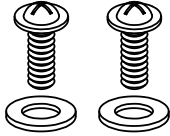

BB

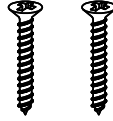

CC



DD



EE

Part	Description	Quantity
AA	Wire nut	7
BB	Machine Screw & Washer for Outlet Box (spares)	2
CC	Wood Screw (optional)	2
DD	Pair of Gloves	1
EE	Flower Branch Nut	10

Note:

1. Some extra hardware may be included. The quantity listed above is the number required for installation.
2. Accessory "EE" includes 4 long ones and 6 short ones.

Safety Rules

WARNING: BE SURE THE ELECTRICITY TO THE WIRES YOU ARE WORKING ON IS SHUT OFF; EITHER THE FUSE IS REMOVED OR THE CIRCUIT BREAKER IS TURNED OFF. TURNING THE POWER OFF USING THE LIGHT SWITCH IS NOT SUFFICIENT TO PREVENT ELECTRICAL SHOCK.

NOTE: The important safeguards and instructions appearing in this manual are not meant to cover all possible conditions or situations that may occur. It must be understood that common sense, caution, and care, are factors which cannot be built into any product. These factors must be supplied by the person(s) installing this unit.

READ & SAVE THESE INSTRUCTIONS

CAUTION: Before assembling the lighting fixture, please read the following chapters. If you feel you do not have enough electrical wiring experience, either refer to a do-it-yourself wiring handbook or have your lighting fixture installed by a qualified, licensed electrician. Remove the fixture and the mounting packages from the box and make sure that no parts are missing by referencing the illustrations on the installation instructions.

Be sure to read these installation instructions and review the diagrams thoroughly before installation.

LIGHT BULBS REQUIRED

This lamp uses 12 E12 bulbs, compatible with bulb up to 40W. Fully dimmable when used with dimmable bulbs and compatible dimming switches (not included).

Installation Preparation

Tools You Need

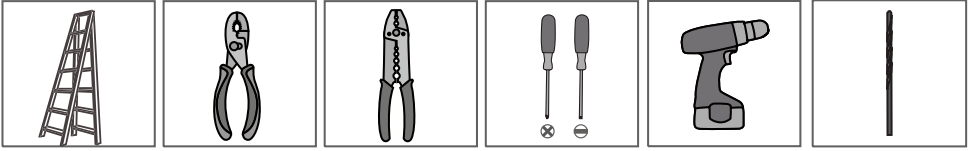

Ladder

Pliers

Wire Strippers

Screwdrivers

Power Drill (optional)

Drill Bit (optional)

If mounting to a support structure, you will also need the optional tools.

Installation Step 1 (Assemble the Light Arm)

1. Install light arm

Step 1. Rotate the lift ring and nut to open the box with holes.

Step 2. Insert the light arm into the box with holes as shown in the diagram.

Step 3. Fix the light arm to the box using the fixing nut.

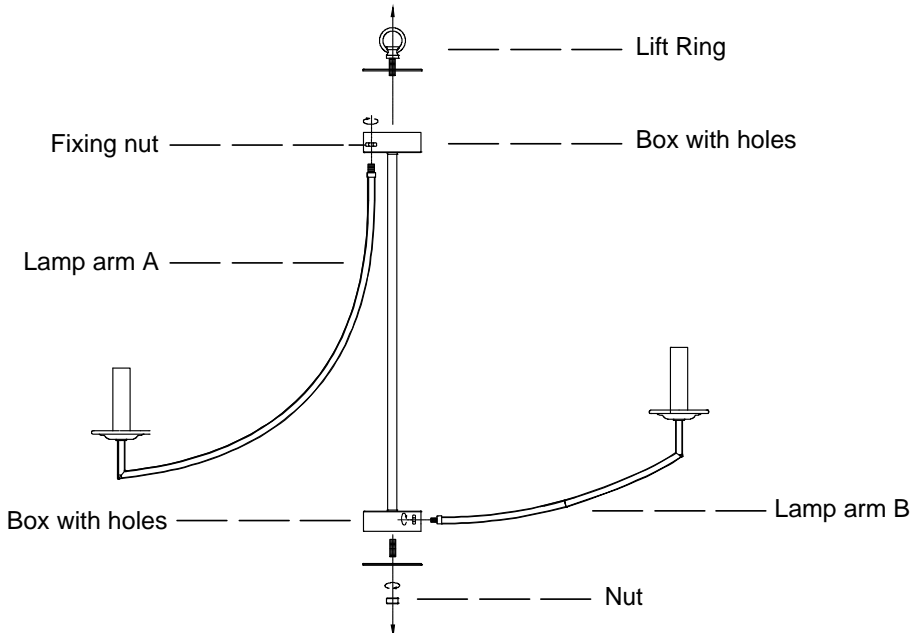

Installation Step 2 (Wire the Light Arm Wires)

2. Wire the light arm wires

Step 1. Connect the wire of lamp arm B to the bottom of the wire in the lamp pole, (black to black, white to white).

Step 2. Connect the wire of lamp arm A to the top of the wire in the lamp pole and connect it to the main wire (black to black, white to white).

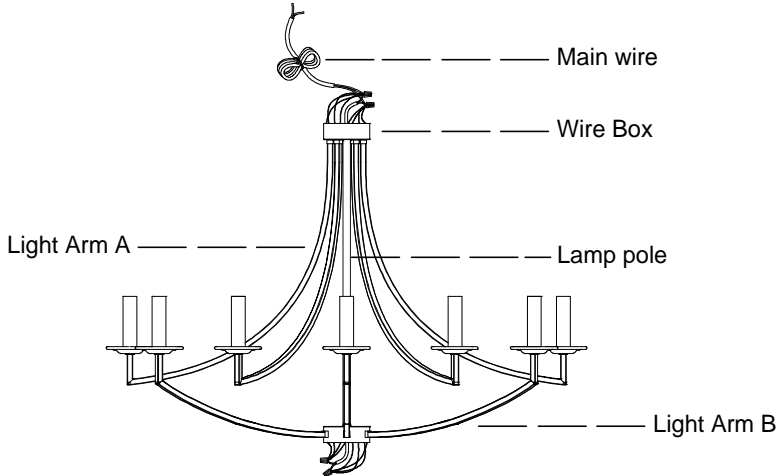

Step 3. Fix the cover of the top and bottom wire boxes securely.

Step 4. Fix the screw on the lift ring with a screwdriver.

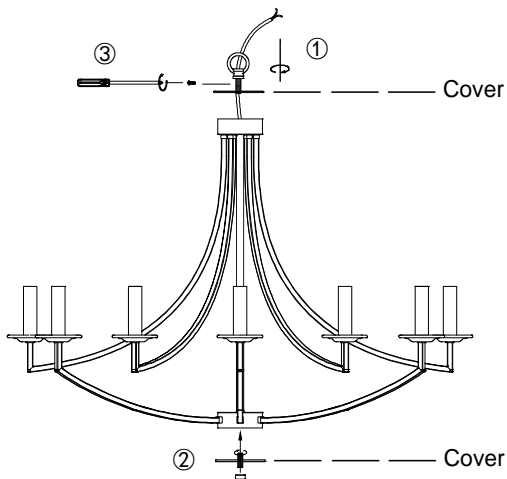

Installation Step 3 (Assemble the Light Body)

3. Assemble the light body

Fix the lamp arm to the lamp body through screws that fixed by flower branch nut (outside) and fixed nut (inside) at both ends.

Note:The screws at the splice are longer than others, please pay attention to distinguishing during installation.

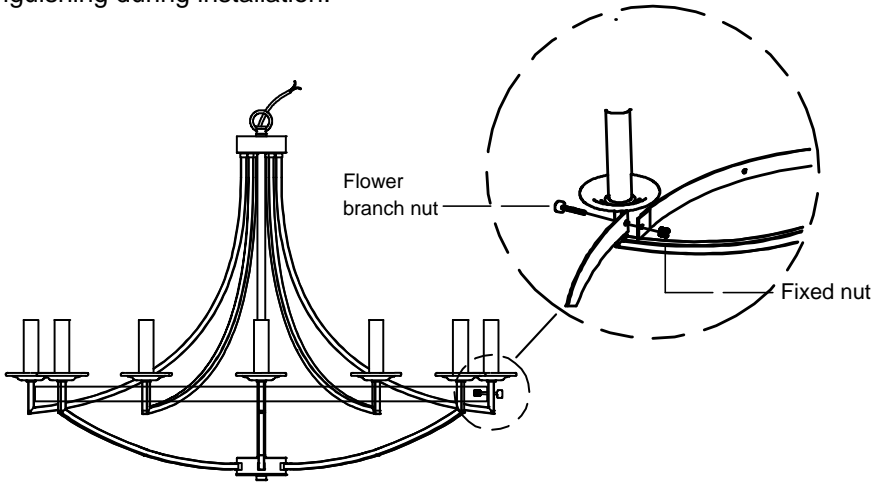

4. Install the Mounting Bracket

Secure the mounting bracket to the ceiling outlet box or solid wood structure with the screws and washers provided, and then take off the fixed buckle (C).

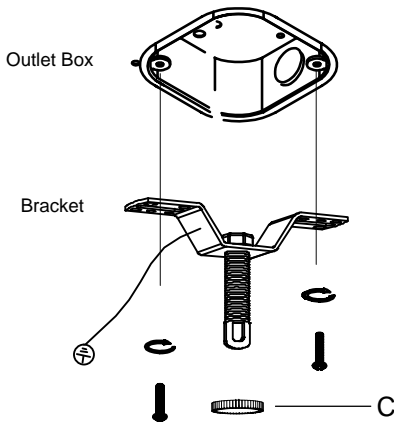

OR

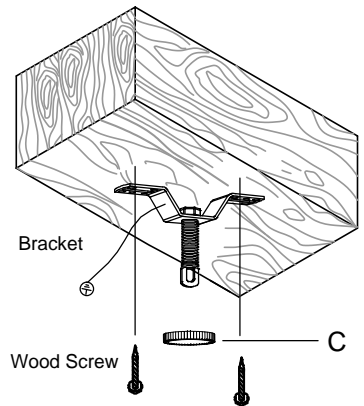

Installation Step 4 (Hang and Wire)

5. Hang and Wire

Step 1. Pass the main wire through the sling chain, fixed buckle, canopy, and bracket in sequence.

Step 2. Connect the wires according to the diagram, ground wire (green, green/yellow, or bare copper) to ground wire, neutral wire (white) to neutral wire, and hot wire (black) to hot wire. Wrap the connection with electrical tape.

Step 3. Connect both ends of the sling chain to the bracket and lift ring.

Step 4. Slide the canopy up to the ceiling, rotating fixed buckle to fix the canopy.

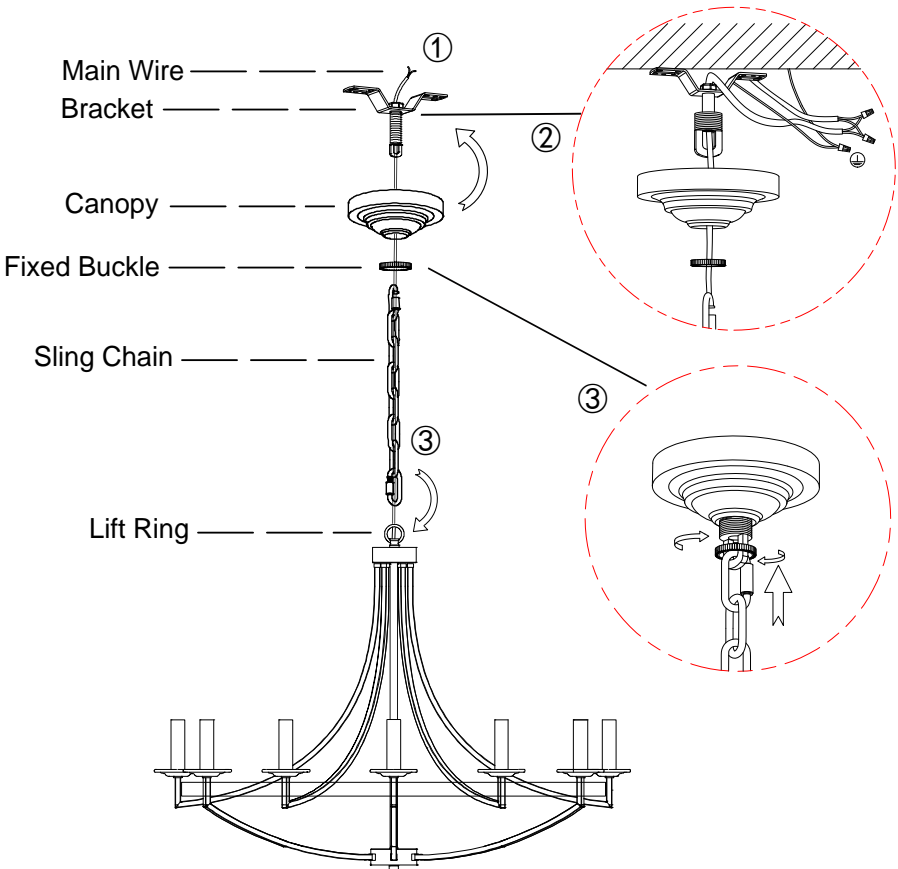

Note: Please test the fixture before installation to ensure it's working properly.

Installation Step 5 (Install the light)

6. Install the light

Install the E12 bulbs on the socket.

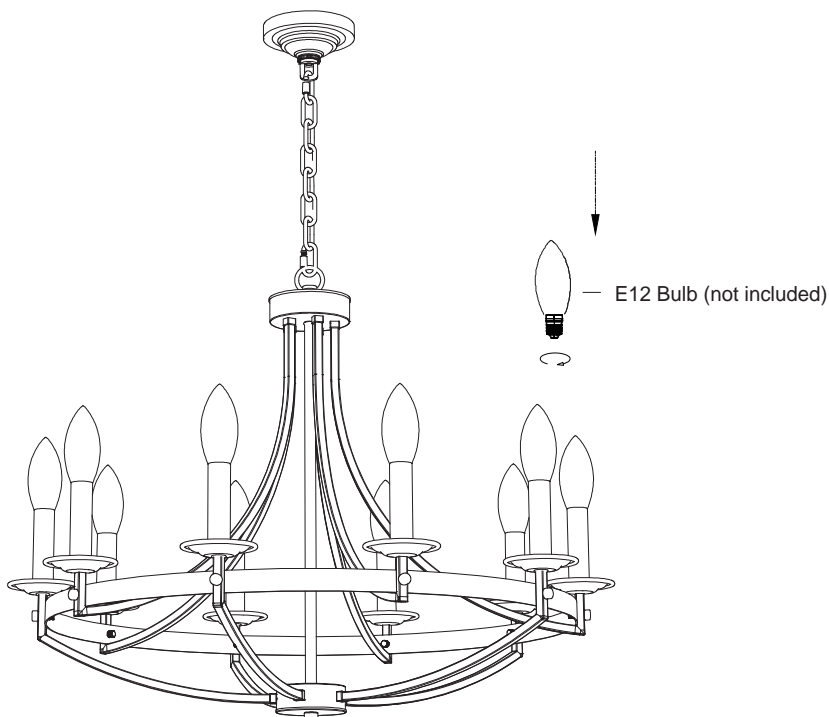

LIGHT BULBS REQUIRED

This lamp uses 10 E12 bulbs, compatible with bulb up to 40W. Fully dimmable when used with dimmable bulbs and compatible dimming switches (not included).

Trouble Shooting

1. Missing/Broken Parts

- Make a list of the missing/broken parts according to the packing list, take photos for broken parts, then email us for free replacements.

2. Bulbs Do Not Light Up

- Check your power and switch to make sure it's power on.
- Check the bulb to make sure it's installed correctly.
- Change a new bulb.
- Check the wires to make sure they are connected correctly.

3. Bulbs Flicker/Noisy Operation

- Check the bulb to make sure it's installed correctly.
- Change a new bulb.
- Make sure your bulb is dimmable if you use a dimmer switch.

4. Could Not Install/Assemble

- Take photos of the ceiling/fixture, contact seller for technical support.

Clean And Care

To clean, wipe the fixture with a soft cloth. Spraying from chemical cleaners can discolor the finish of the fixture. Do not use scouring pads, powders, steel wool, or abrasive paper to clean this fixture.

Ordering Parts

Keep this manual for future reference, and in case replacement parts are needed. Available parts can be ordered from the place of purchase. Use exact wording from diagrams when ordering parts.