

# STU8212



Product family	Dishwashers
Width	24"
Commercial height	82 cm
Installation	Fully-integrated built-in
N° baskets	2
EAN code	8017709303693



## Programs



Number of programs	5	Delicates	Yes
Washing temperatures	45, 50, 65, 70 °F	Normal	Yes
Mix	Yes	Pots & Pans	Yes
Daily (half load)	Yes		

## Options



Delay start	3-6-9 hours	Intensive washing zone option	
Extra-dry option	Yes		

## Baskets

Basket color	Gray	Lower basket	Fixed racks
Upper basket	Central fixed racks	Largest loadable dish in lower basket	35,0 inches
Upper basket height adjustment	On two height levels	Colour Inner Components	Blue
Largest loadable dish in upper basket	25,0 inches	Cutlery basket	13 place settings

## Technical Features



<b>Width</b>	23 9/16 "	<b>Tube material</b>	Stainless steel
<b>Depth</b>	21 7/16 "	<b>Filter</b>	Stainless steel
<b>Height</b>	32 3/16 "	<b>Concealed heating element</b>	Yes
<b>Rinse aid indicator</b>	Light	<b>Hinges</b>	Self-balancing with fixed hinges
<b>End-of-cycle indicator</b>	Acoustic signal	<b>Min. and max. frontal panel weight</b>	4.4 - 19.8 lbs
<b>Washing system</b>	Standard	<b>Min. and max plinth height</b>	4" - 9"
<b>Third spray arm</b>	Single	<b>Adjustable feet</b>	2 3/4", from 32 1/4" to 35"
<b>Flood protection system</b>	Single Aquastop	<b>Additional gaskets</b>	Yes
<b>Max water hardness</b>	100°FH;58°dH	<b>Back cover</b>	Yes
<b>Drying system</b>	Natural condensation drying		

## Electrical Connection

<b>Plug</b>	(A) USA & Mexico	<b>Frequency (Hz)</b>	60 Hz
<b>Connected power</b>	1800 W	<b>Connection type</b>	Single-phase
<b>Current</b>	13 A	<b>Power supply cable length</b>	140 "
<b>Voltage</b>	115 V		

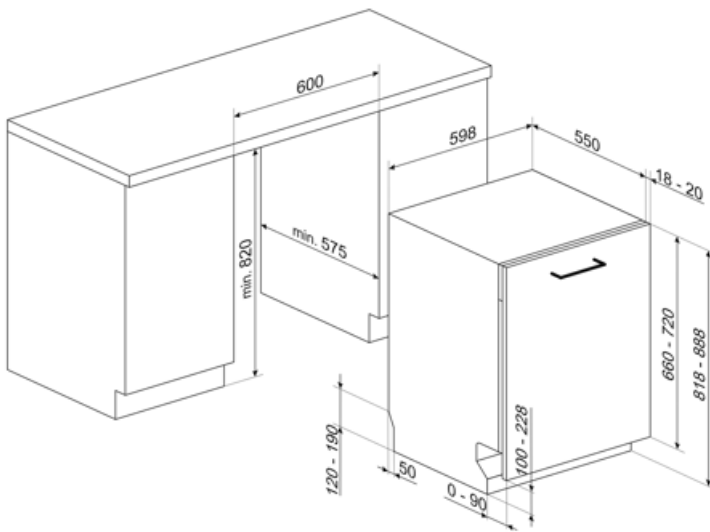

## Compatible Accessories



### KIT6CX

Classic aesthetics stainless steel panel with 14 mm. handle. Can be fitted on the fully integrated dishwashers.



### KIT82CAN

Classic aesthetics anthracite panel with 14 mm. handle. Can be fitted on the fully integrated dishwashers.



### KIT82CX



### KITPL60FABB

Toekick Kit in White colour with adjustable height. Can be fitted over all the fully integrated and underbench models with Fixed Fulcrum. Can be installed also on the models with variable fulcrum or flexifit hinges.



### KITPL60FABN

Toekick Kit in Black colour with adjustable height. Can be fitted over all the fully integrated and underbench models with Fixed Fulcrum. Can be installed also on the models with variable fulcrum or flexifit hinges.



### KITPL60FABX











Toekick Kit in Stainless Steel with adjustable height. Can be fitted over all the fully integrated and underbench models with Fixed Fulcrum. Can be installed also on the models with variable fulcrum or flexifit hinges.



### KITPLV2

Kit extension for dishwasher and washing machine: length mt. 2

## Symbols glossary

	<p>Acquastop: Some Smeg dishwashers are equipped with a simple Acquastop: float sensor in the bottom which is necessary to prevent an accidental leakage of water inside the appliance.</p>		<p>COMM_HEIGHT_82_72dpi</p>
	<p>Delay Timer: The delay timer can postpone the start of the program by up to 24 hours.</p>		<p>Noise Level: Excellent insulation and special devices keep noise to a minimum.</p>
	<p>...</p>		<p>1/2 load: This program is designed for washing dishes not heavily soiled with partial load of the dishwasher.</p>
	<p>Delicate: Delicate washing program is designed for delicate dishes which are not heavily soiled.</p>		<p>Normal programme: The normal programme is suitable for normal degrees of dirt for everyday use.</p>
	<p>The symbols show the number of plate settings of the dishwasher.</p>		<p>System WaterSave ensures the best washing results with minimal water consumption depending on the model of dishwasher.</p>