

# 6\*8 Storage Shed Installation\_16208GR

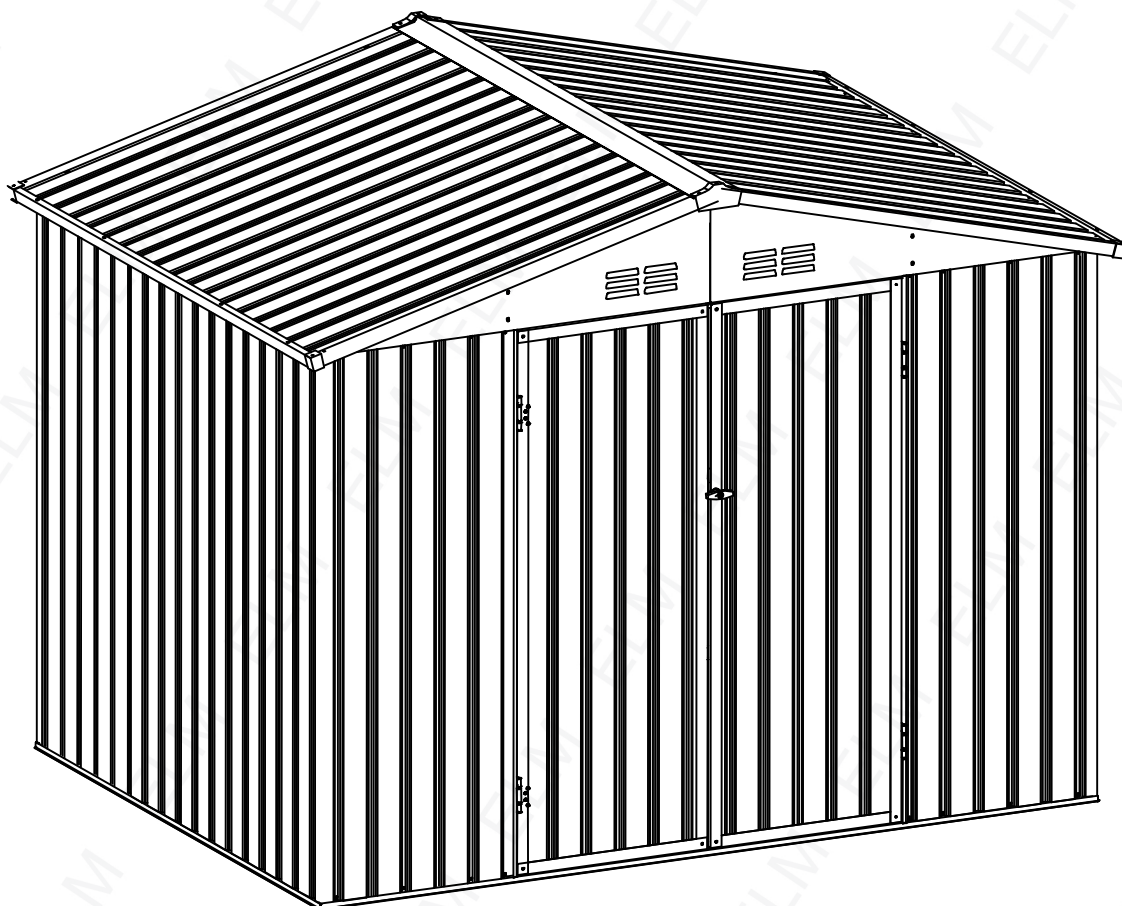

**The product comes in two packages.  
Please install after receiving all packages.**

**Please prepare below tools before installation. (Not Included)**

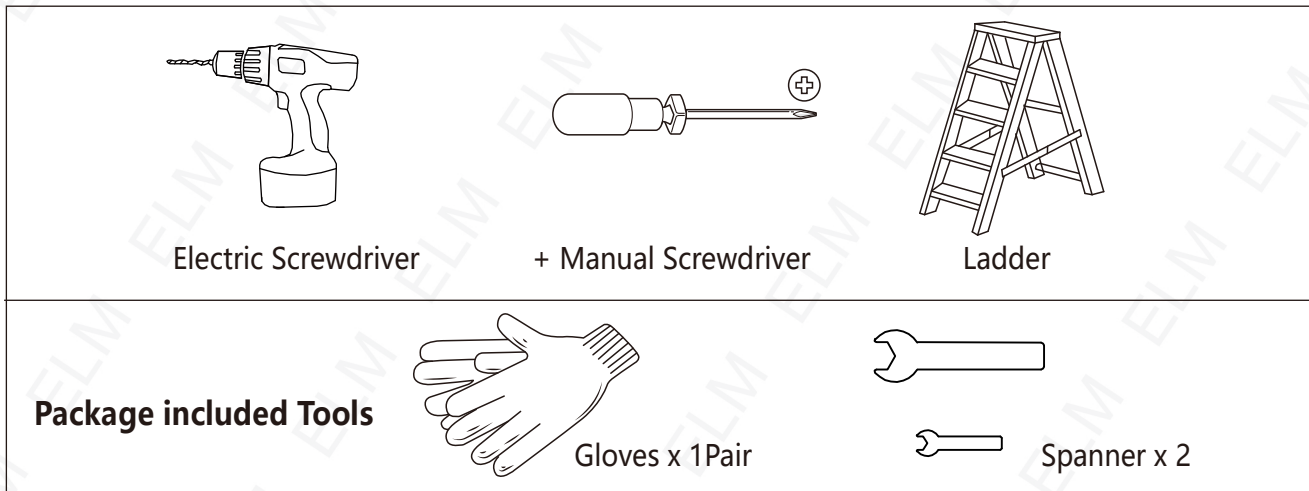

**ATTENTION:**

Please read this instruction carefully before installation and follow it strictly during installation. Ensure that there are no problems later due to installation errors.

**Installation Notes**

Please check the quantity of all parts before installation (Please refer to the Parts Lists) and the appearance of the products. Please make sure the product is correct before installation. If there is any problem, please contact us directly.

Make sure the colored panels are facing outwards and all the holes match. The panels are textured, please install the panels in the order specified in the instructions. All lines and holes must be accurately matched to make the storage shed more stable. Please ensure that all screws are tightened to prevent the product from falling apart.

There is a protective film on the surface to protect the product, please tear it off after installation to get the final presentation. If you do not damage the film during installation, it can also remain on the product to protect the product.

Please place the product on a flat ground to prevent leaning and collapse. If the ground is uneven, the door may can't be closed.

**⚠ Safety Precautions**

We recommend two adults to complete the installation. Two adults installed together will make the installation process easier and safer.

The gloves must be carried to prevent hand cuts during installation.







Take care when using power tools near water the use of a residual current device (RCD) is advised.

Please use the electric driver carefully during screwing to prevent the screw from slipping and hurting your hand. (We recommend that beginners use a manual screwdriver for installation. )



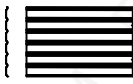

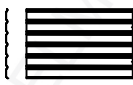
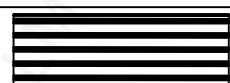

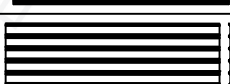



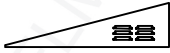

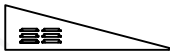



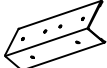





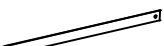

Be careful not to fall when installing the roof. Please steady the ladder and make sure the product placed on a flat ground.

**PLEASE KEEP THIS INSTRUCTION FOR FUTURE REFERENCE.**













## Package A\_Part List

PART	NO.	QTY.		PART	NO.	QTY.
	WD6A-S-L	1			W6A-S	2
	WD6A-S-R	1			PW7A-S-M	2
	W6A-S-D	2			PW7A-S-L	2
	WS7A-S	4			PW7A-S-R	2
	W7A-S	4				

## Package B\_Part List

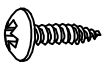
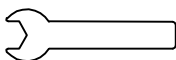
PART	NO.	QTY.		PART	NO.	QTY.
	A3	2			M11	2
	A4	2			M2	4
	BE1	1			C3	4
	BE1R	1			C4	4
	BE2	1			DA	2
	BE2R	1			DLA	1
	BS3	2			DRA	1
	UE1	2			DGA	2
	UE1L	2			DDA	2
	US3	2			DBA	4
	UA	2			GC	4
	M9	1			GE	2
	M10	4			T-F	4

## Package B\_Part List

PART	NO.	QTY.		PART	NO.	QTY.
	F1	258			C2	4
	F2	23			DH	4
	F3	32			GL	1
	V2	244			SL	44
	F4	4			M20	1
	DC	2			M4	1
					ST	1

## Part List

Shed top panels

NO.	QTY.
PW7A-S-L	2
PW7A-S-M	2
PW7A-S-R	2
M10	4
M11	2
M9	1
GE	2
GC	4

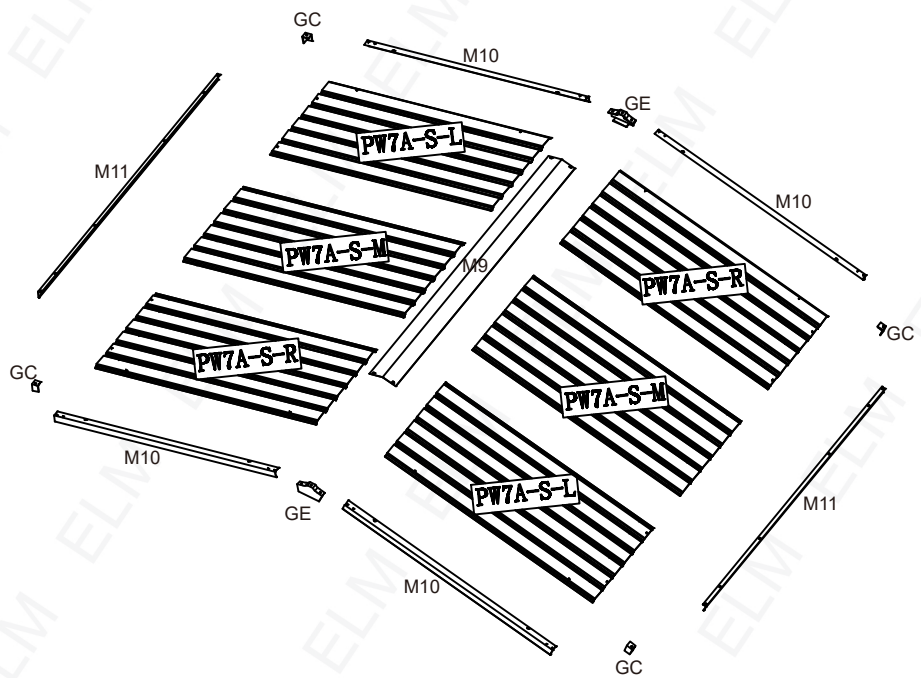

# Part List

## Shed top frame

NO.	QTY.
A4	2
A3	2
C4	4
C3	4
C2	4
UE1	2
UE1L	2
M2	4
US3	2

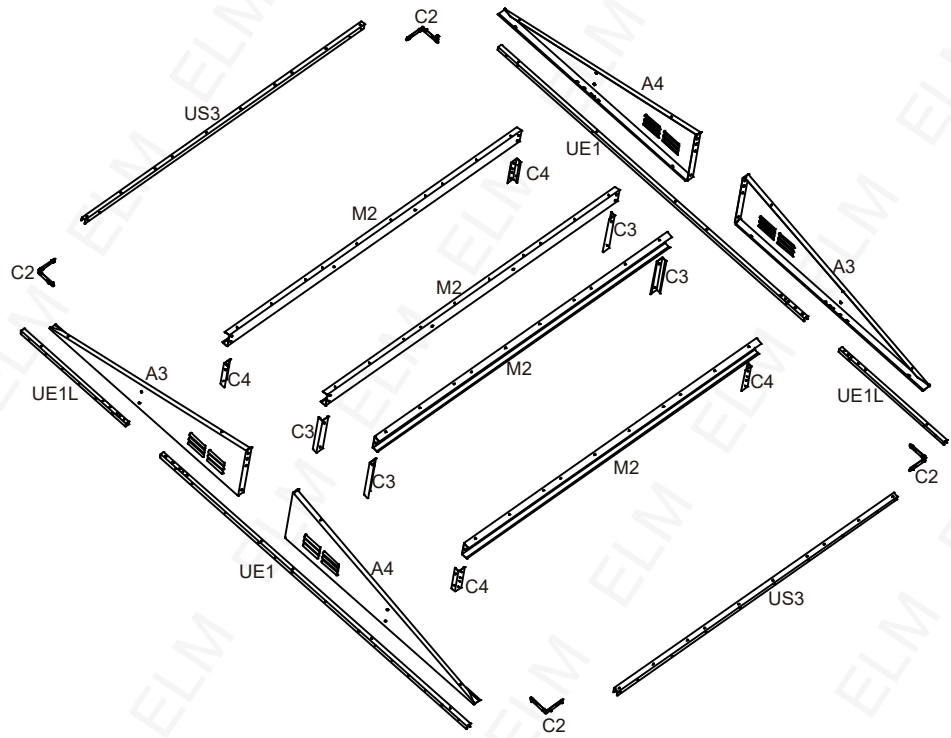

Door	
NO.	QTY.
WD6A-S-L	1
WD6A-S-R	1
DLA	1
DRA	1
DA	2
DGA	2
DDA	2
DBA	4
DC	2
DH	4
GL	1

## Shed base frame

NO.	QTY.
BE1	1
BE2	1
BE1R	1
BE2R	1
T-F	4
BS3	2

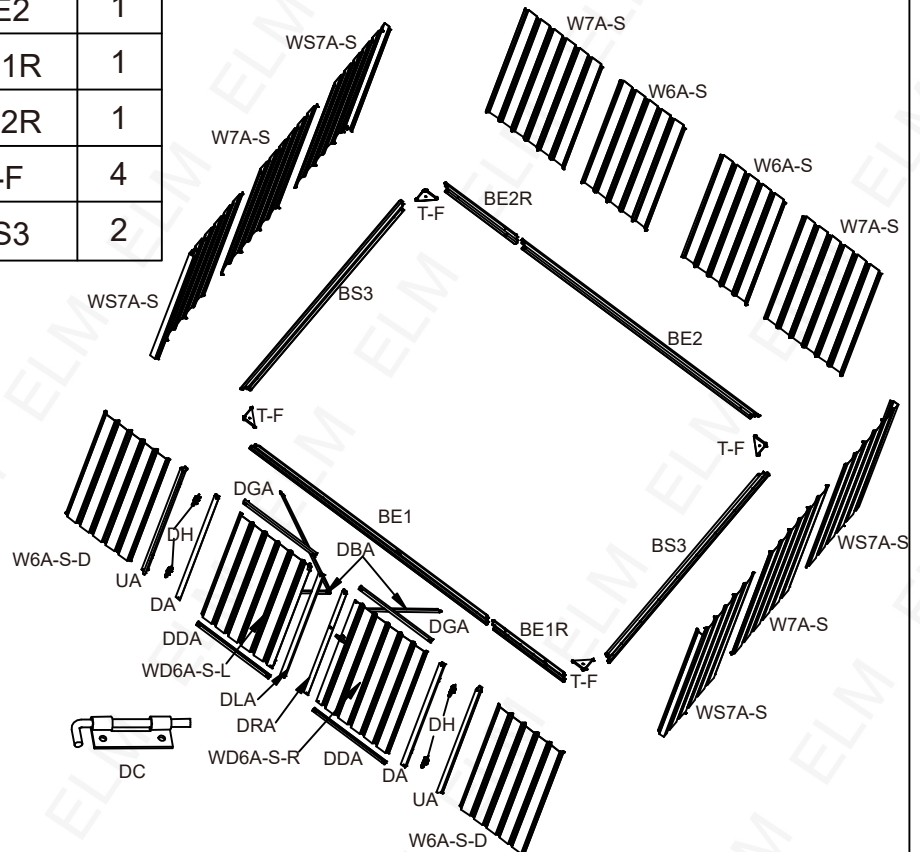

## Shed side panels

NO.	QTY.
WS7A-S	4
W7A-S	4
W6A-S-D	2
W6A-S	2
UA	2

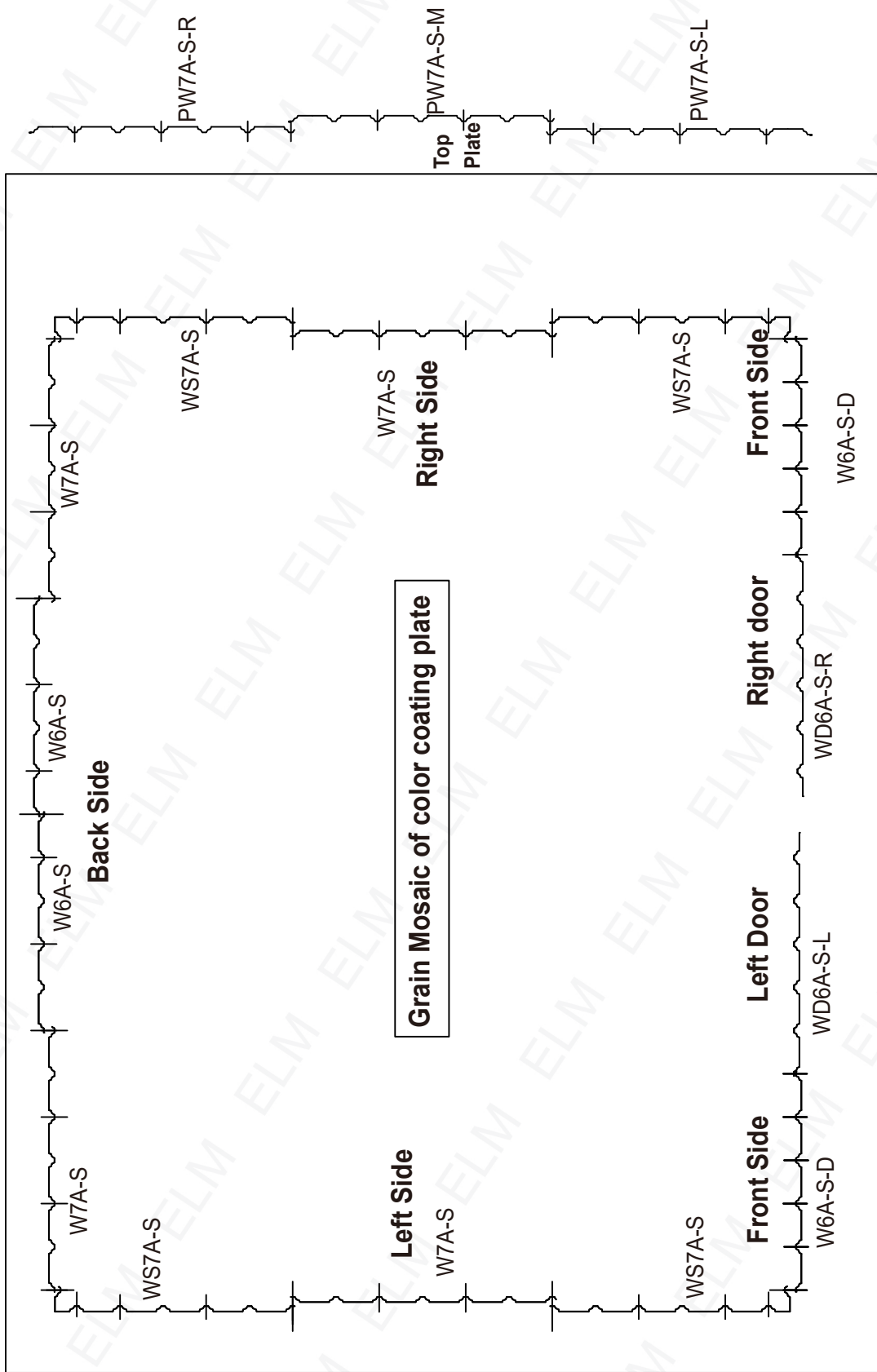

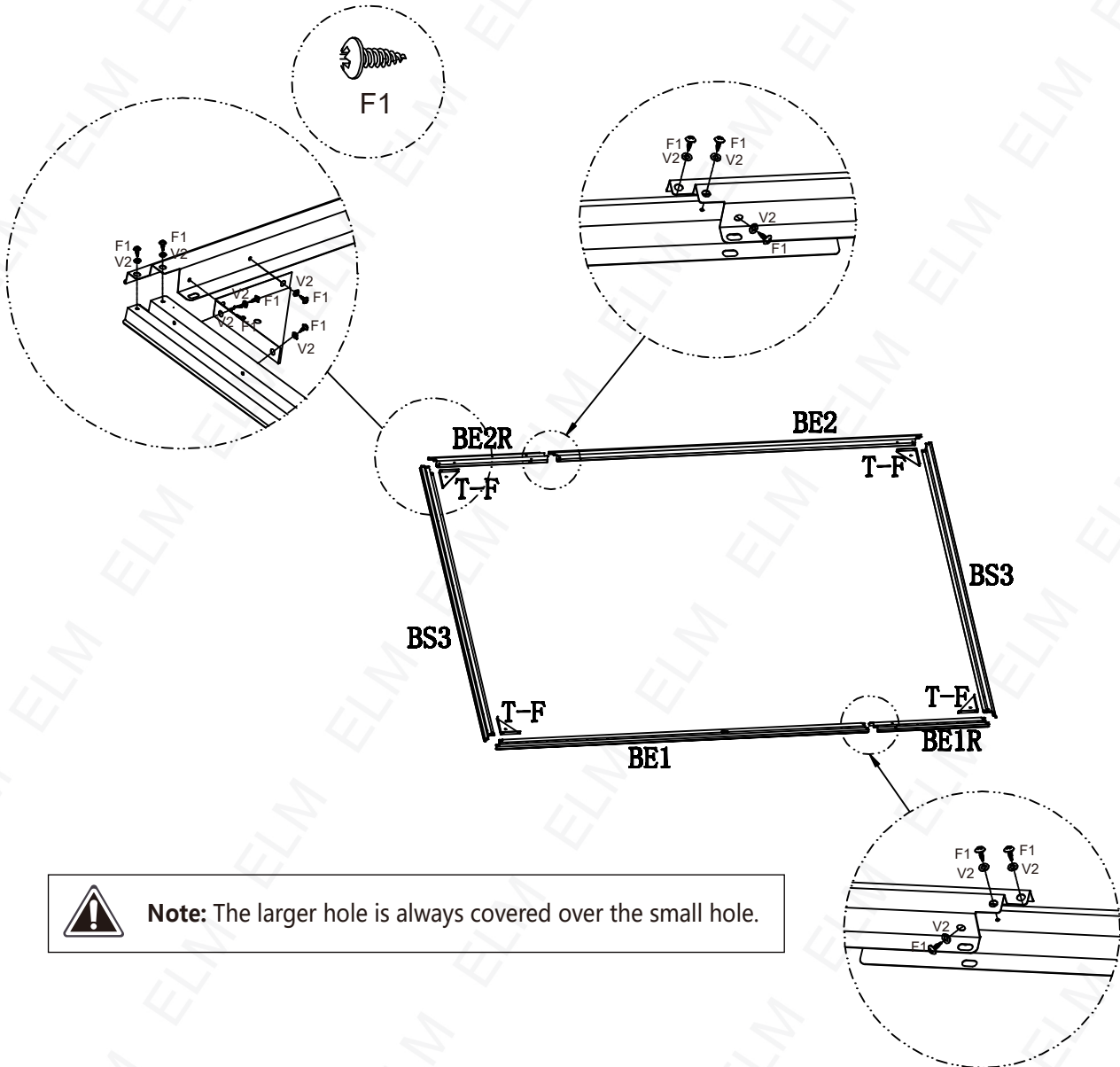

# Shed Base Frame Assemble

PART	NO.	QTY.	PART	NO.	QTY.
	BE1	1		BS3	2
	BE1R	1		T-F	4
	BE2	1		V2	30
	BE2R	1		F1	30







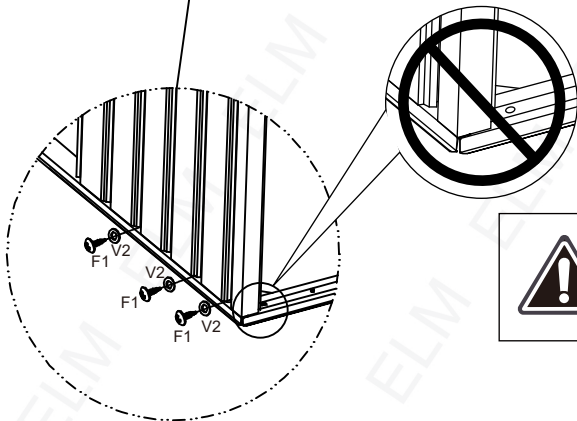
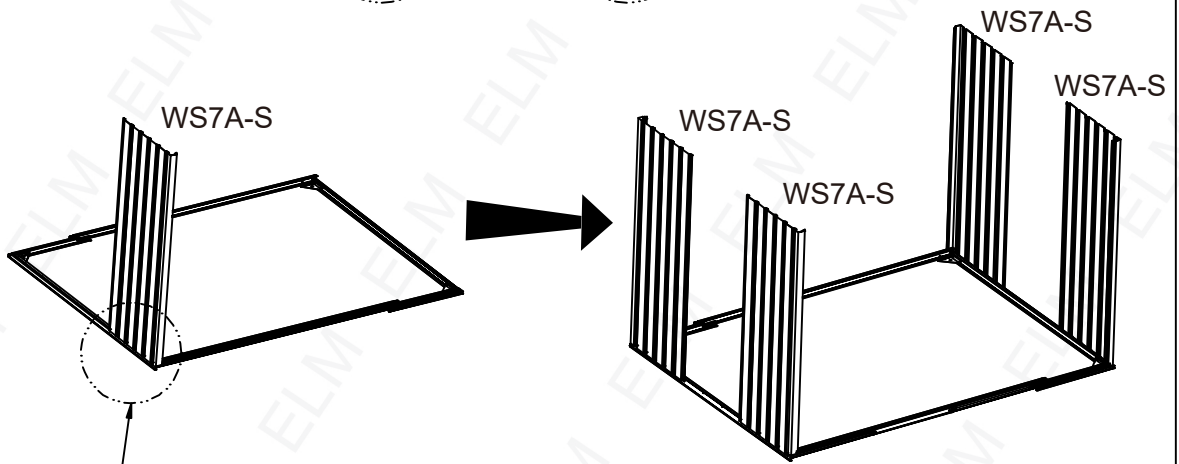
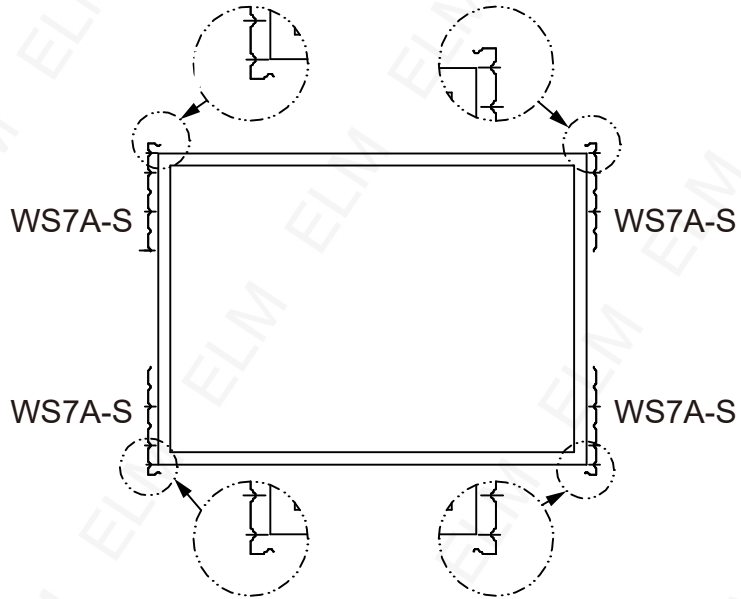

# Shed Side Panels Assemble

PART	NO.	QTY.	PART	NO.	QTY.
	WS7A-S	4		V2	12
				F1	12







Please do not install the screw here. They will be installed after the other plates are installed.  
(Please refer to page 11)

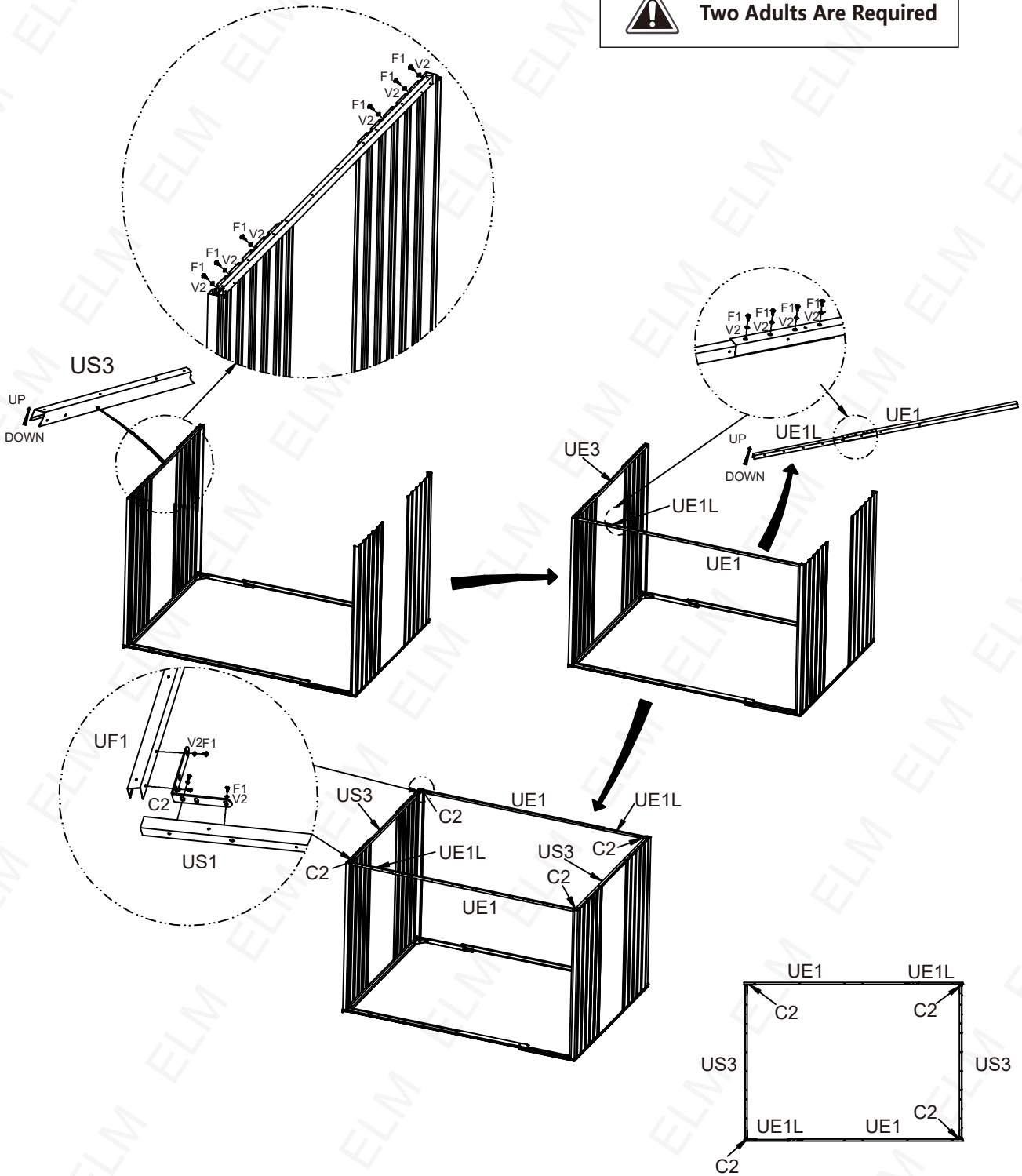



PART	NO.	QTY.	PART	NO.	QTY.
	UE1	2		F1	36
	UE1L	2		V2	36
	US3	2		C2	4

 **Two Adults Are Required**

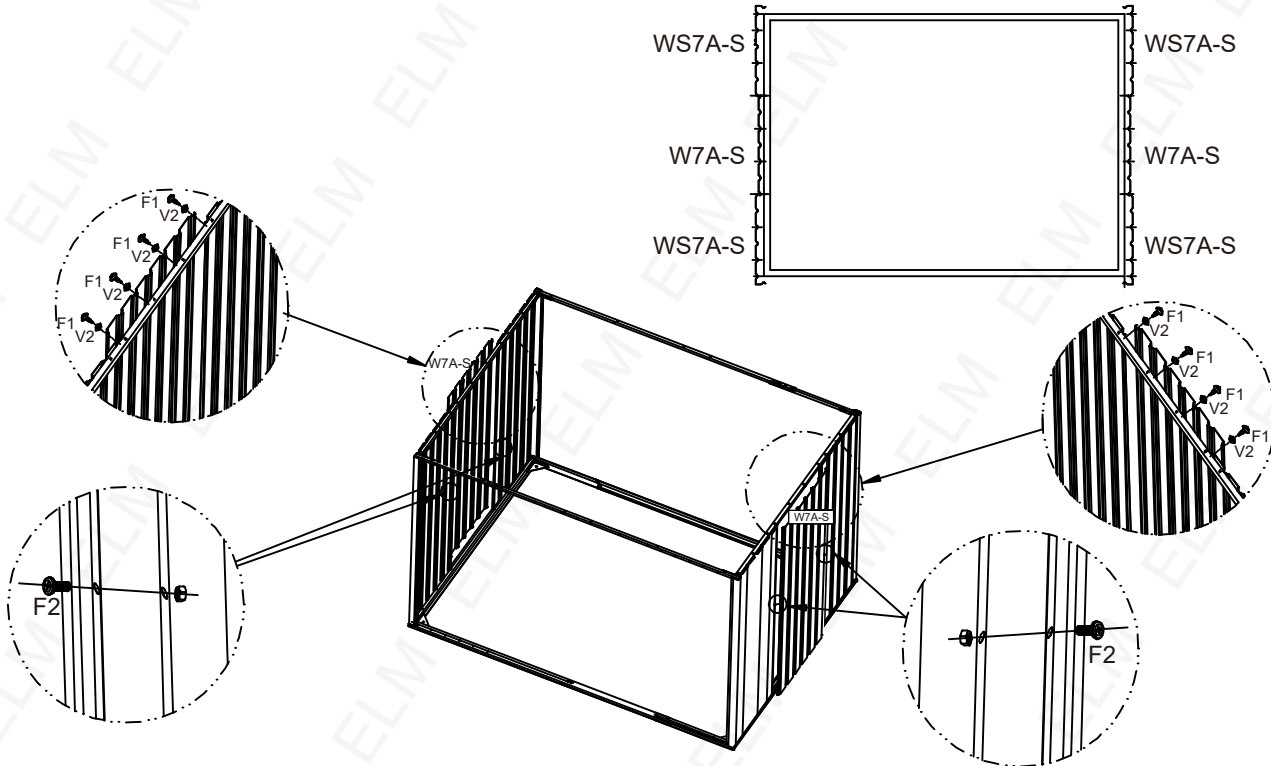

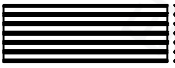



PART	NO.	QTY.	PART	NO.	QTY.
	W7A-S	2		F1	16
	V2	16		F2	4

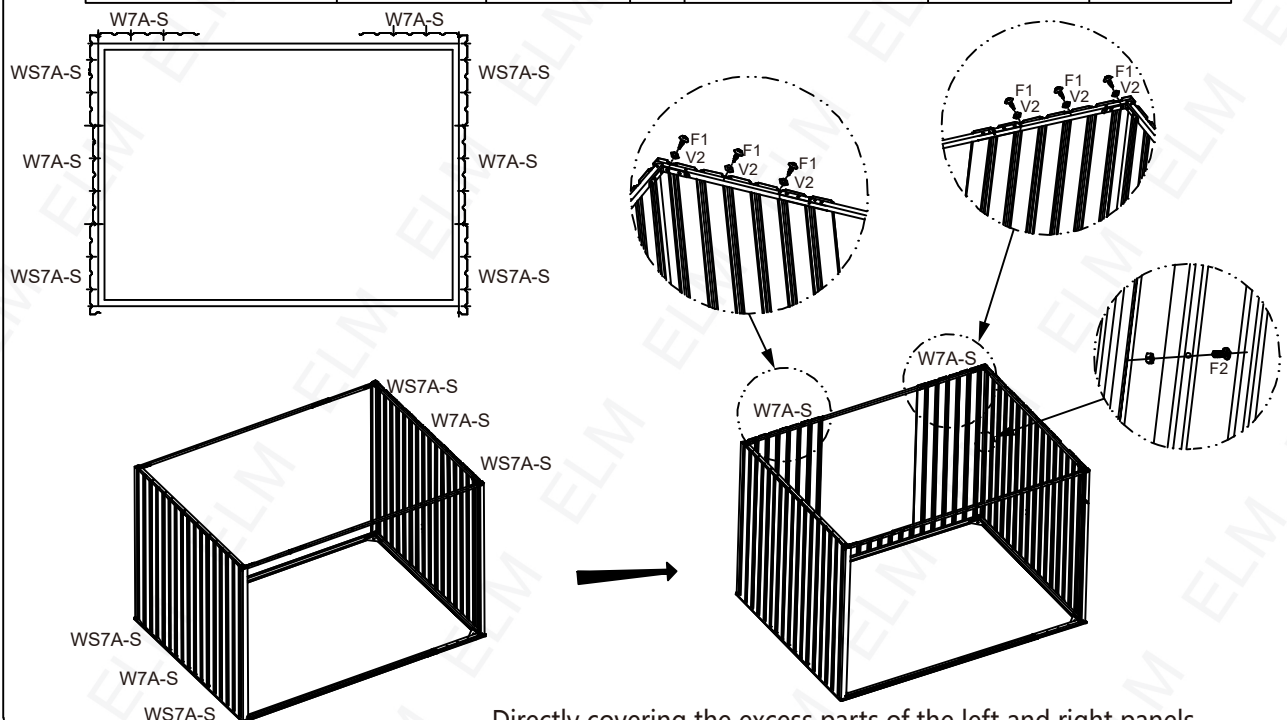







PART	NO.	QTY.	PART	NO.	QTY.
	W7A-S	2		F1	12
	V2	12		F2	2

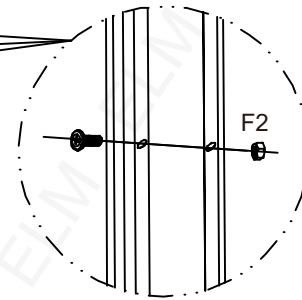
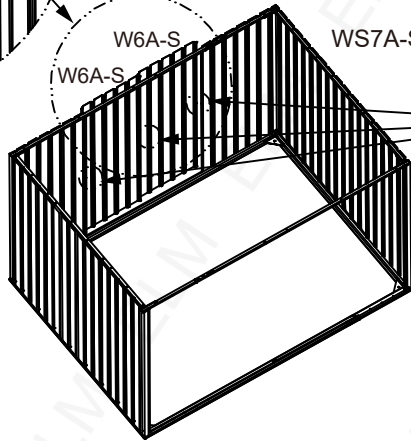
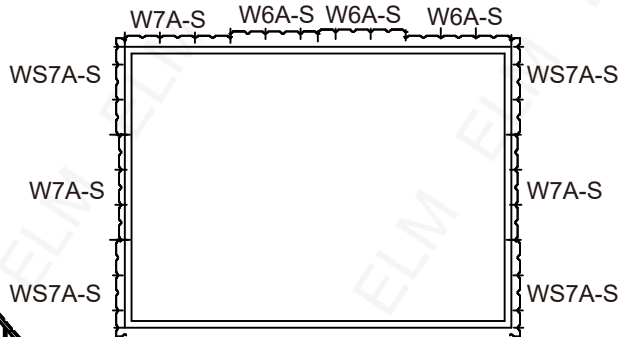
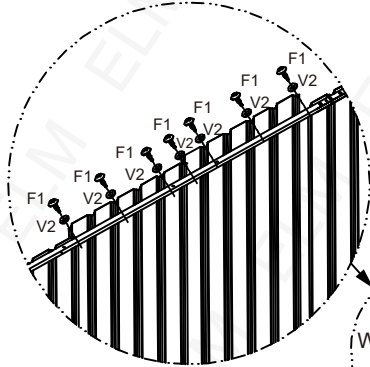

Directly covering the excess parts of the left and right panels.

PART	NO.	QTY.	PART	NO.	QTY.
	W6A-S	2		F1	14
	V2	14		F2	3







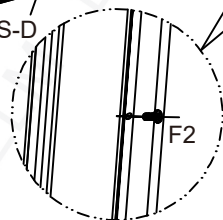
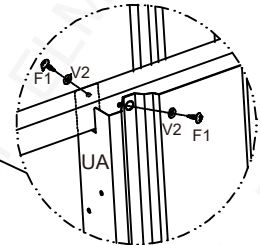
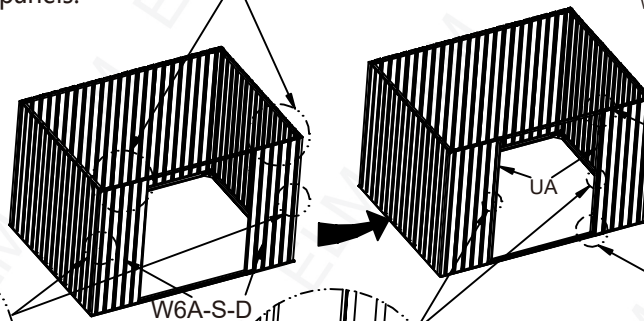
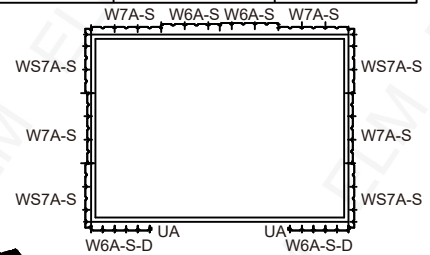

PART	NO.	QTY.	PART	NO.	QTY.
	W6A-S-D	2		F1	28
	UA	2		F2	4
	V2	28			



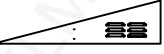

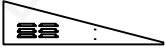

Directly covering the excess parts of the left and right panels.

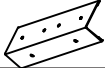

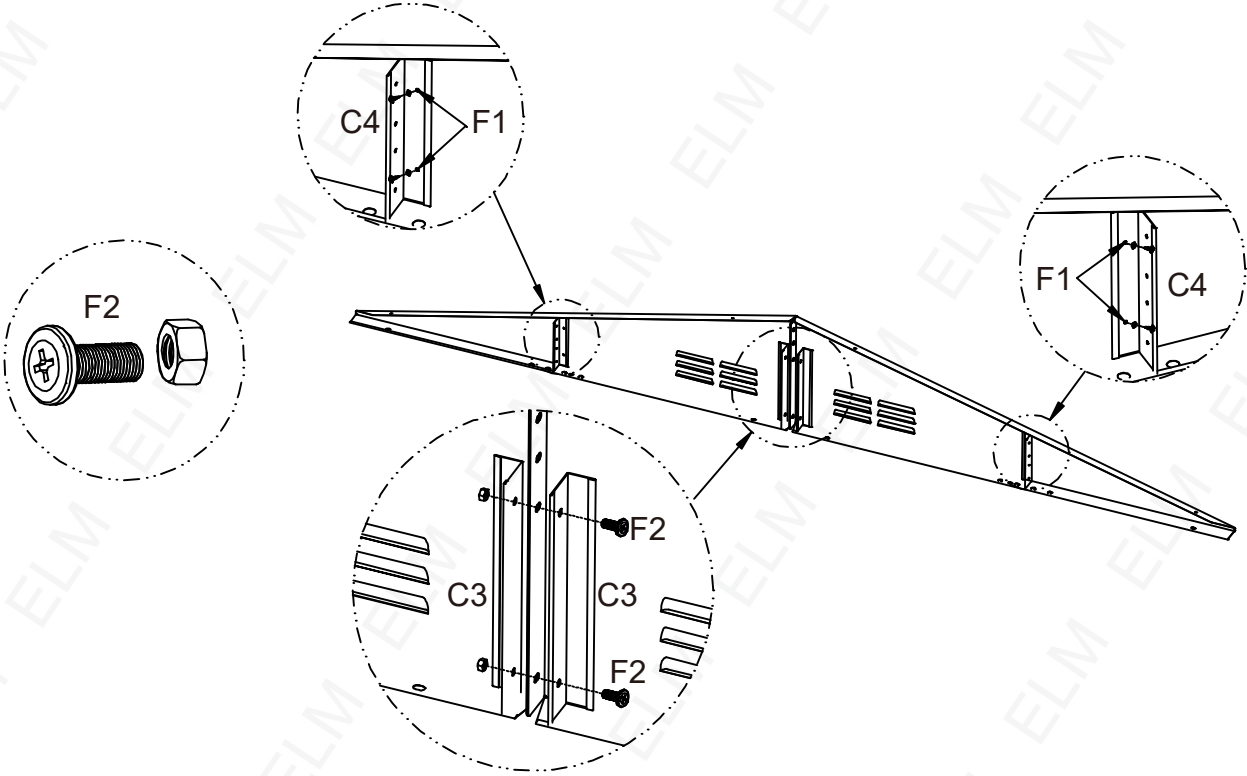
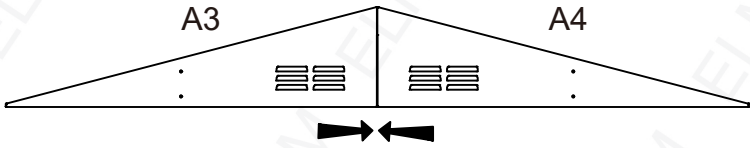

# Shed Top Frame Assemble



PART	NO.	QTY.	PART	NO.	QTY.
	A3	2		F2	4
	A4	2		V2	8
	C3	4		F1	8
	C4	4			

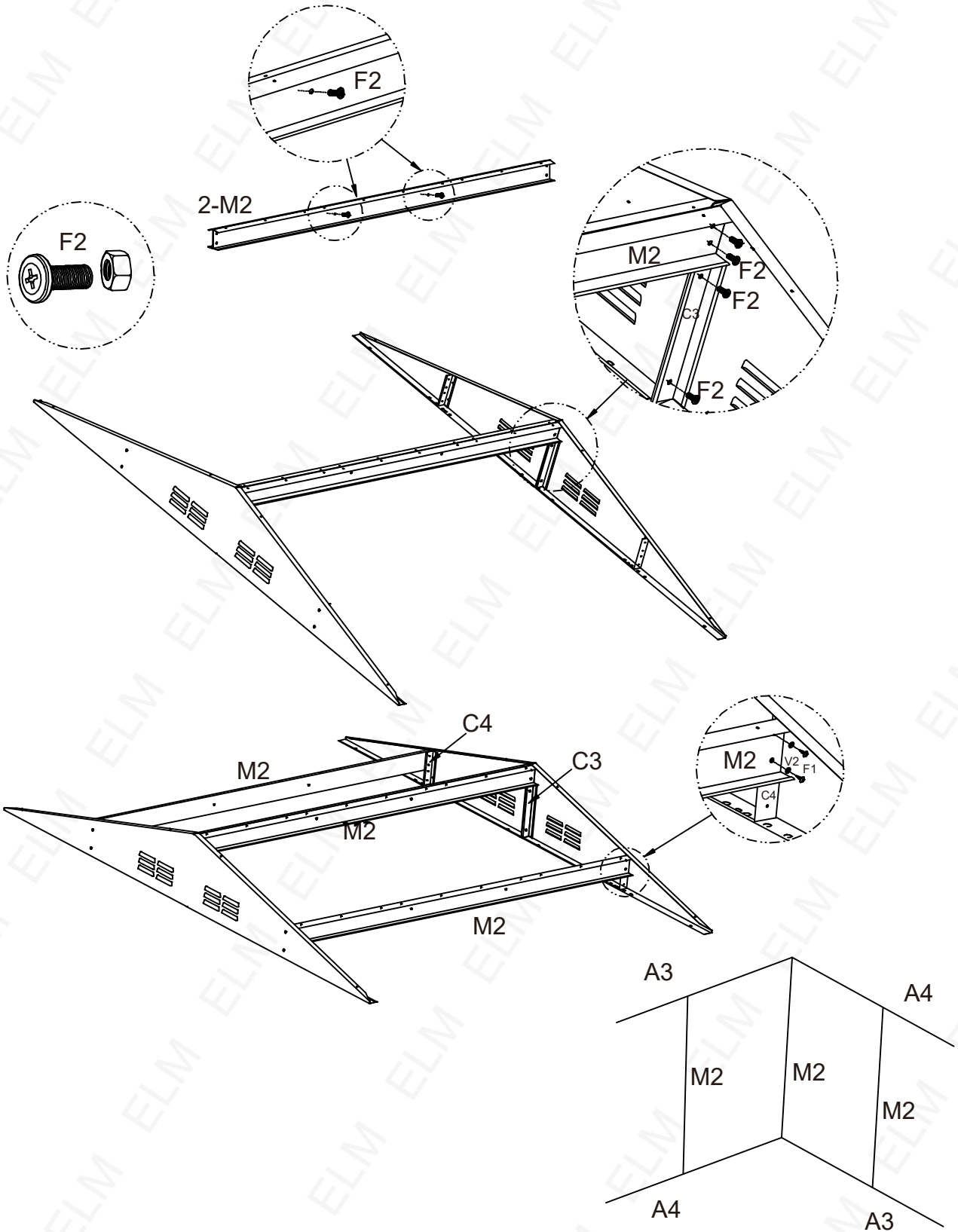

PART	NO.	QTY.	PART	NO.	QTY.
	M2	4		F1	8
	V2	8		F2	6





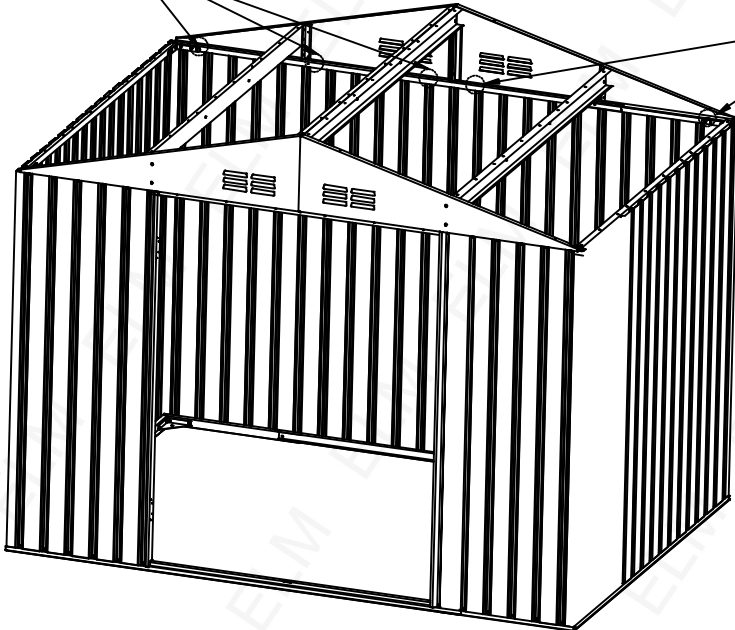
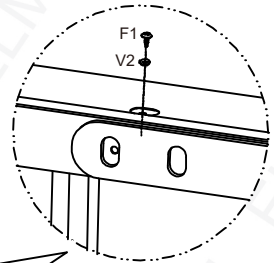
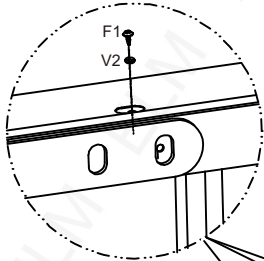
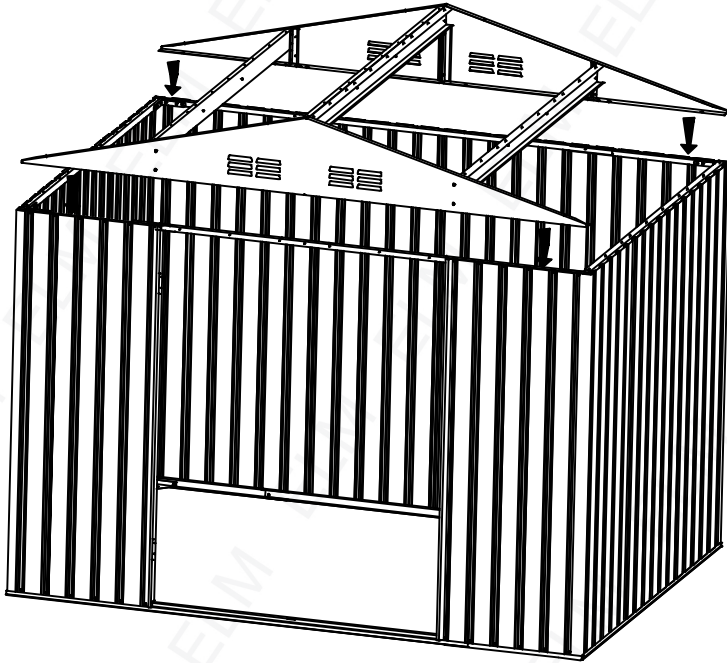

 **Two Adults Are Required**

PART	NO.	QTY.
	F1	12
	V2	12

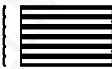

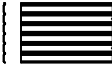

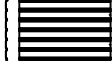



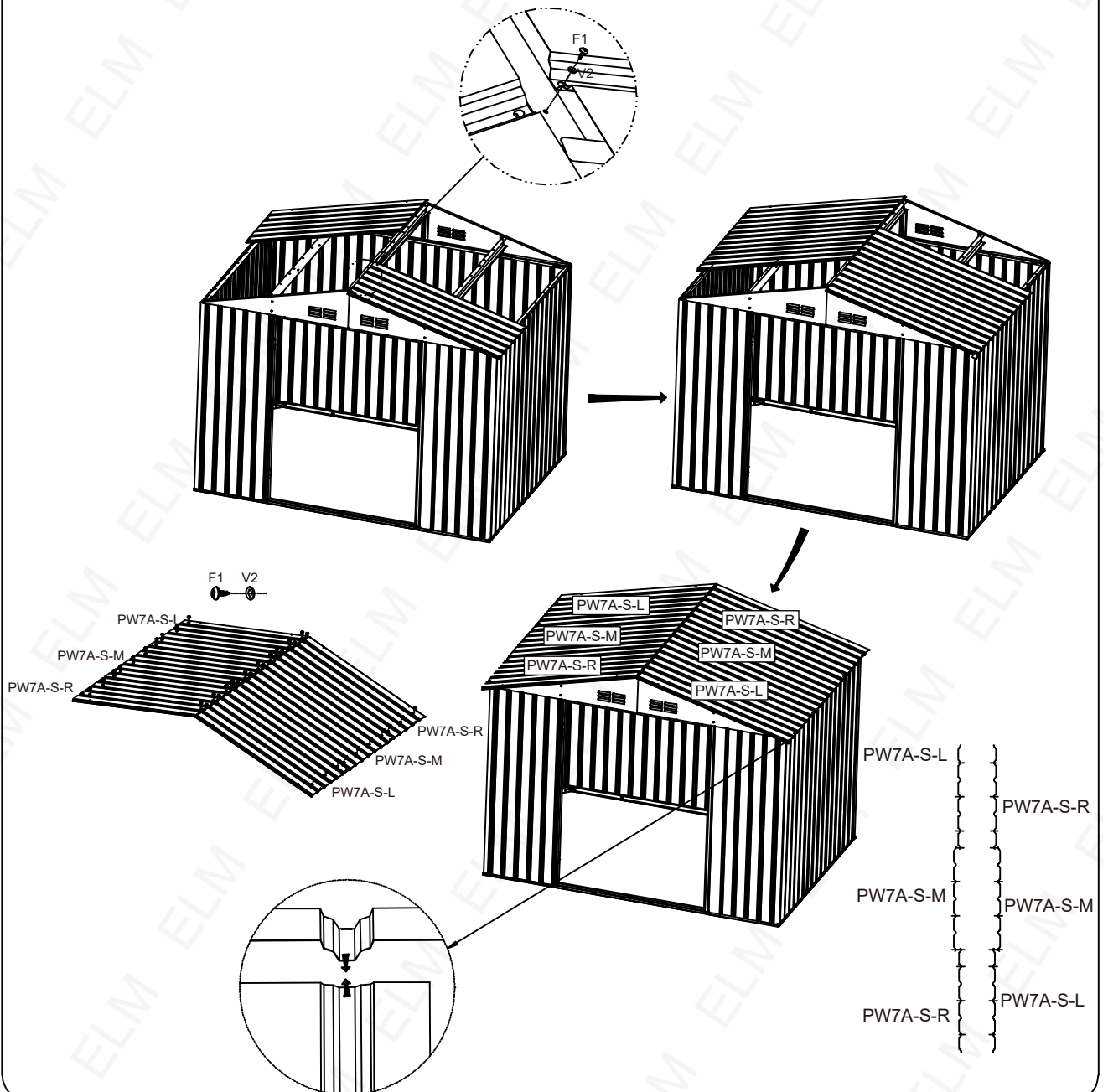

# Shed Top Panels Assemble

PART	NO.	QTY.	PART	NO.	QTY.
	PW7A-S-M	2		F1	40
	PW7A-S-L	2		F2	40
	PW7A-S-R	2			







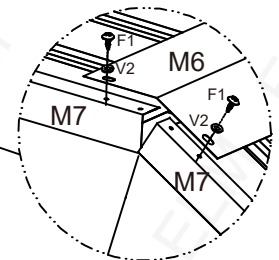
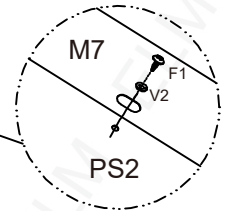
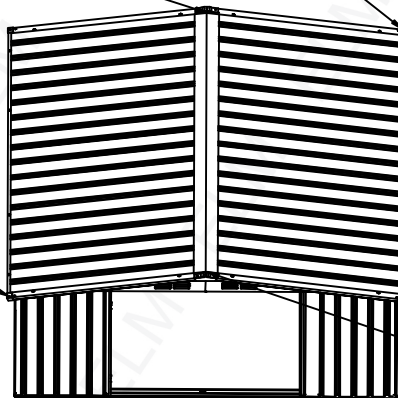
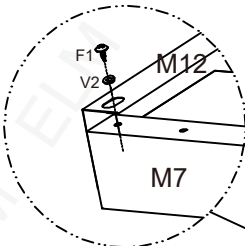
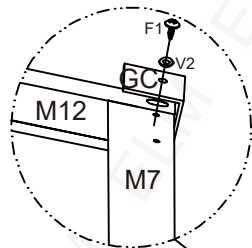
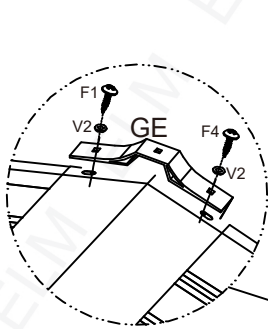
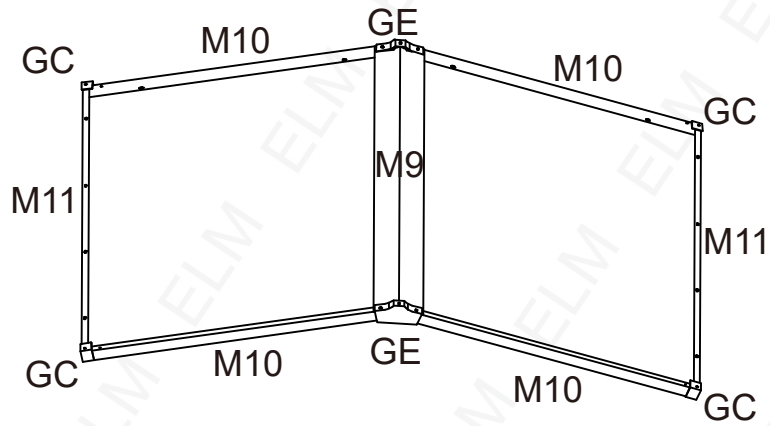

Please steady the ladder make sure the product placed on a flat ground.



PART	NO.	QTY.	PART	NO.	QTY.
	M9	1		GE	2
	M10	4		F1	20
	M11	2		V2	24
	GC	4		F4	4



# Door Assemble

PART	NO.	QTY.
	DA	1
	DLA	1
	DGA	1
	DDA	1
	DBA	2
	WD6A-S-L	1
	F1	9

## DL



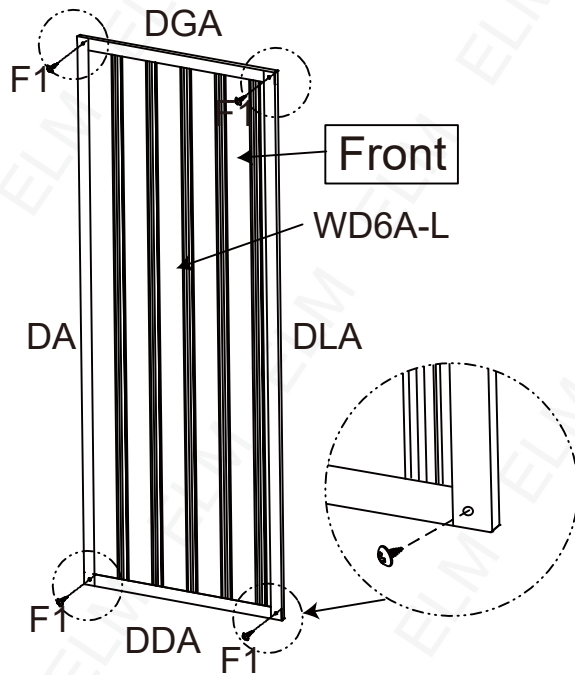

View from the front, the vertical rod covers the horizontal rod. The larger hole is always covered over the small hole.

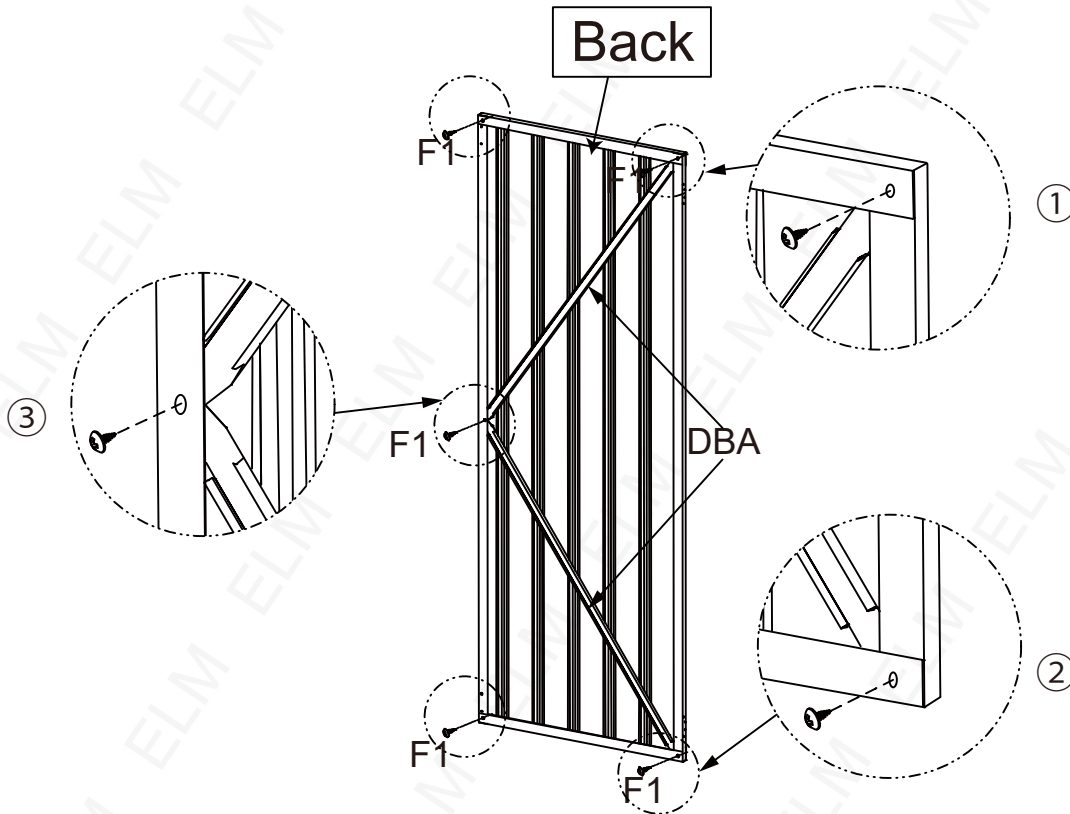

Please follow the steps ①-②-③ to install.

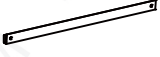
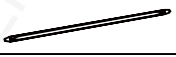

The final fixation should be done after all parts are aligned.

PART	NO.	QTY.
	DA	1
	DRA	1
	DGA	1
	DDA	1
	DBA	2
	WD6A-S-R	1
	F1	9

## DR

View from the front, the vertical rod covers the horizontal rod.  
The larger hole is always covered over the small hole.

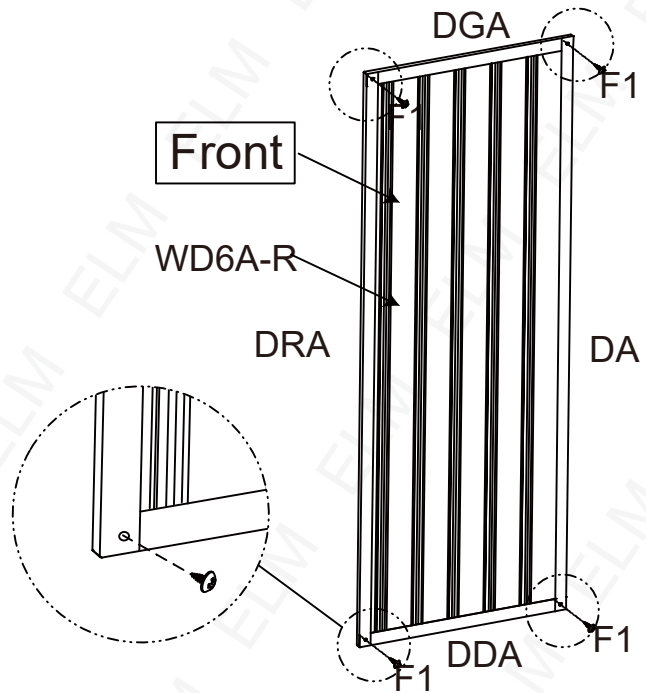



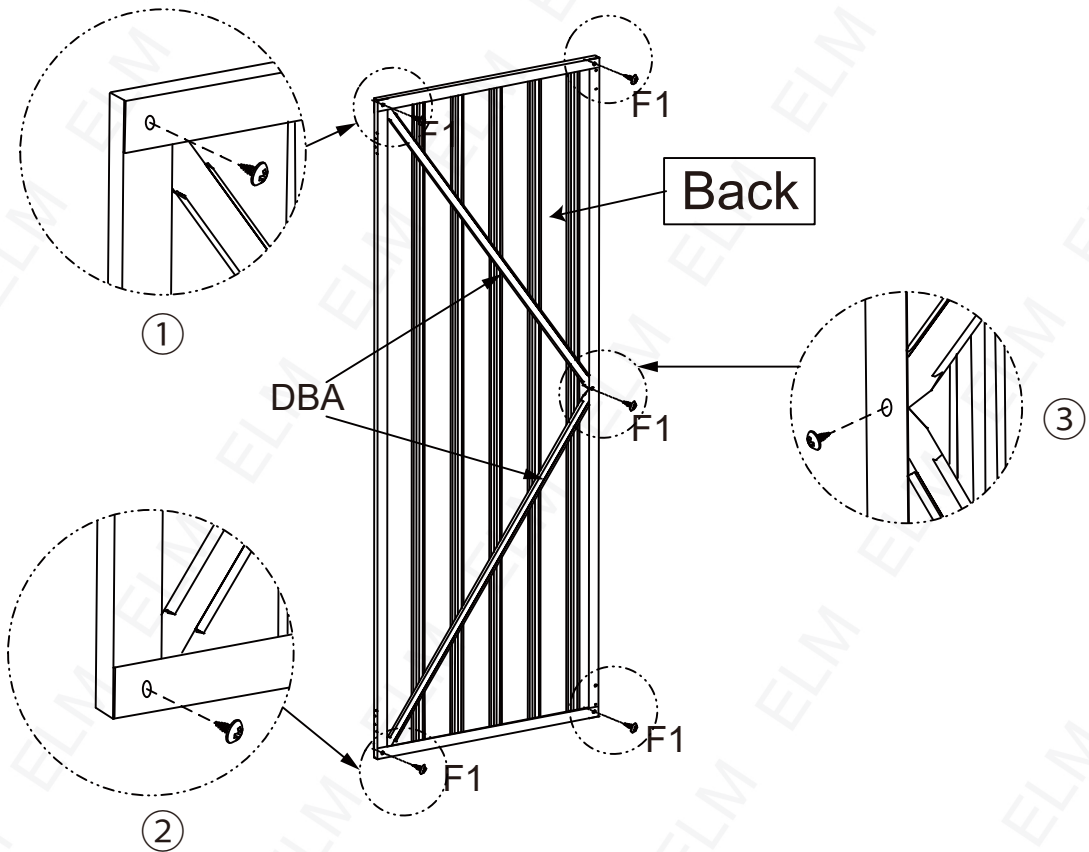





Please follow the steps ①-②-③ to install.

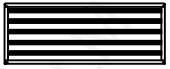

The final fixation should be done after all parts are aligned.

# DL

The left and right is seen from the outside.

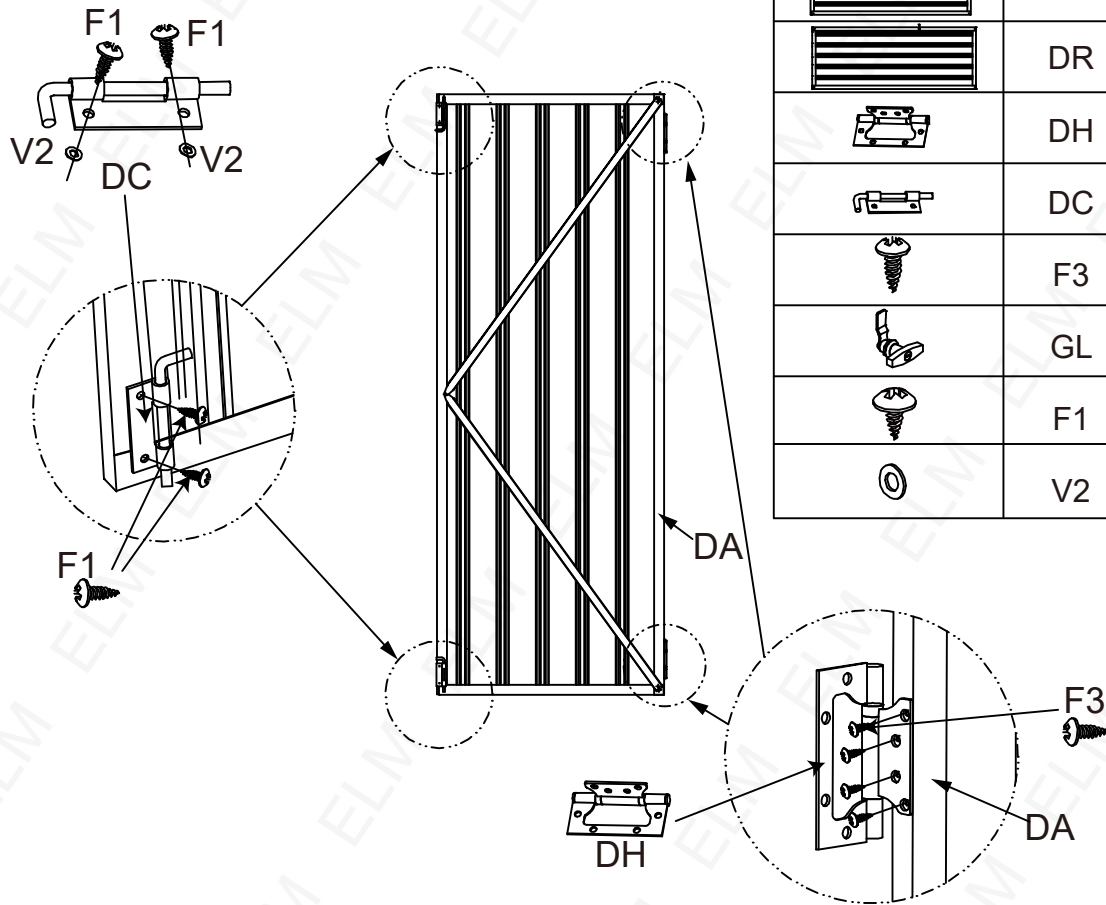

PART	NO.	QTY.
	DL	1
	DR	1
	DH	4
	DC	2
	F3	16
	GL	1
	F1	4
	V2	4



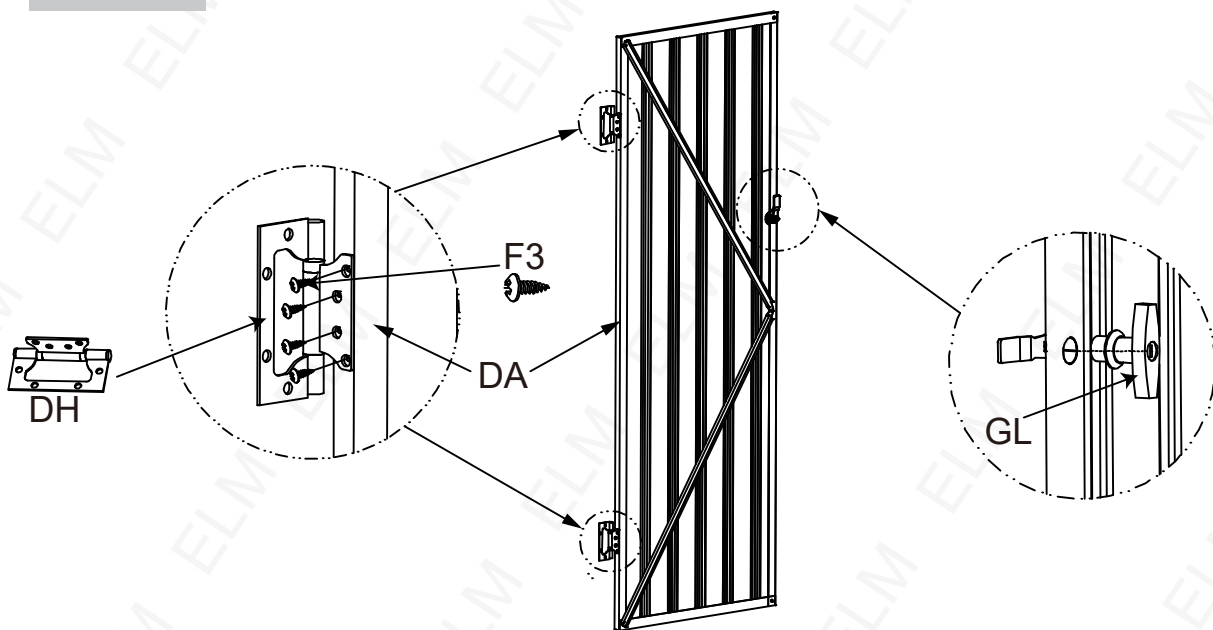

# DR

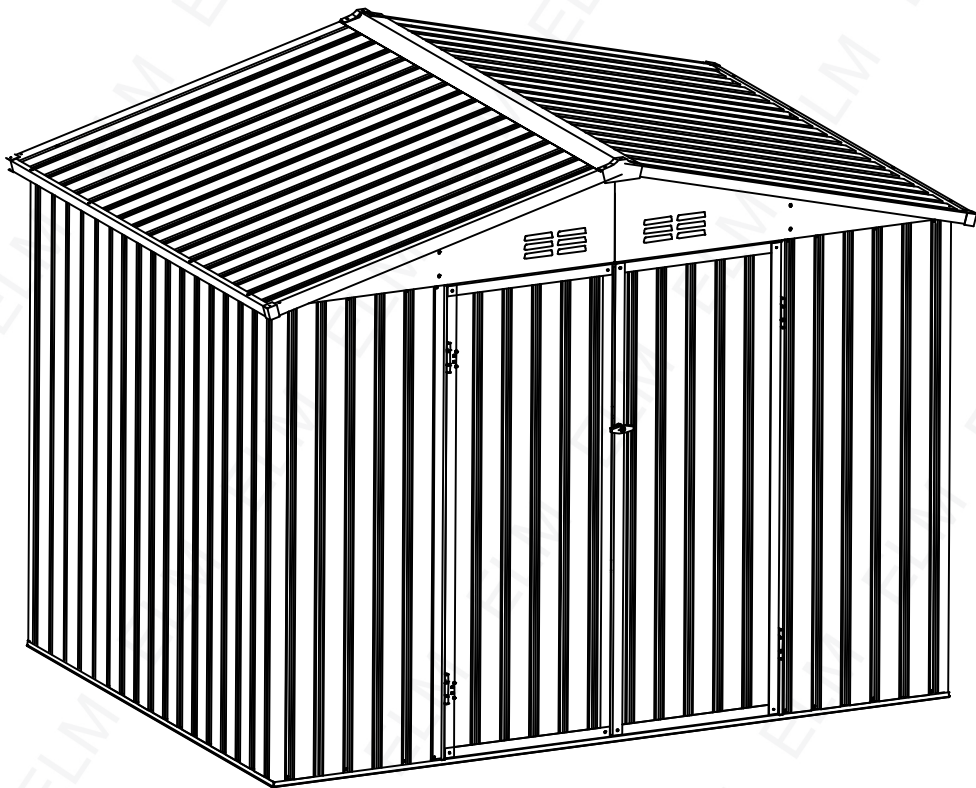
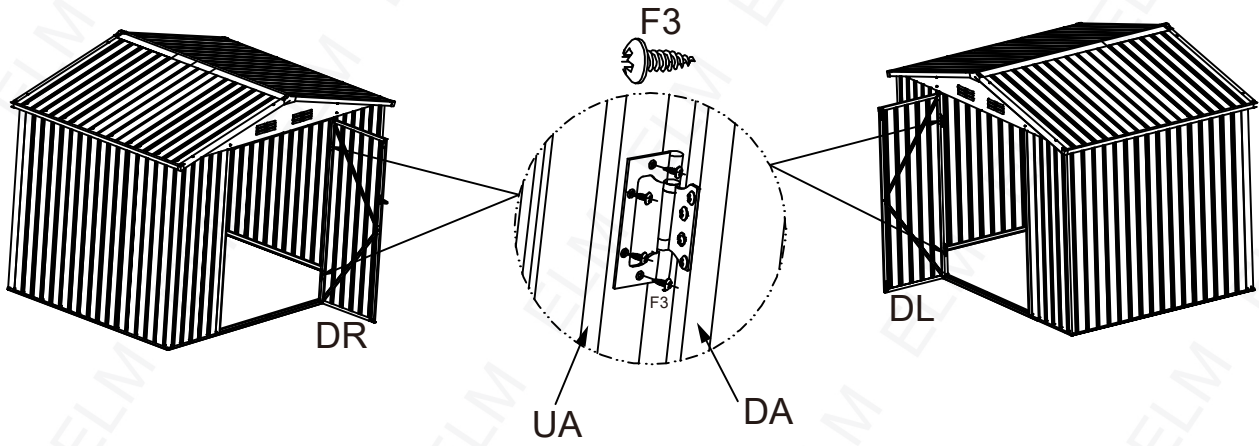

The large piece needs to be installed on UA. (Wall side)

PART	NO.	QTY.
	DL	1
	DR	1
	F3	16



PART	NO.	QTY.
	SL	44

The exposed parts of the screw need to be covered with a plastic protective cap.

Crew position: Upper beam support rod CH.

Upper beam M2.

Ceiling connecting rod M10 and M11.

