







Assembly Instructions



36 " ROUND SOLID FIXED TOP PEDESTAL TABLE

Thank you for purchasing this quality product. Be sure to check all packaging material carefully for small parts that may have come loose inside the carton during shipment.

COMPONENT LIST:

FIGURE	DESCRIPTION	QTY
	Hardware Bag	1 pce
	Table Top	1 pce
	Pedestal Stand	1 pce
	Pedestal Leg	4 pcs
	Mounting Plate	1 pce
	Levelers	4 pcs

HARDWARE LIST:

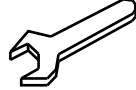
PART NO	FIGURE	DESCRIPTION	QTY
1		Hex Nut	12 pcs
2		Lock Washer	12 pcs
3		Flat Washer	12 pcs
4		Wrench	1 pce

This product will take 15-20 minutes to assemble.

Reminders

1. Use only the hardware supplied.
2. Once the product is assembled, level and tighten all the bolts.
3. Do not over-tighten bolts.
4. This item may require periodic tightening

NOTE:

1. Two or two people are needed for assembly
2. Please keep all hardware parts out of the reach of children.

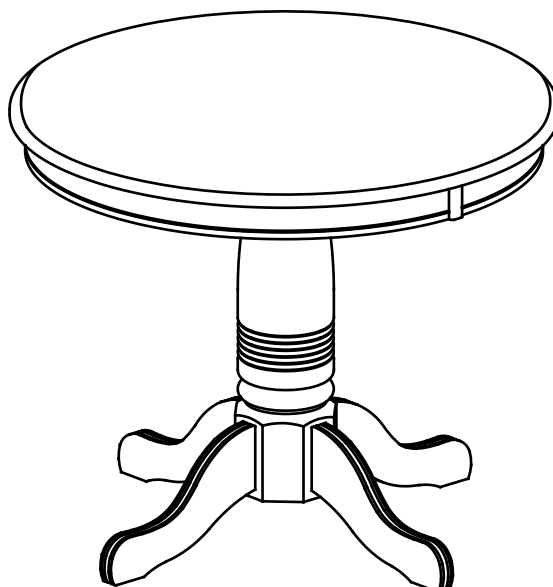

Assembly Instructions

36 " ROUND SOLID FIXED TOP PEDESTAL TABLE

ASSEMBLY :

STEP 1

- 1.1-Turn the Pedestal Stand upside down on a soft protective surface. Attach Leg by inserting pedestal leg through per-drilled holes on pedestal.
- 1.2-Use **Flat Washer(3)**, **Lock Washer(2)**, **Hex Nuts (1)** and **Wrench(4)** to attached the pedestal Leg to the pedestal stand.
- 1.3-Repeat step 1.2 For the remaining pedestal legs Leg, once all pedestal leg been attached, turn the base assembly right side up.

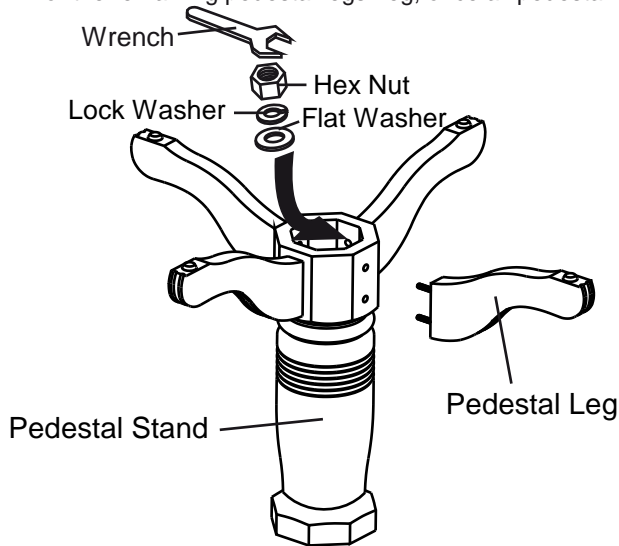

STEP 2

- 2.1-Align and attach the table top to the base Assembly by inserting **Flat Washer(3)**, **Lock Washer(2)** and **Hex Nut (1)**, tighten all nuts using **Wrench(4)** provided.

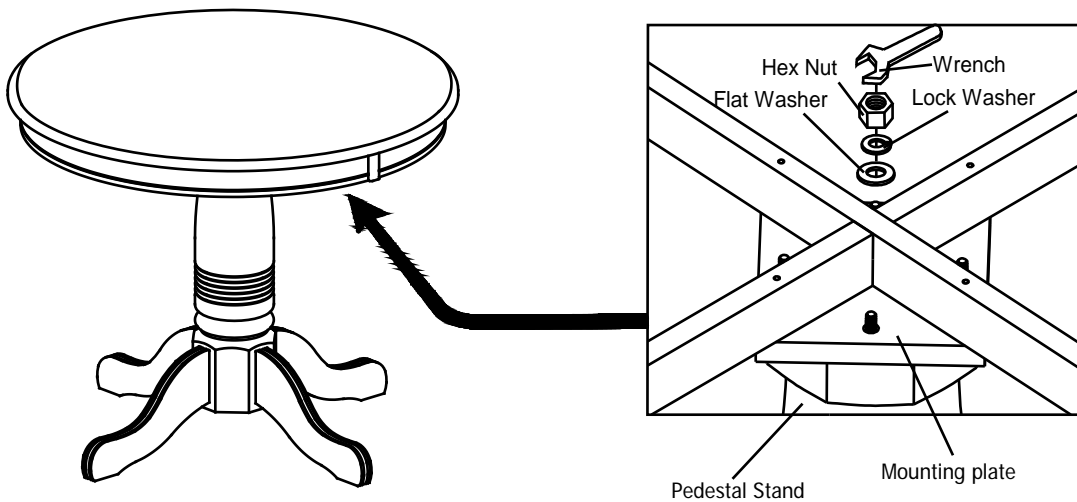

STEP 3

- 3.1- Adjust the levelers until the table sits firmly.

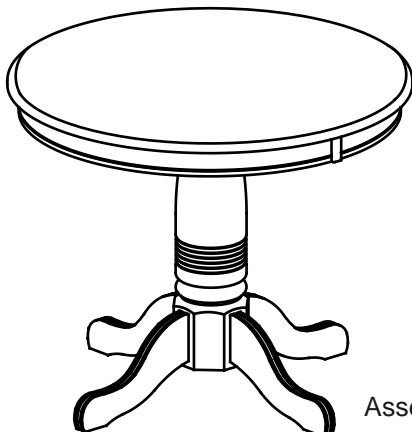

Assembly is now completed.

CARE INSTRUCTION

- ~ Be sure to use the same type of polish consistently. Your furniture will appear cloudy or streaky if oil based or wax based polishes are interchanged.
- ~ Spray your furniture surface evenly. Wipe in a circular motion with a soft clean cloth.