

ASSEMBLY INSTRUCTION

PARTS LIST

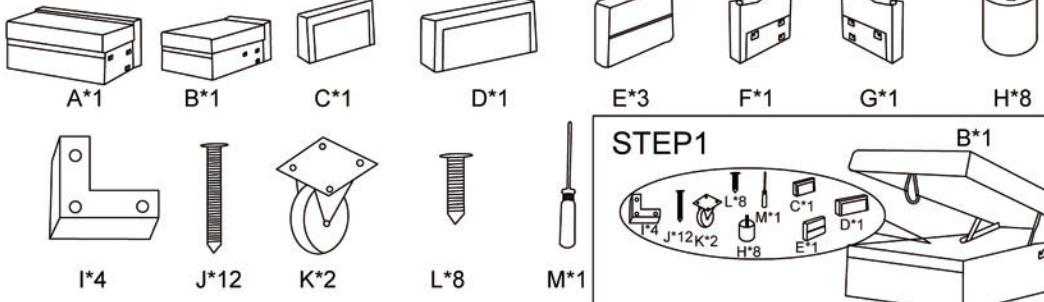

STEP 1

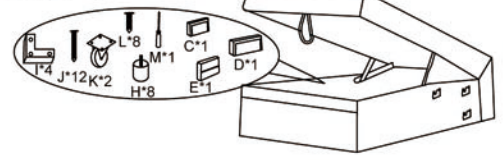

STEP 2

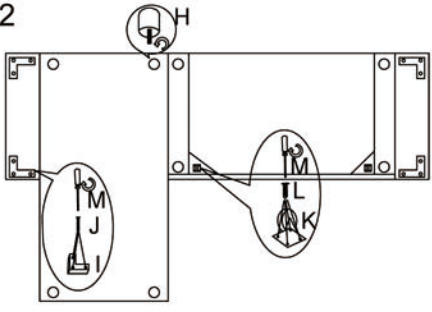

STEP 3

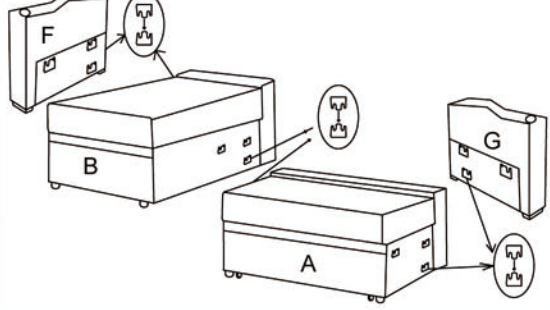

STEP 4

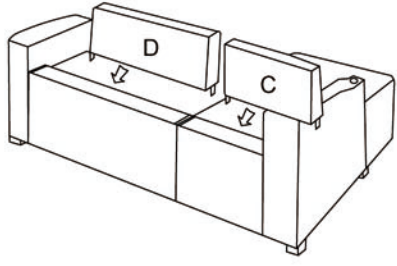

STEP 5

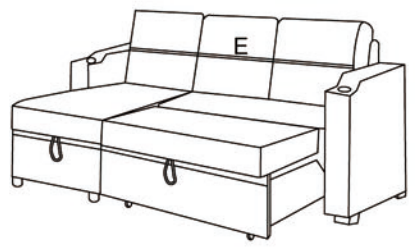

FUNCTION:

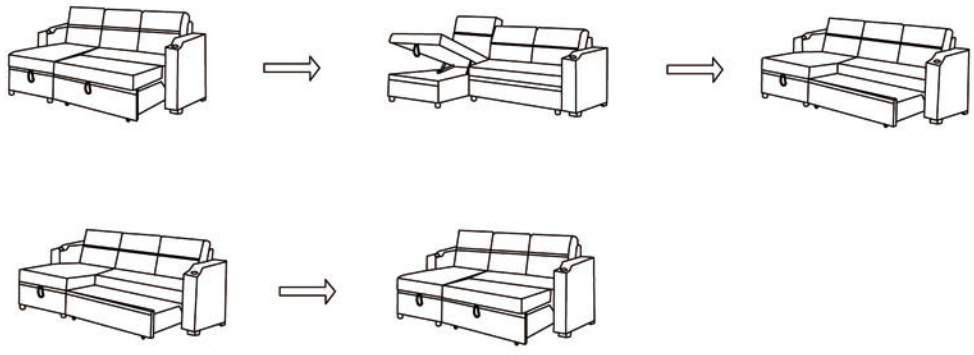

ASSEMBLY INSTRUCTION

PARTS LIST



A*1



B*1



C*1

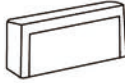

D*1



E*3



F*1



G*1



H*8

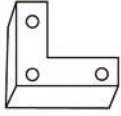

I*4



J*12

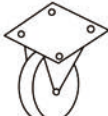

K*2



L*8



M*1

STEP 1

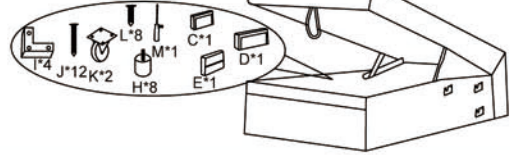

STEP 2

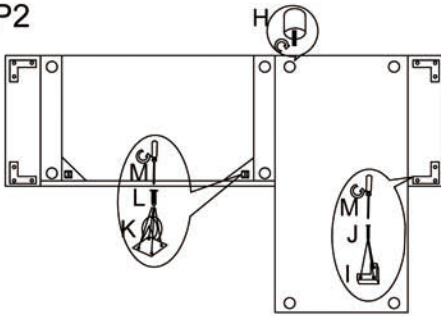

STEP 3

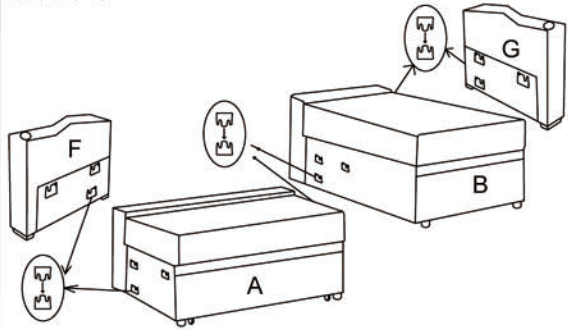

STEP 4

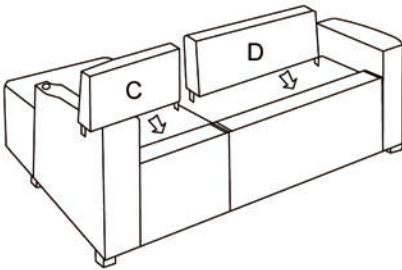

STEP 5

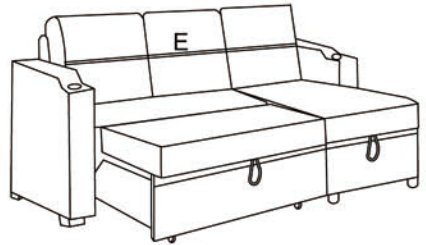

FUNCTION:

