

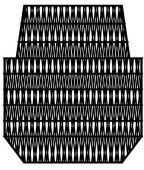



CEILING LAMP

| PARTS LIST/Liste des pièces | |
|--|---|
| A |  x1 |
| B |  x1 |
| C |  x1 Bulb not included |
| Bulb Recommendation: ZUO ITEM#P50027(LED Bulb 6W) is recommended, purchase separately. | |
| D | D. 1  x3 |
| | D. 2  x2 |
| | D. 3  x2 |

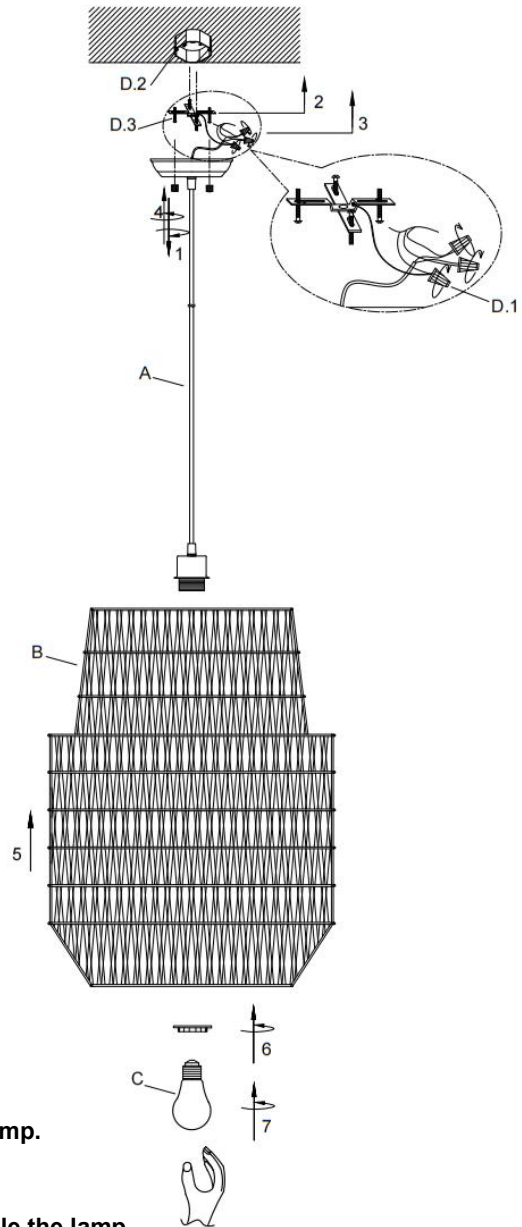

Assembly Instructions:

1. Before assembling, turn the power switch off or unplug the lamp.
2. Use one (1) E26, Type A, Max. 60W or LED Max. 6W light bulb.
3. To avoid scratches and damages, use proper tools to assemble the lamp.
4. For safety, keep children away from the electric parts of the lamp.

If the external wire or cable is damaged, only the manufacturer, service agent or qualified electrician can do the repairing to avoid danger.

Instructions d'Assemblage:

1. Avant l'assemblage, couper la source d'alimentation du courant électrique.
2. Utiliser une ampoule (1) E26, Type A, Max. 60W ou LED Max. 6W.
3. Pour éviter de faire des égratignures et dommages, ne pas se servir d'outils durs ou pointus pour l'assemblage de cette lampe.
4. Pour leur protection, tenir les enfants loin des conduits électriques.

Si un fil ou câble extérieur se brise, faire réparer seulement par le fabricant, son agent ou une personne qualifiée afin d'éviter tout danger.