

INSTALLATION

Assembly Instructions

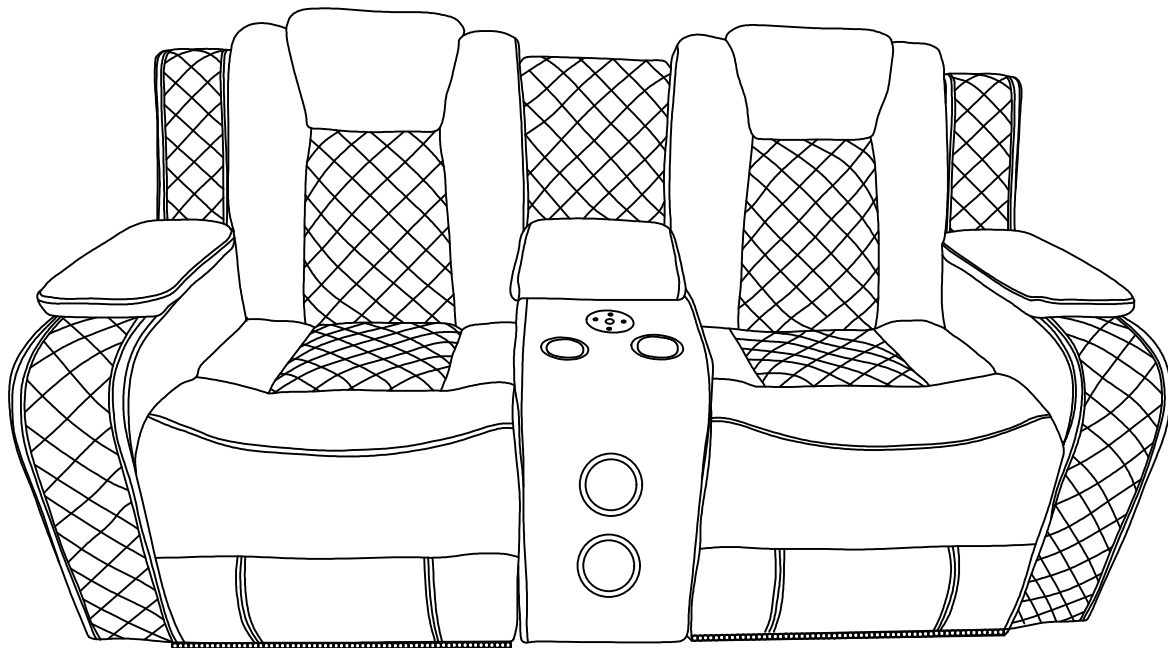

Your chair comes packaged in one box. Carefully remove all of components from the packaging and set aside for assembly.

CAUTION:
DO NOT use any sharp objects to open plastic wrapped components as damage to product or components may result.



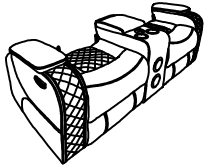

ASSEMBLY INSTRUCTIONS

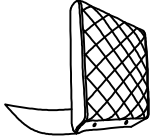
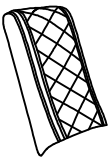
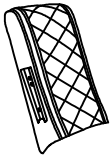
PARTS LIST

PART	DRAWING	DESCRIPTION	QTY
A		Seat Body	1
B		LSF Backrest	1
C		RSF Backrest	1
D		Console Backrest	1
E		Left ear	1
F		Right ear	1

HARDWARE LIST

PART	DRAWING	DESCRIPTION	QTY
G		Adaptor	1
H		Power supply	1
I		Star knob bolt (Ø1/4" X50MM)	2

ASSEMBLY INSTRUCTIONS

STEP 1

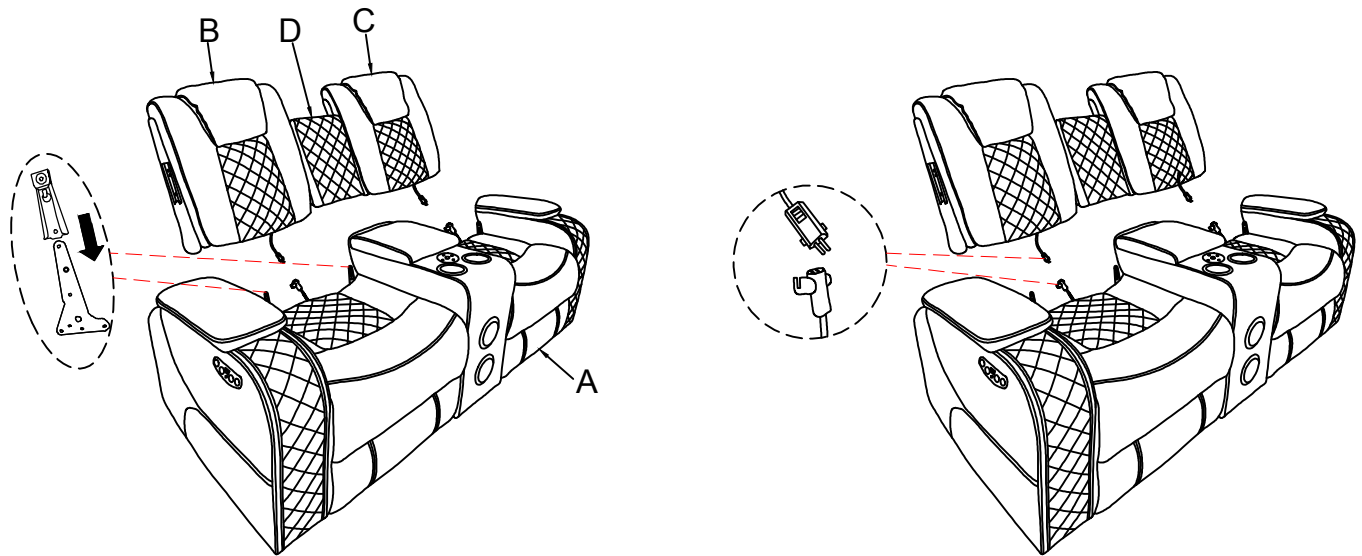

STEP 2

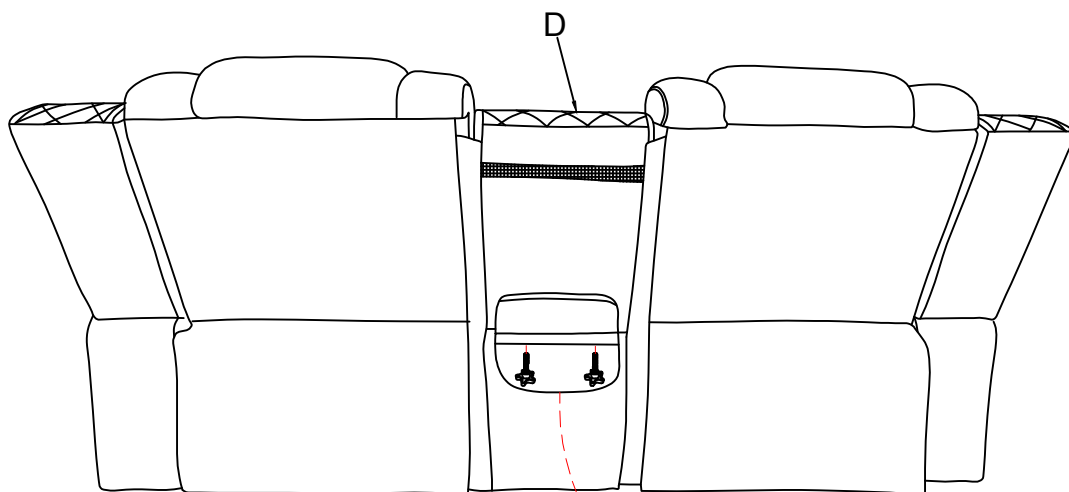

Open the back zipper and assemble as shown below.

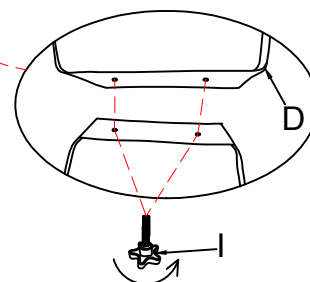

ASSEMBLY INSTRUCTIONS

STEP 3

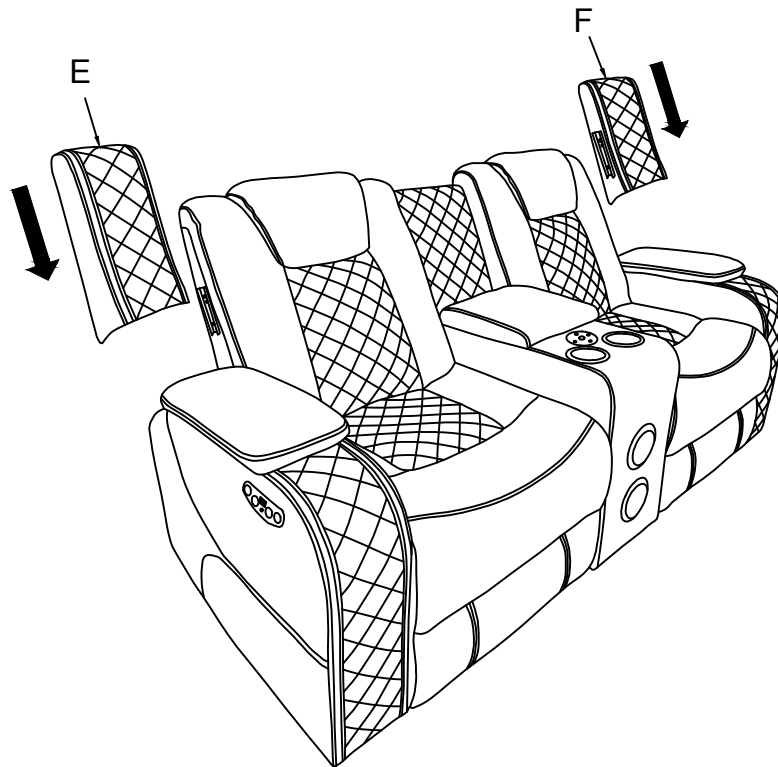

STEP 4

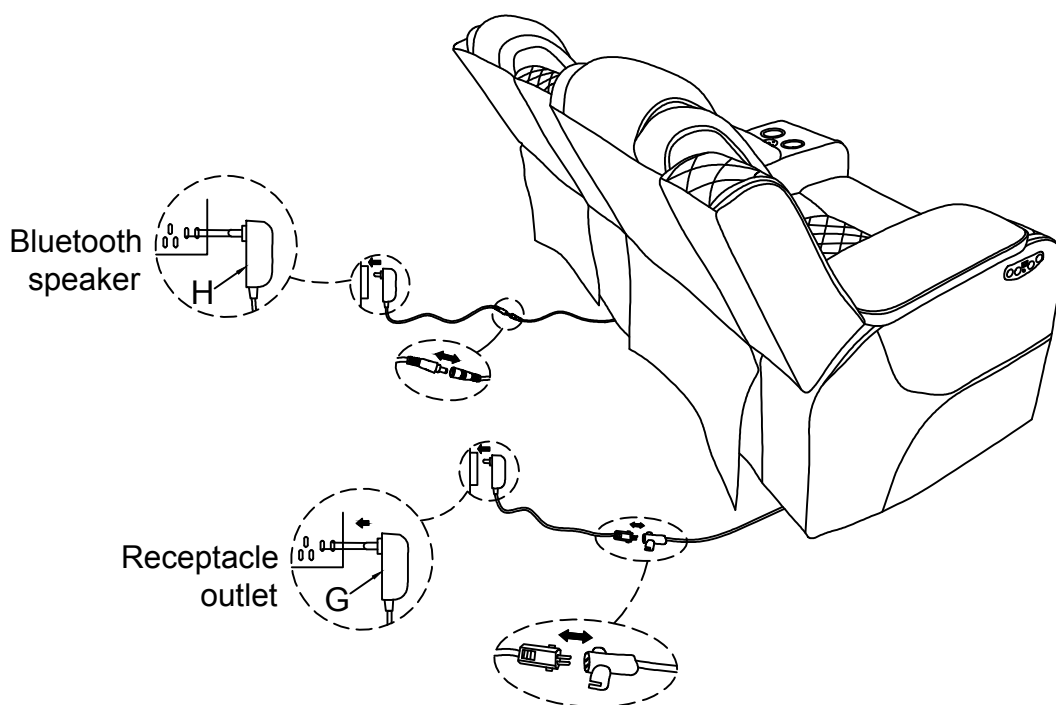

ASSEMBLY INSTRUCTIONS

STEP 5

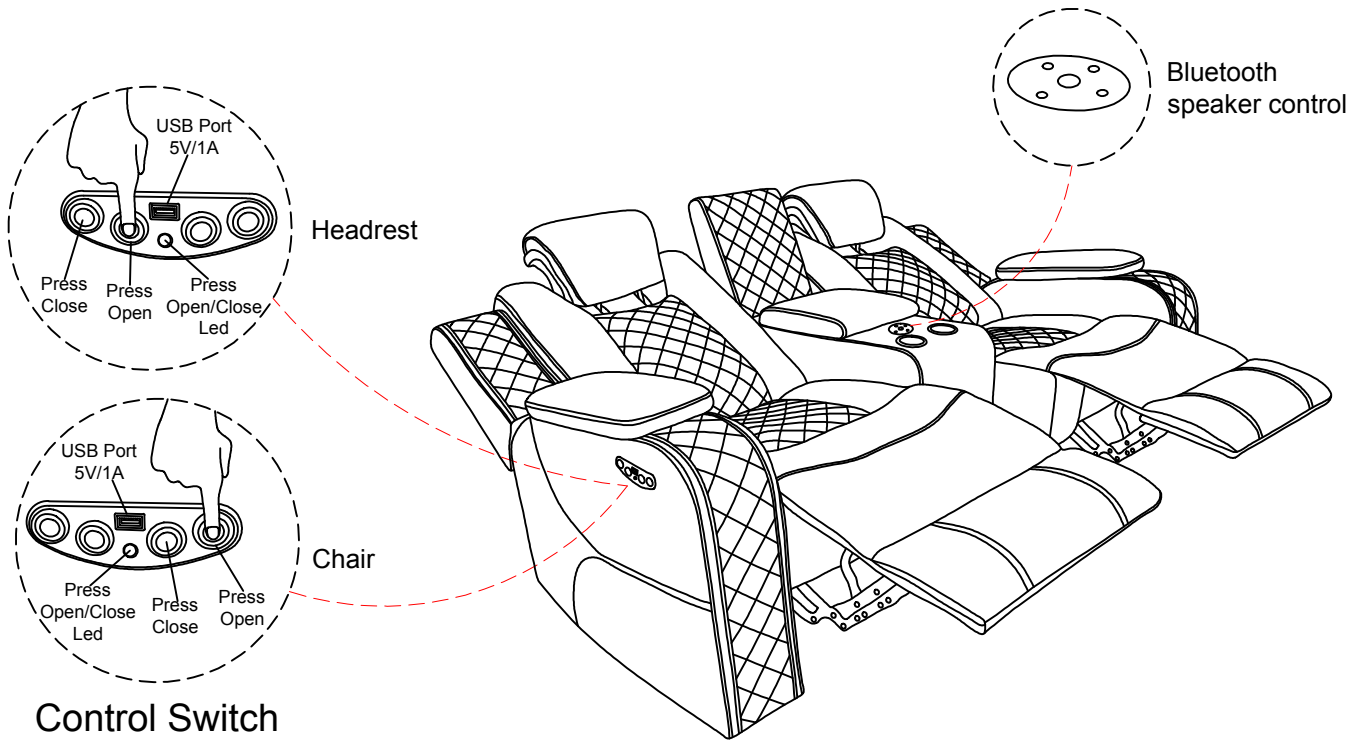

STEP 6

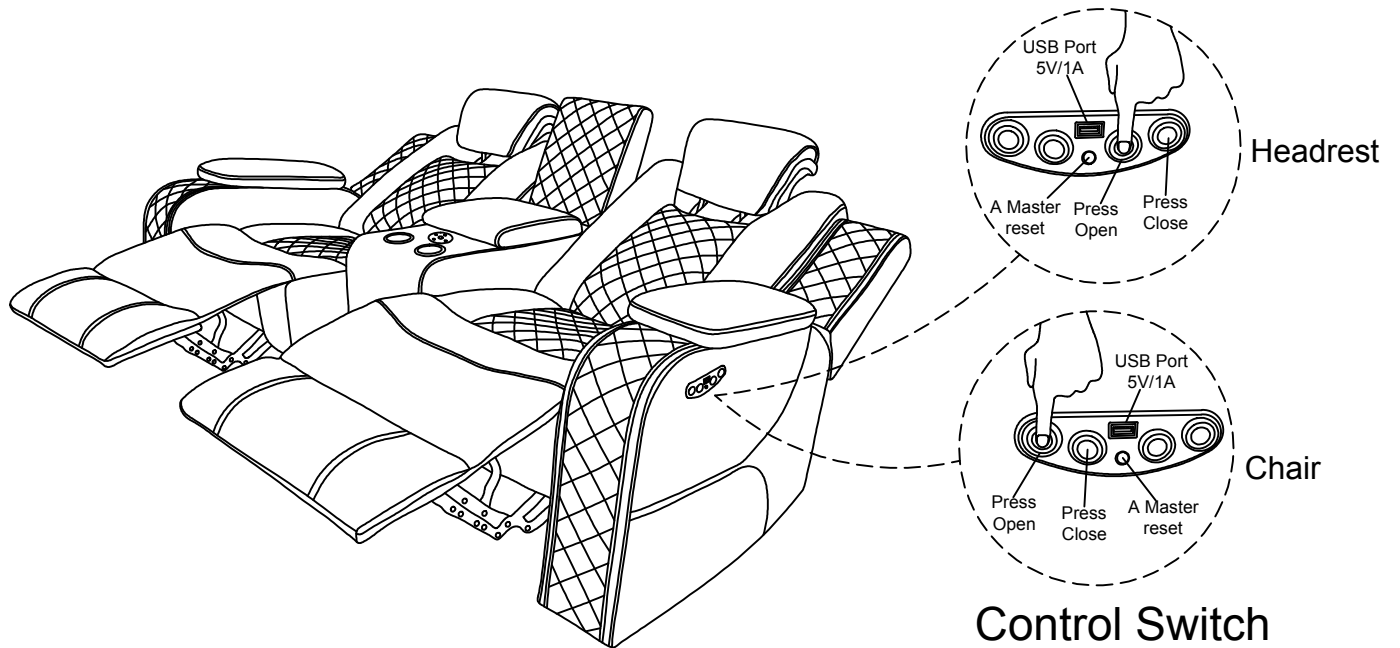

ASSEMBLY INSTRUCTIONS

STEP 7

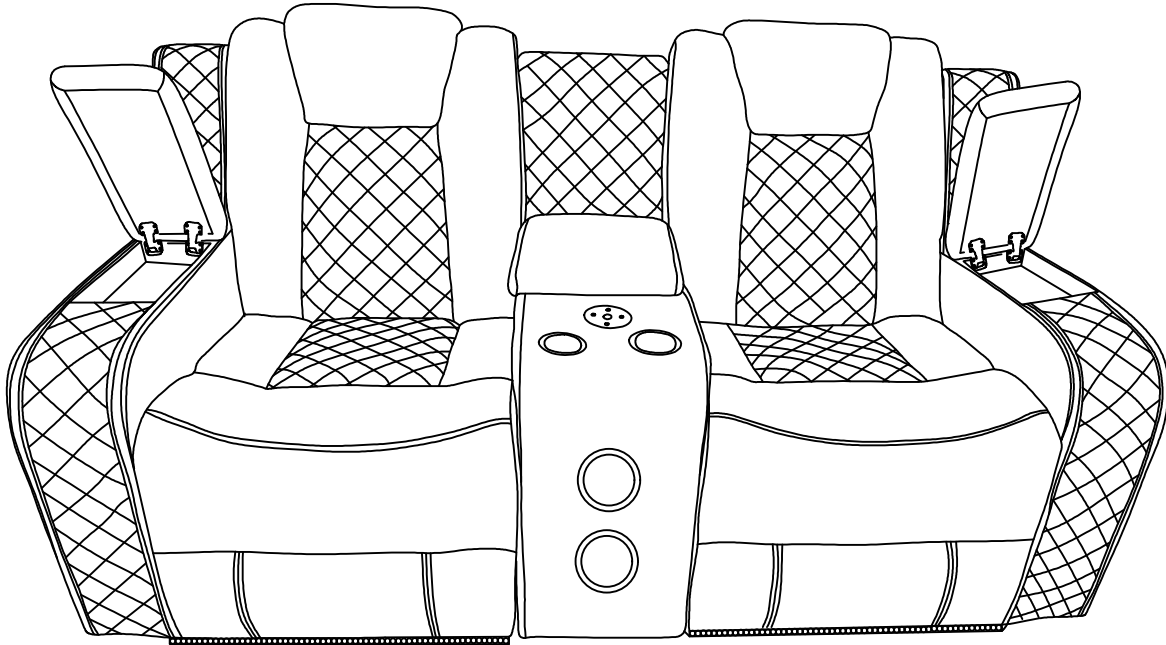

Warnings

1. Please check if the components of the chair are all included and can be used normally as the 5th tip.
2. Assemble all components according to the instruction correctly before you connect the chair with the power.
3. Please DO NOT sit on the armrests and footrest to eliminate the risk of tipping over.
4. If the sofa is damaged or doesn't match the website product, please send clear pictures of the product and label of the carton to our service team, and we'll help you to solve the problem.
5. If the recliner doesn't work, you can try the following measures for self-checking firstly:
 - ① Check if all the cable are connected;
 - ② Check if the light of transformer is on.If the chair still doesn't work, please feed the information back to the customer service in time. We will help solve the problem for you as soon as possible.

