

ASSEMBLY INSTRUCTIONS

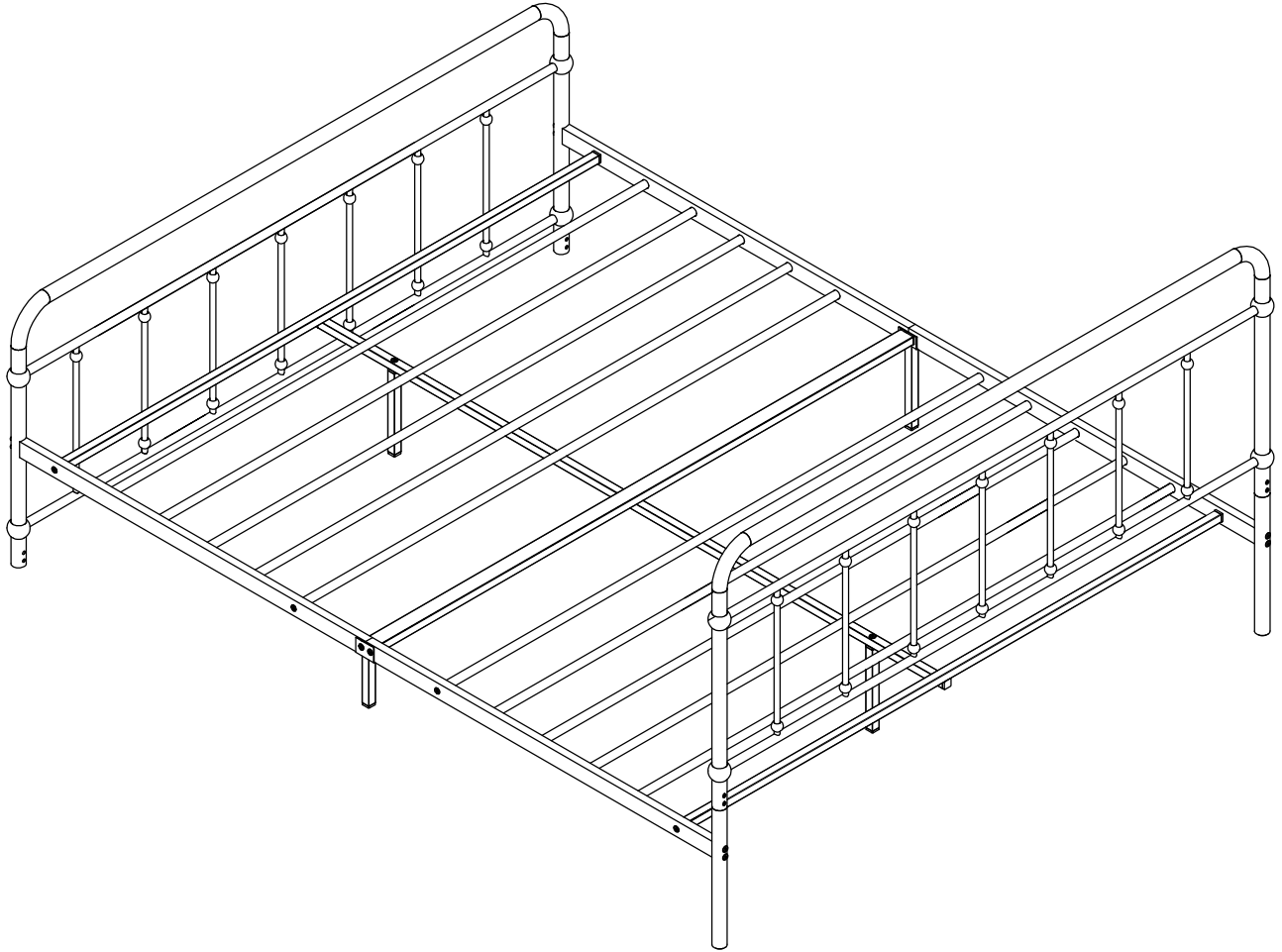

Description : ***GARLAND FULL BED***

Dimension : 77L"x56"Wx46"H





Cube Size 1 : 60"x 27"x 6"

NW: 44.4 LBS



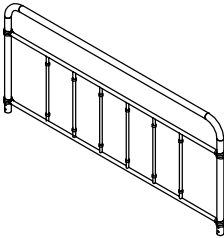

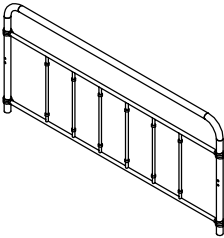
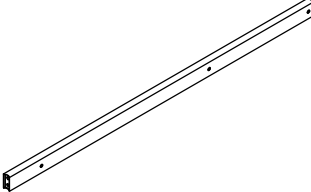
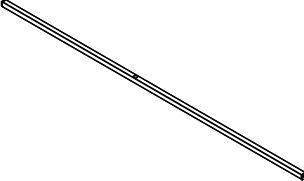
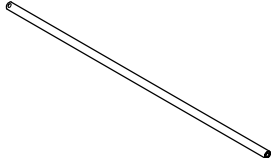
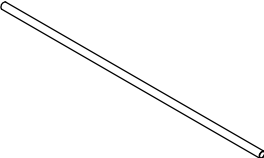
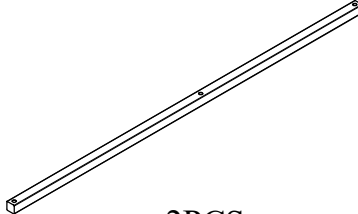
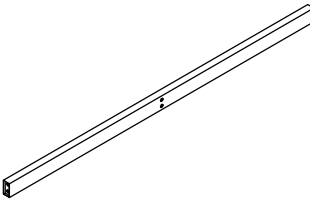
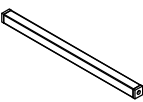

GW: 55.4 LBS

GARLAND FULL BED

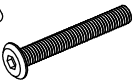
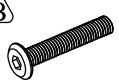
PART LIST

 <p>1PC</p>	 <p>2PCS</p>	 <p>1PC</p>	 <p>4PCS</p>
 <p>2PCS</p>	 <p>2PCS</p>	 <p>8PCS</p>	 <p>2PCS</p>
 <p>1PC</p>	 <p>2PCS</p>		 <p>2PCS</p>

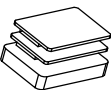
HARDWARE LIST

 <p>A 1/4"*50 8PCS</p>	 <p>B 1/4"*40 10PCS</p>	 <p>C 1/4"*30 4PCS</p>	 <p>D 1/4"*15 8PCS</p>	 <p>E Ø33x10 4 PCS</p>	 <p>F 20x20x10 4PCS</p>	 <p>H 4x60 2PCS</p>
---	--	---	---	--	--	--

IMPORTANT SAFETY NOTICE: READ CAREFULLY BEFORE BEGINNING ASSEMBLY!

- ⚠ Hardware packs and small components should be away from the children, avoid eating and being injured
- ⚠ Please, follow with the assembly steps in order
- ⚠ Please, do not tighten any screw before each assembling unit is well placed in appropriate position
- ⚠ Please, make sure all components are fixed firmly locked without any potential safety hazard. After assembly and before using
- ⚠ Please, use this product correctly, according to its purpose to avoid danger happened
- ⚠ Please, do not stand on any component of this product, except the ladder of this product after fixing locked safely
- ⚠ Such as the wall fastening devices are essential parts of this product. Please fix firmly locked without any potential safety hazard before using
- ⚠ Please check all contents of this product inside of carton (s) carefully, small parts may have been lost during shipment, if any! contact further with the retailer from which you purchased this product to obtain, do not use any substitute part
- ⚠ This assembly instructions booklet contains important safety information, please read and keep for further reference
- ⚠ This products is designed referring to overall loading of each set final product, Please avoid to load on single point of final product making damaged
product name : Garland full Bed : 400 LBS (maximum)

GARLAND FULL BED

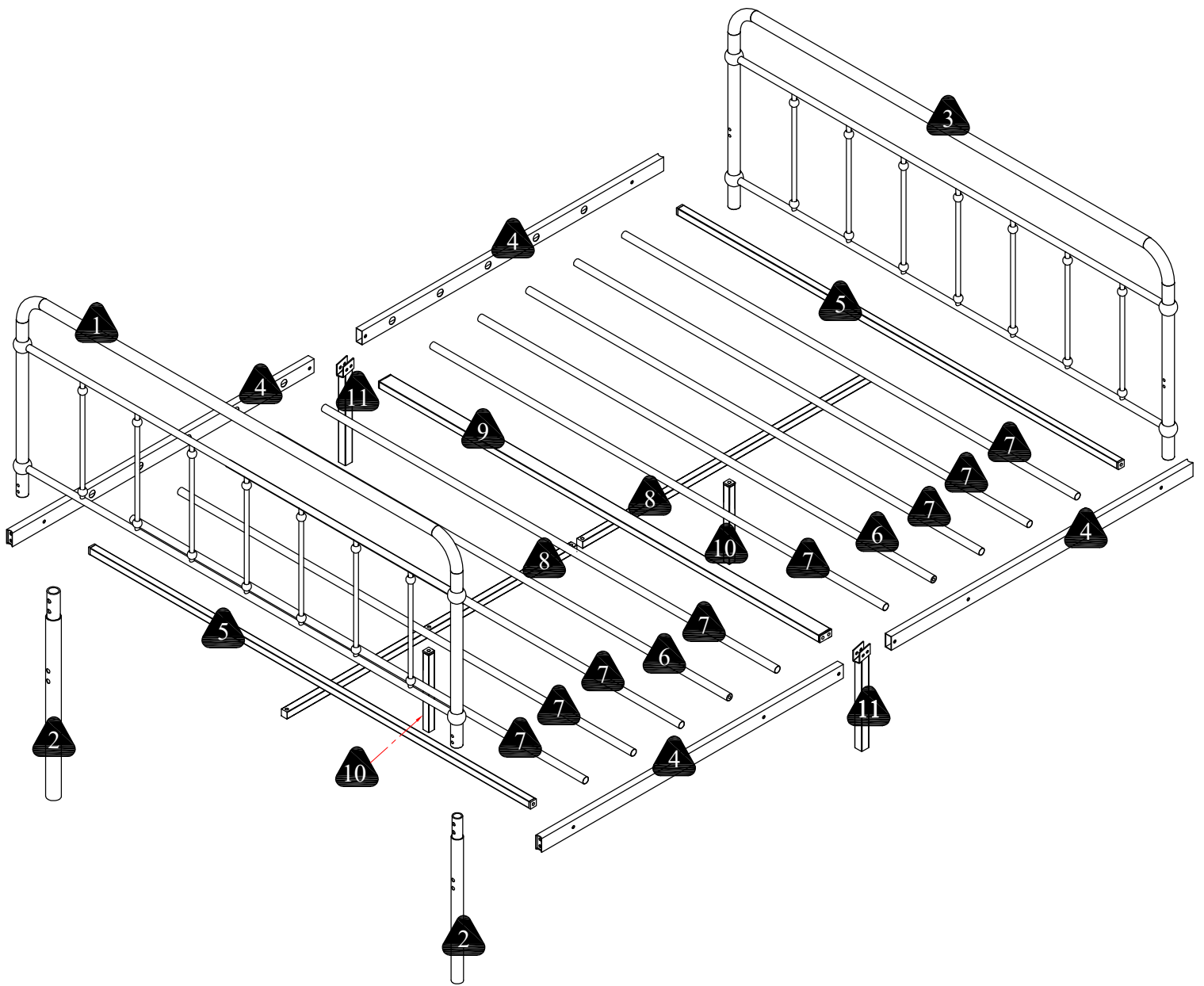

GARLAND FULL BED

STEP 1

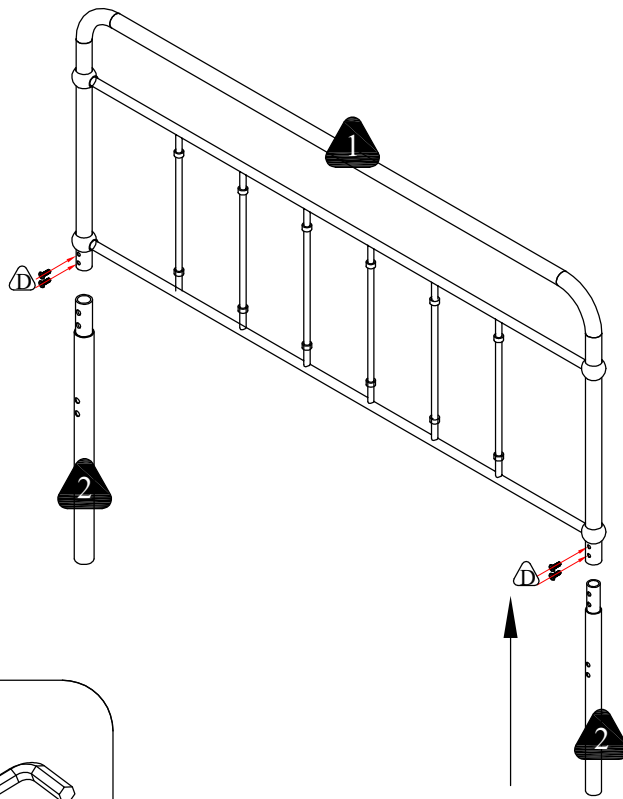

D

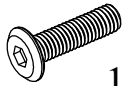

1/4"*15
4 PCS

H

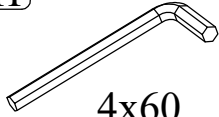

4x60
2PCS

STEP 2*2

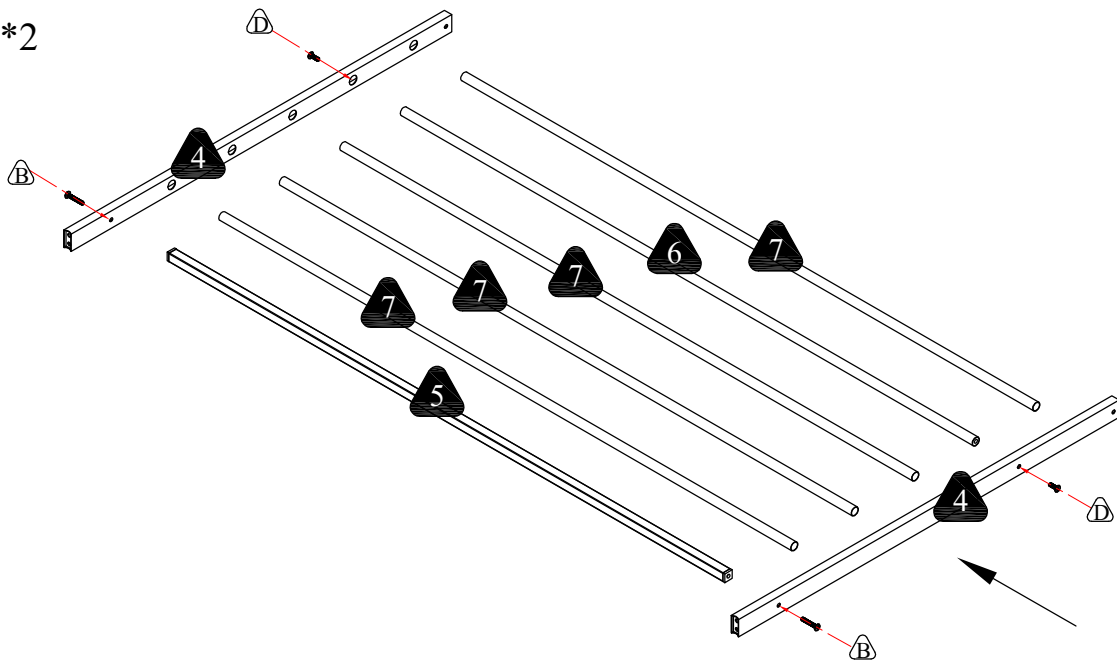

B

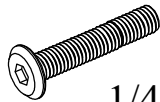

1/4"*40
4 PCS

D

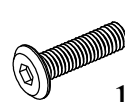

1/4"*15
4 PCS

H



4x60
2PCS

GARLAND FULL BED

STEP 3

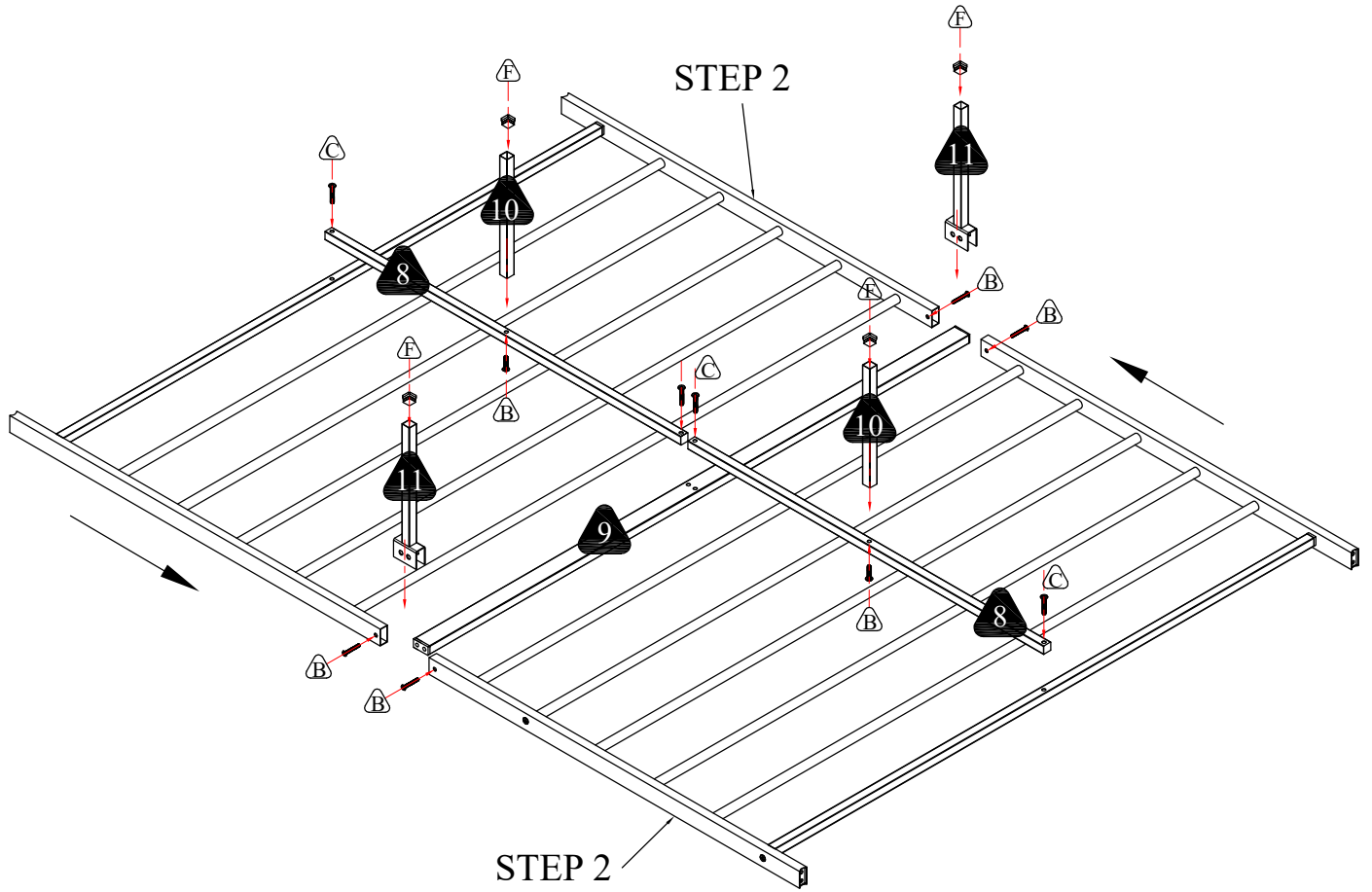

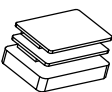
F 
20x20x10
4PCS

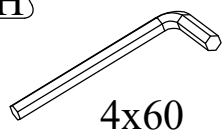
H 
4x60
2PCS

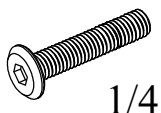
C 
1/4"*30
4 PCS

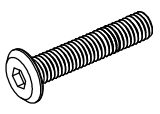
B 
1/4"*40
6 PCS

GARLAND FULL BED

STEP 4

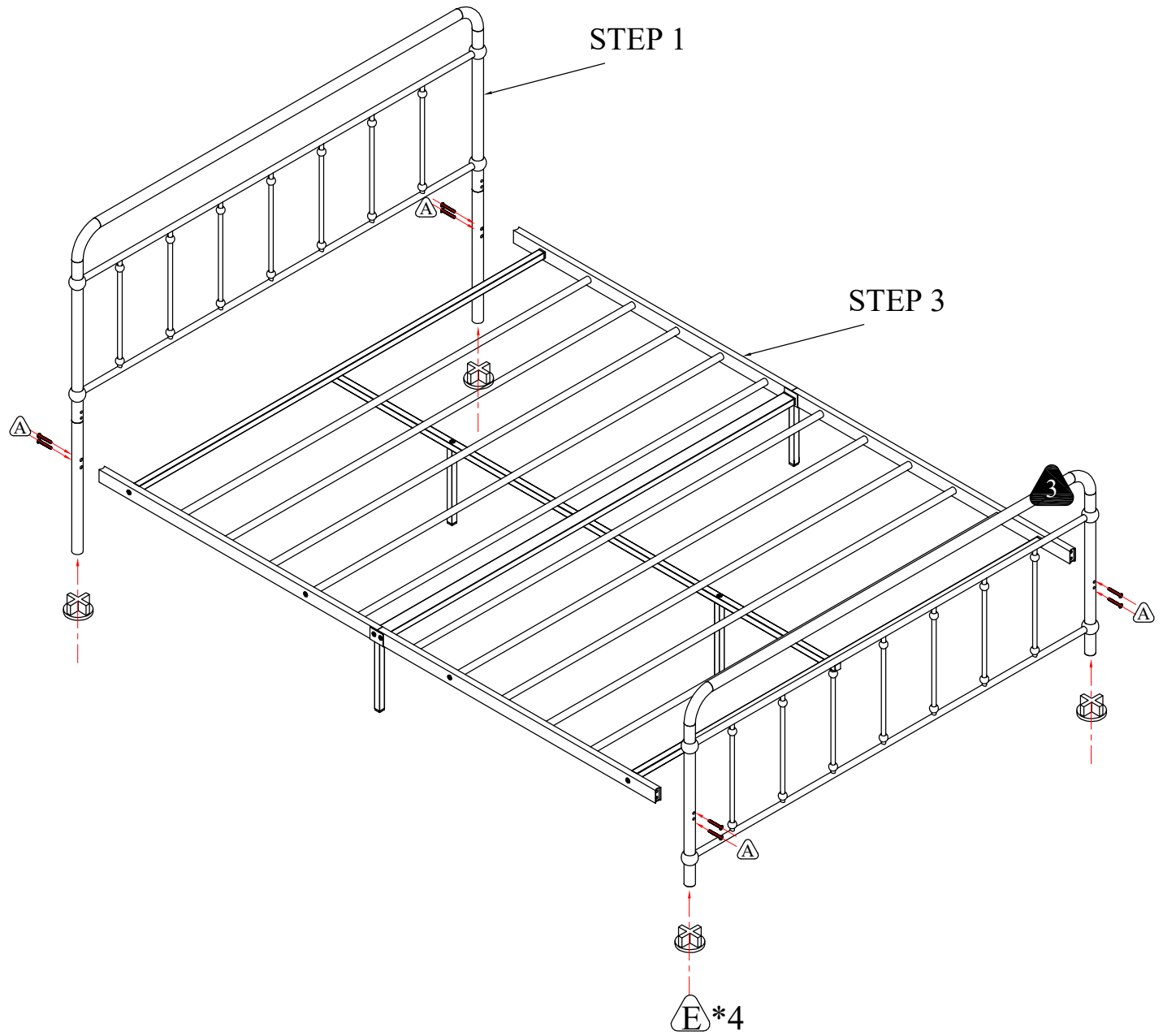

A

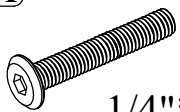

1/4"*50
8 PCS

H



4x60
2PCS

E



Ø33x10
4 PCS

GARLAND FULL BED