



**Best Master Furniture™**  
The Imported Furniture Specialist

**MODEL: QT05-MIRROR**

# ASSEMBLY INSTRUCTIONS

Hours of Operation  
MON-FRI 8:00AM - 4:00PM (PT)

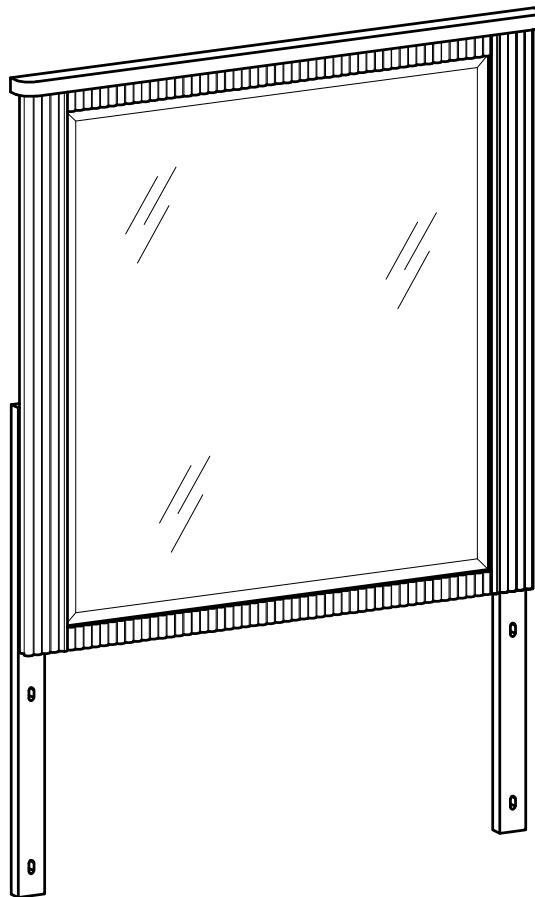

2 - People

Enjoying this product? We'd love your 5-star review!  
If you have any issues, our support team is happy to help.



**Best Master Furniture™**  
The Imported Furniture Specialist

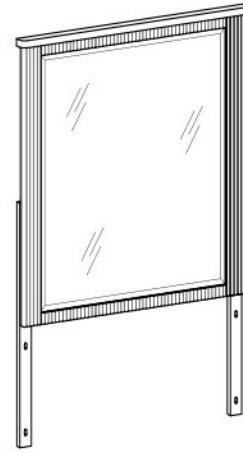

Thank you for your purchase



Monday-Friday  
8:00AM - 4:00PM PT



@Email  
inquiries@bestmasterfurnitures.com



www.bestmasterfurnitures.com



**CHECK  
BEFORE STATING**

Are you missing anything?

Please double check all hardware and parts match the assembly guide before putting the product together. If damaged, we suggest you put the item back in the box and start your claim or return

Should we send any replacements?

If there are any manufacturer defects or missing pieces please contact us for replacements. If purchased online, please contact the website of where you purchased it from, DIRECTLY

## **IMPORTANT INFO before assembly:**

If there's a problem with the parts do not attempt to assemble the product

- Place all parts on a clean and smooth surface such as a rug/carpet to avoid parts from being scratched
- When tightening screws to product do not overtighten until product is fully setup
- If product is too heavy for a single person to carry do not attempt and ask for assistance
- DO NOT DRAG or PUSH item to desired location. Must be carried when moving
- If item is not working as intended please review the assembly guide to see if any steps were missed or incorrectly built. If there's a problem with part please contact seller for additional assistance
- Please keep all hardware and small parts away from pets/infants
- Please wear gloves or protective gear to protect from getting cuts
- It is normal for new furnitruue to have an off gassing smell. Please air out furniture near a window for a few hours or a day before placing it in its desired location
- All products may have a slight color and texture variation due to different shipments,natural materials, screen- resolutions, or lighting in home. Images are rendered by different devices or websites



**Best Master Furniture™**  
The Imported Furniture Specialist

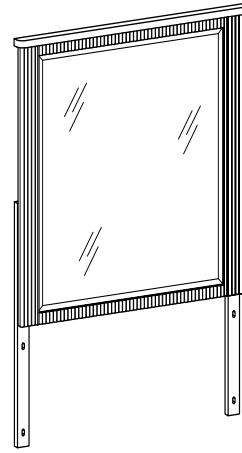

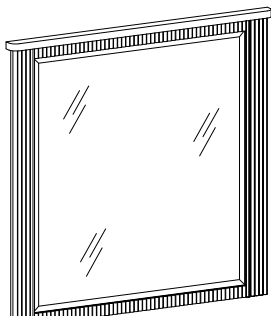
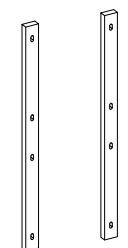

**MODEL:QT05-MIRROR**

### PARTS LIST

<p><b>A</b></p>  <p>Mirror = 1pc</p>	<p><b>B</b></p>  <p>Support bar = 2pcs</p>
--	--

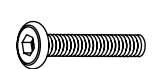
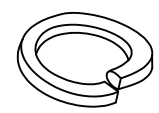
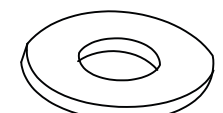
### HARDWARE LIST

<p><b>1</b></p>  <p>Bolt M6x50 = 8 pcs</p>	<p><b>2</b></p>  <p>Lock washer M8 = 8 pcs</p>	<p><b>3</b></p>  <p>Flat washer M8 = 8 pcs</p>
<p><b>4</b></p>  <p>Allen Key K4 = 1pc</p>		



**Best Master Furniture™**  
The Imported Furniture Specialist

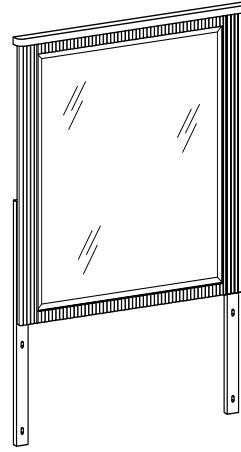

**MODEL:QT05-MIRROR**

Step 1:

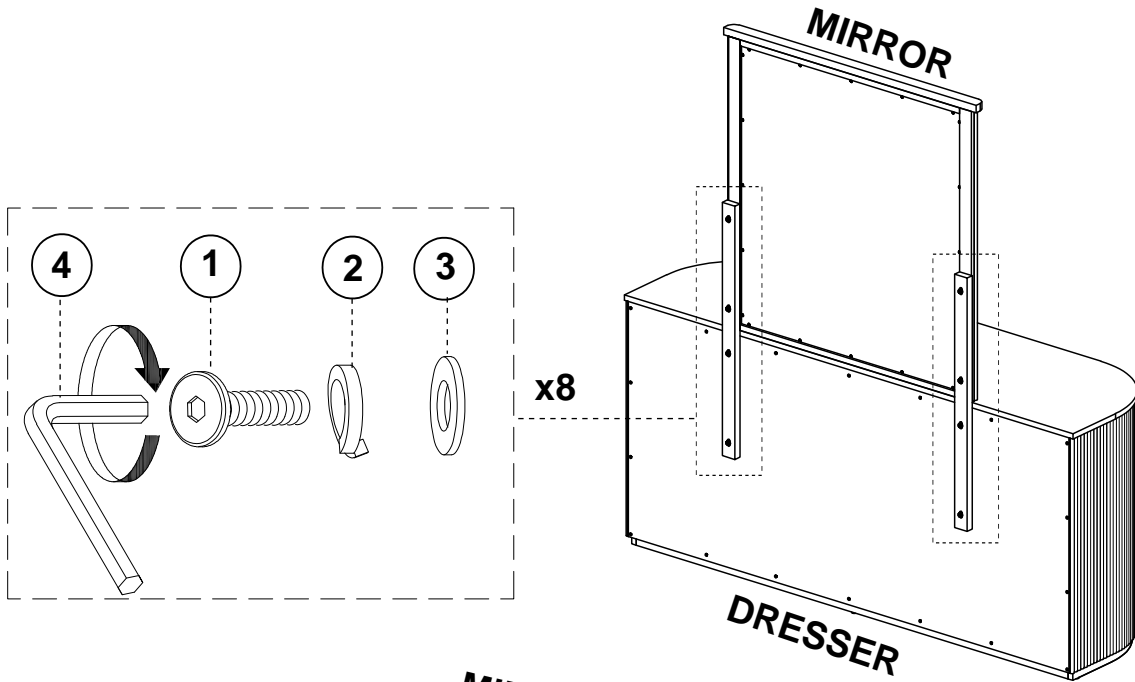

Step 2:

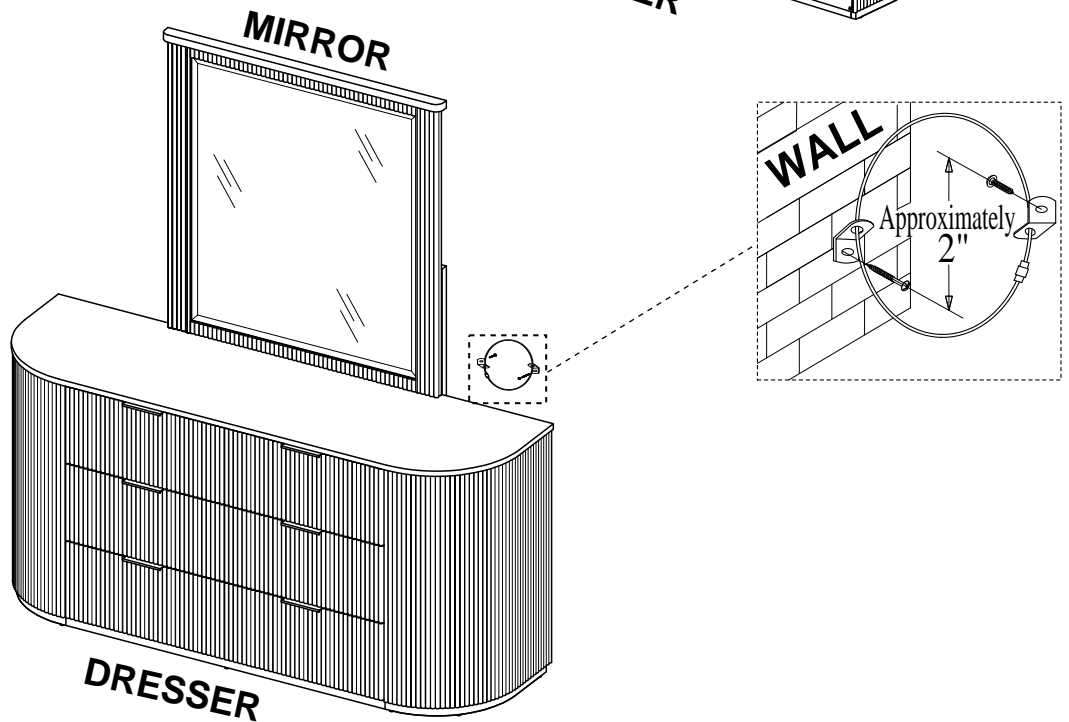

**PLEASE NOTE:** To help prevent the possibility of tip-over, install the tipover restraint provided.