

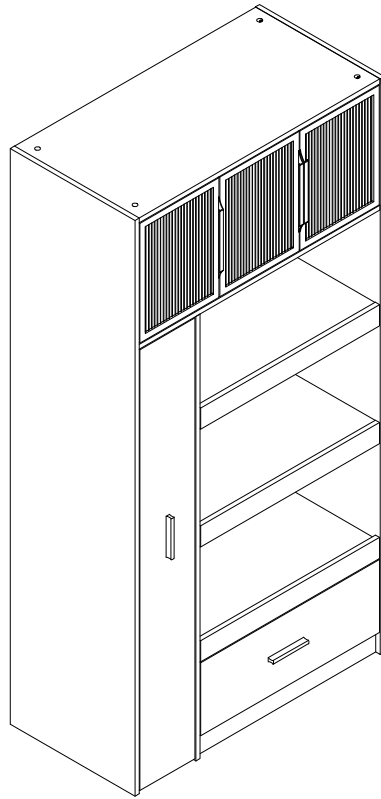

Installation & Assembly

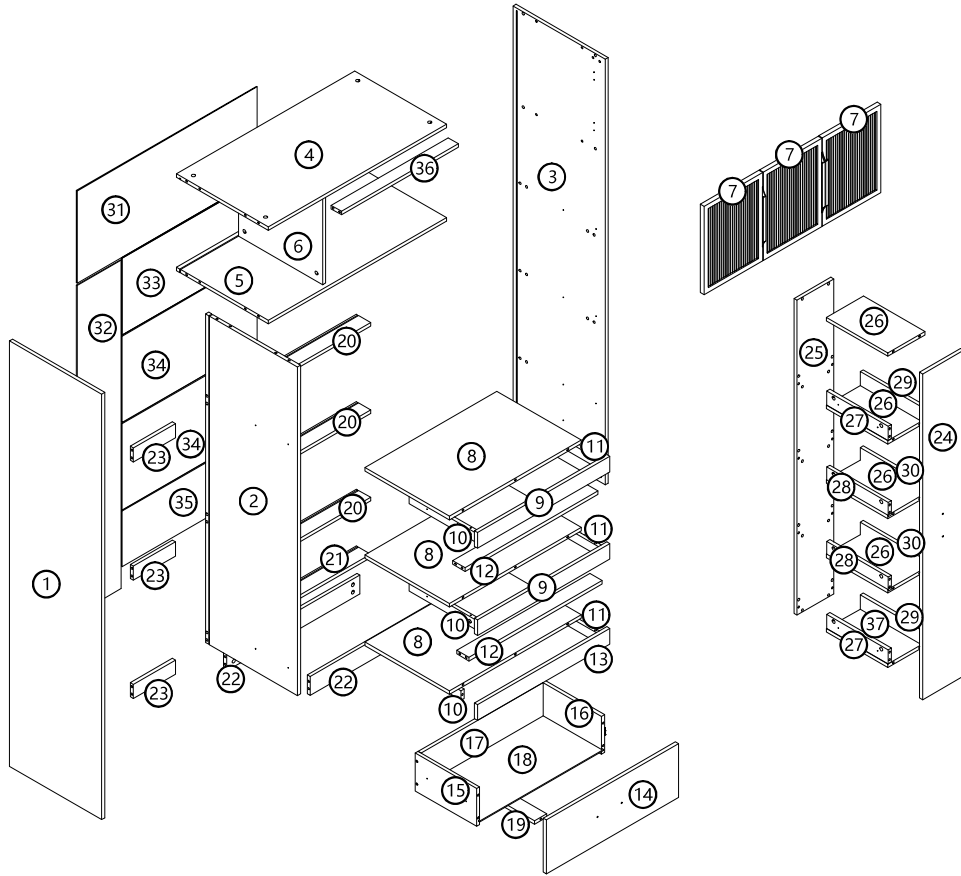

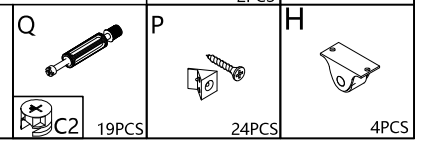

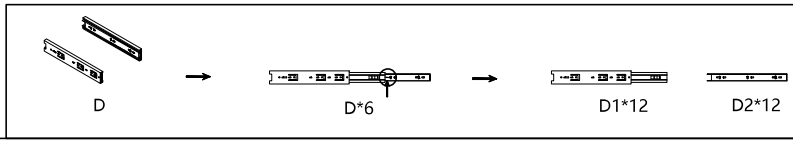

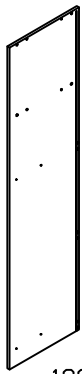

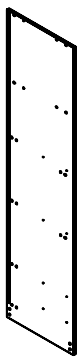
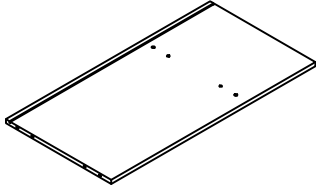
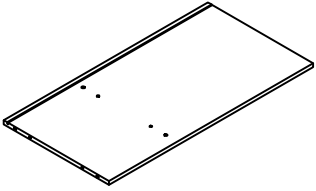
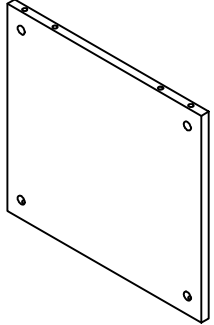
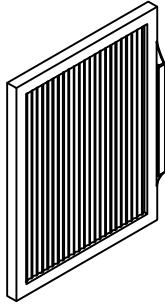
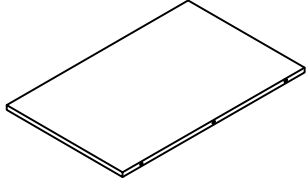
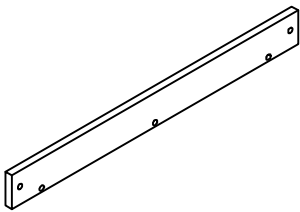
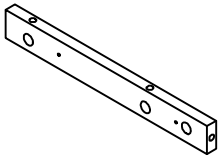
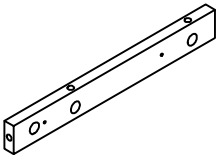
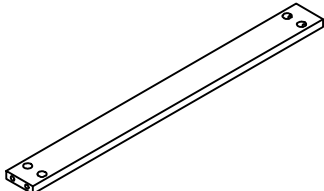
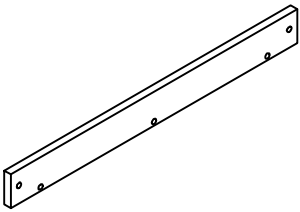
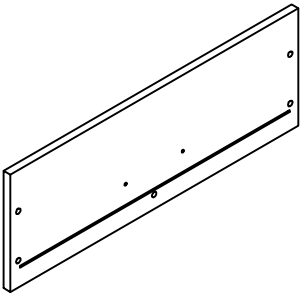
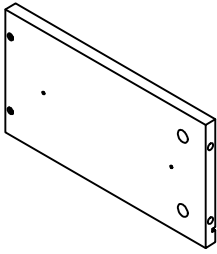
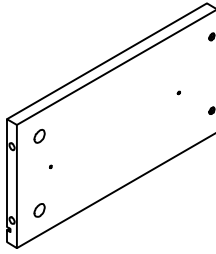
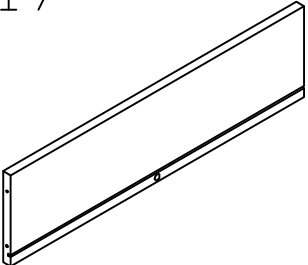
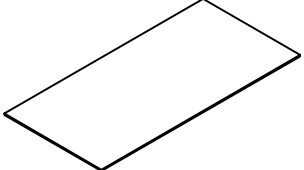
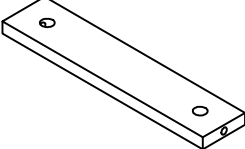
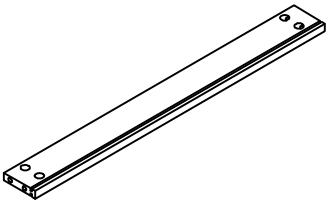
I	A
4PCS	36PCS
J	B
2PCS	36PCS
K	C
12PCS	94PCS
L	D
24PCS	6PCS
M	E
4PCS	12PCS
N	F
125PCS	20PCS
O	G
2PCS	2PCS
Q	H
19PCS	
P	H
24PCS	4PCS

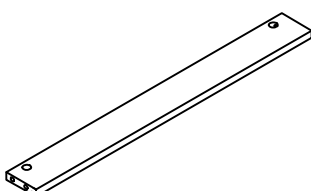
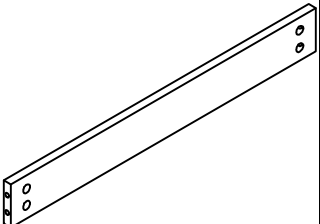
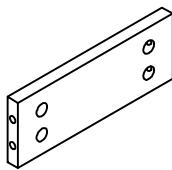

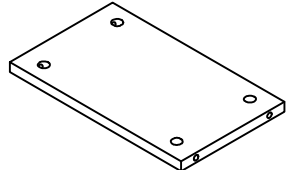
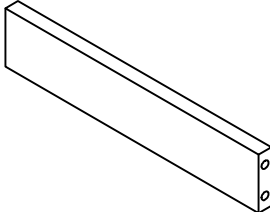
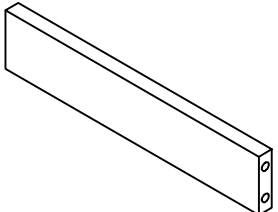
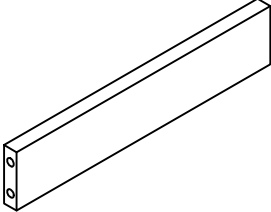
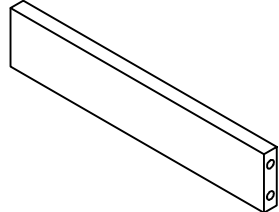
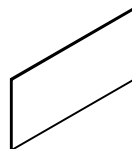
<p>1</p>  <p>1800*450 1PS</p>	<p>2</p>  <p>1389.5*449 1PS</p>	<p>3</p>  <p>1800*450 1PS</p>	<p>4</p>  <p>870*449 1PS</p>
<p>5</p>  <p>870*449 1PS</p>	<p>6</p>  <p>380*411 1PS</p>	<p>7</p>  <p>374*286 3PS</p>	<p>8</p>  <p>645*412.5 3PS</p>
<p>9</p>  <p>646*66 2PS</p>	<p>10</p>  <p>330*40 3PS</p>	<p>11</p>  <p>330*40 3PS</p>	<p>12</p>  <p>650*60 2PS</p>
<p>13</p>  <p>646*66 1PS</p>	<p>14</p>  <p>646*228 1PS</p>	<p>15</p>  <p>300*160 1PS</p>	<p>16</p>  <p>300*160 1PS</p>
<p>17</p>  <p>601*160 1PS</p>	<p>18</p>  <p>611*298*3 1PS</p>	<p>19</p>  <p>285*60 1PS</p>	<p>20</p>  <p>650*70 3PS</p>

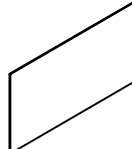
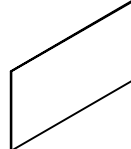
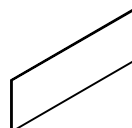
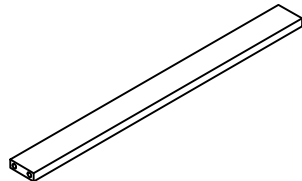
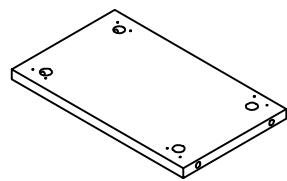

<p>21</p>  <p>650*70 1PS</p>	<p>22</p>  <p>650*80 2PS</p>	<p>23</p>  <p>205*60 3PS</p>	<p>24</p>  <p>1378.5*199 1PS</p>
<p>25</p>  <p>1347.5*181 1PS</p>	<p>26</p>  <p>300*180 4PS</p>	<p>27</p>  <p>300*60 2PS</p>	<p>28</p>  <p>300*60 2PS</p>
<p>29</p>  <p>300*60 2PS</p>	<p>30</p>  <p>300*60 2PS</p>	<p>31</p>  <p>880*390*3 1PS</p>	<p>32</p>  <p>1392*215*3 1PS</p>
<p>33</p>  <p>660*324.5*3 1PS</p>	<p>34</p>  <p>660*365*3 2PS</p>	<p>35</p>  <p>660*235*3 1PS</p>	<p>36</p>  <p>572*50 1PS</p>
<p>37</p>  <p>300*180 1PS</p>	<p>38</p>	<p>39</p>	<p>40</p>

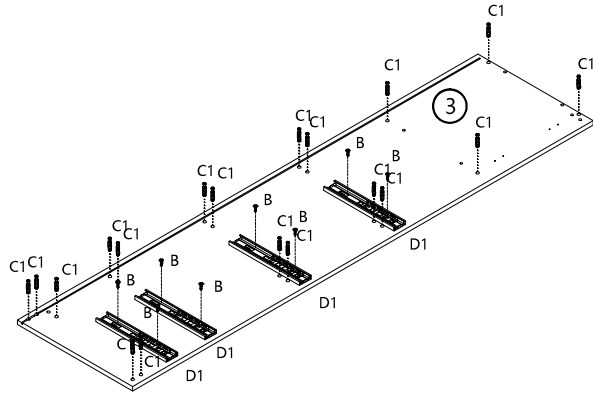
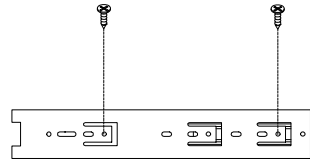
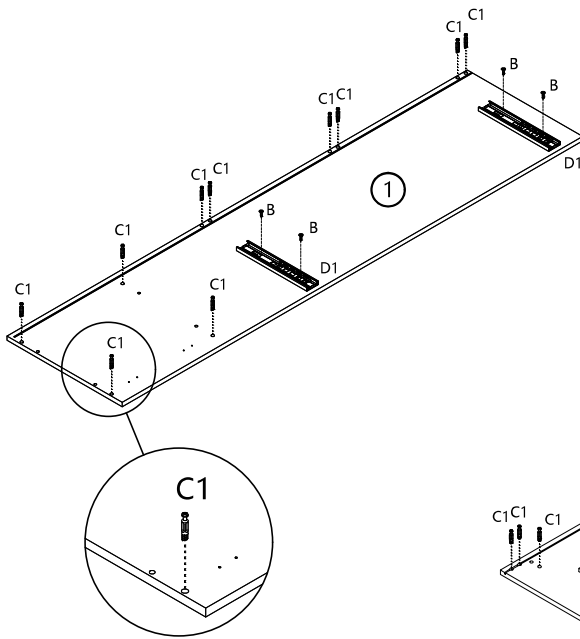
1



put C1 B D1 on board

1 3



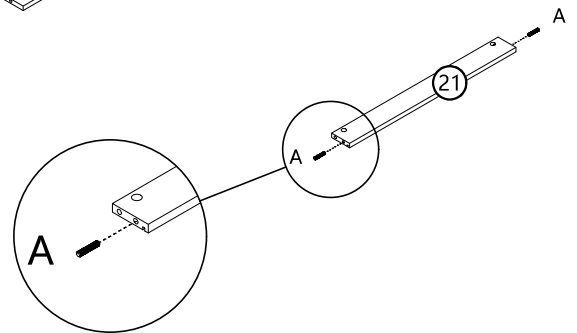
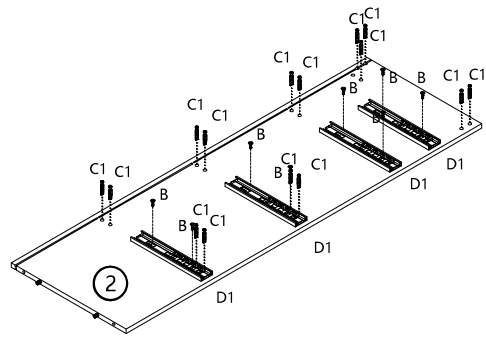
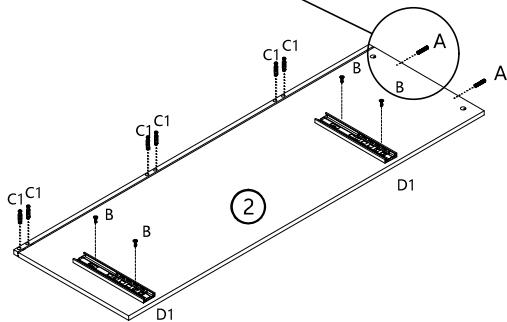
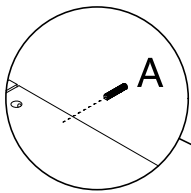
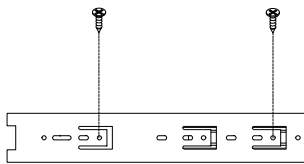

	D1*6
	C1*29
	B*12

2







put C1 B D1 on board (2)

put A on board (2) (21)

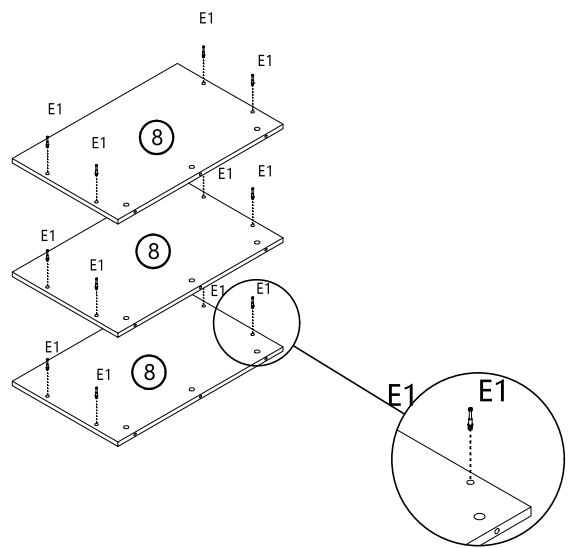
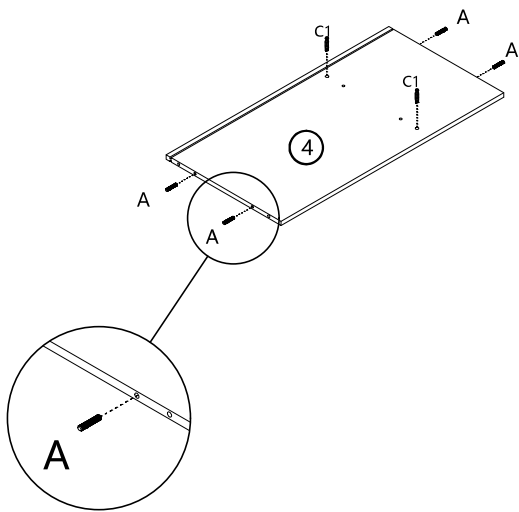
	B*12		A*4
	C1*21		D1*6

3



	A*4
	C1*2
	E1*12

put C1 A on board (4)

put E1 on board (8)

4

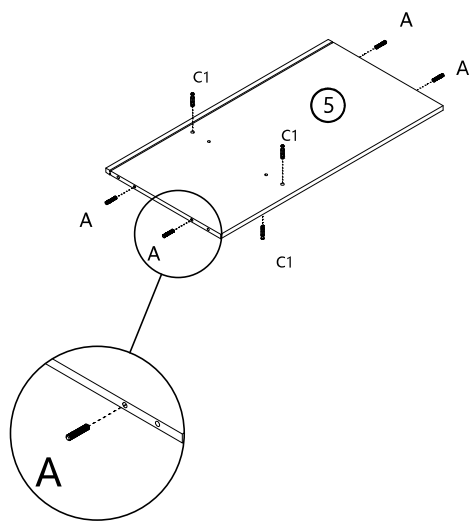

put C1 A on board

5

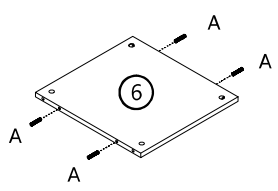

put A on board



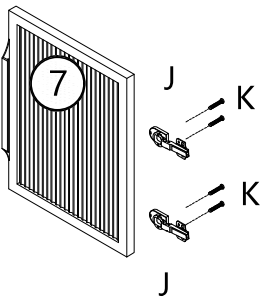

6

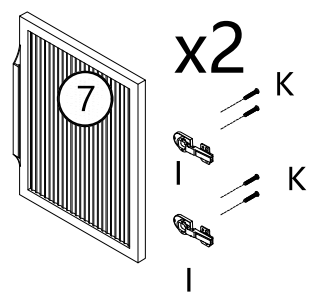

put I K on board

7



	A*8
	K*12
	J*2
	I*4
	C1*4

5

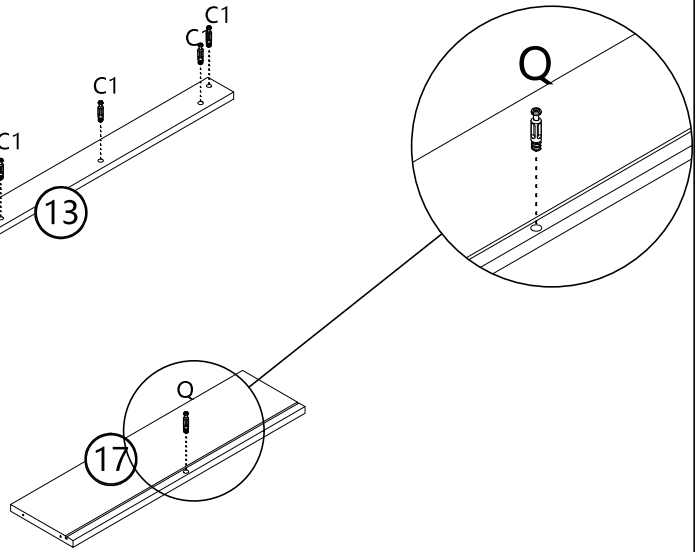
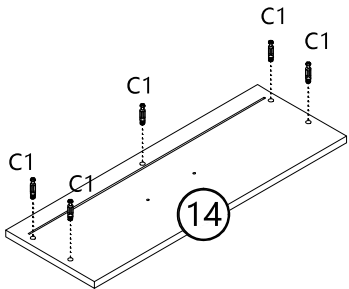
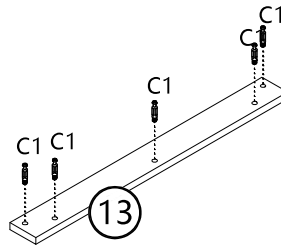
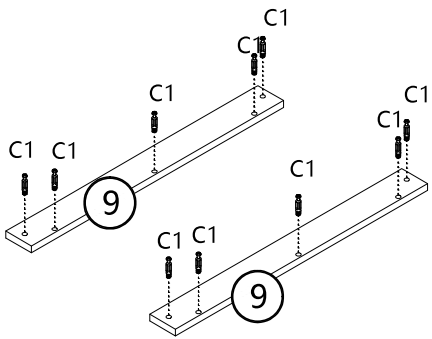



put C1 on board

9 13 14

put Q on board

17

	Q*1
	C1*20

6



put C1 on board

24

put Q on board

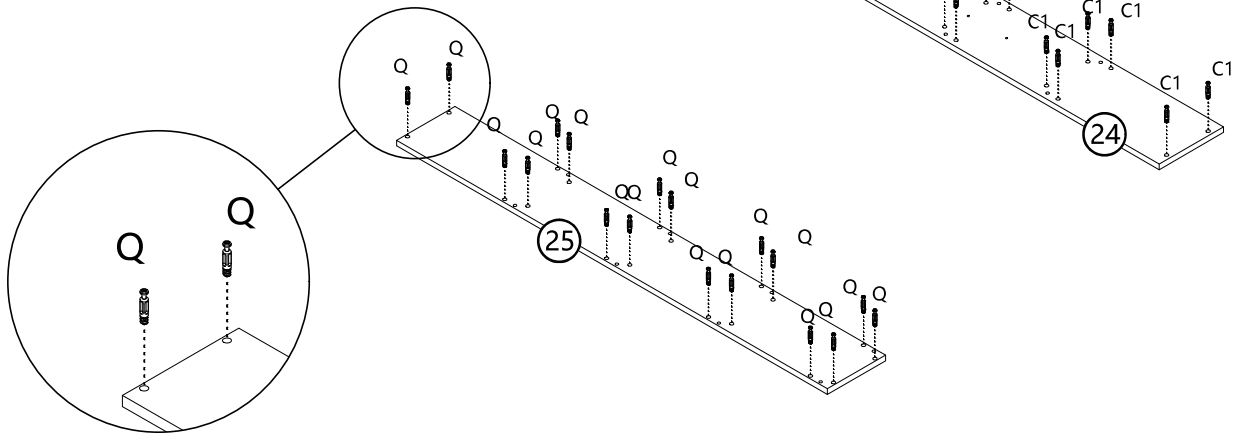
25



	Q*18
	A*4
	C1*18

put A on board

36

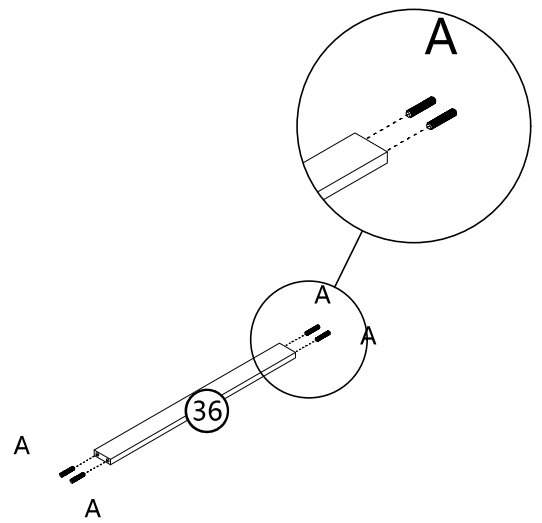

7

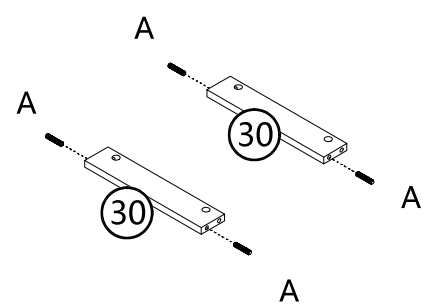
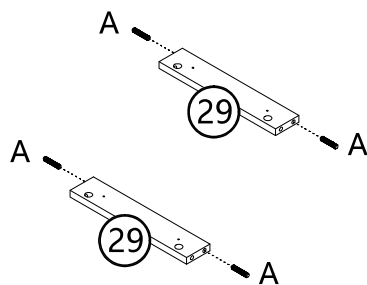
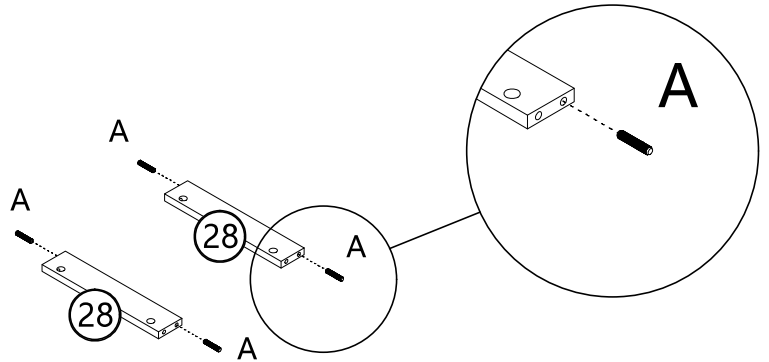
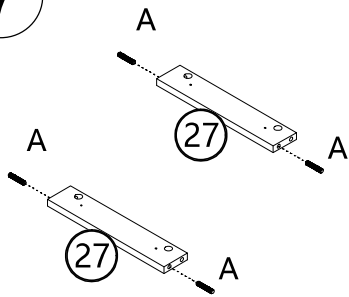

put A on board

(27) (28) (29) (30)



A*16

8

Make sure the arrow on the screw
align to the hole on the side.

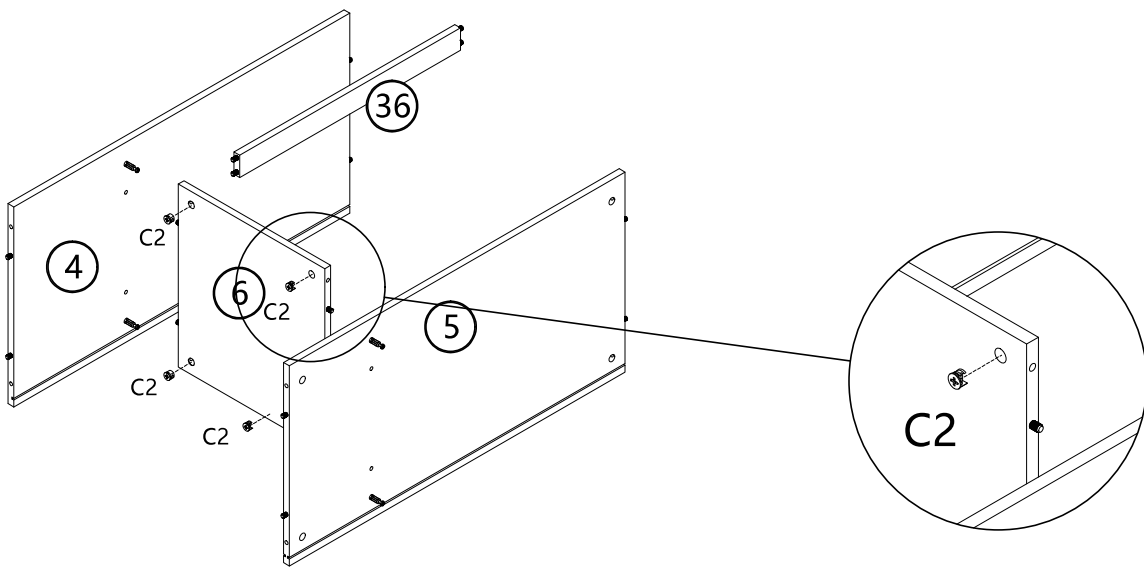

put C2 on board

6



C2*4

9

Make sure the arrow on the screw align to the hole on the side.

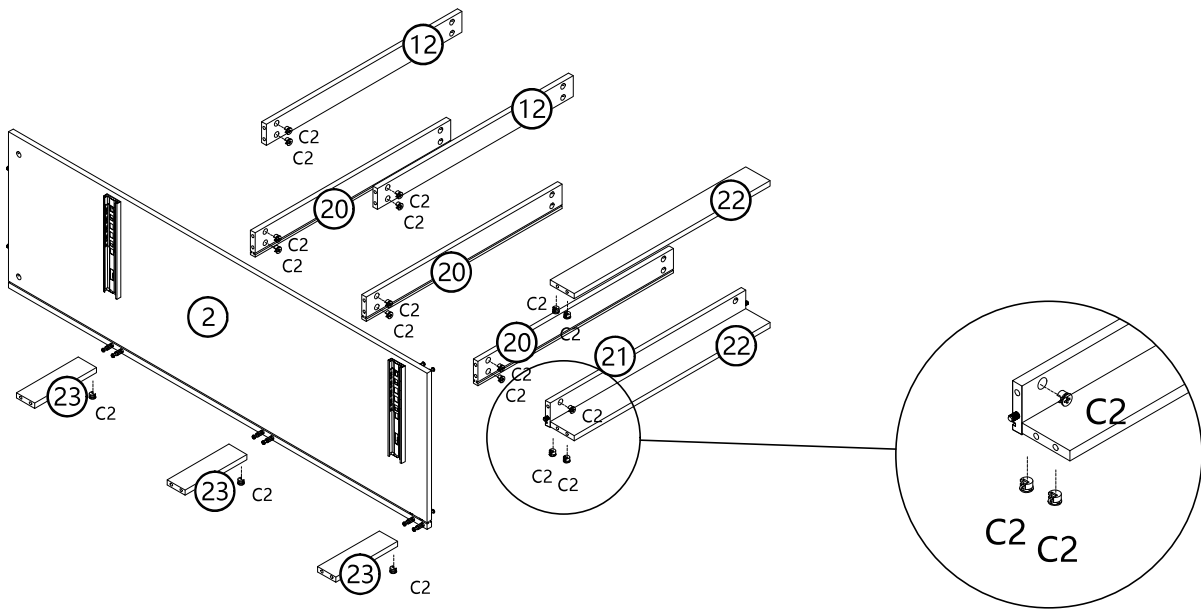

put C2 on board

12 20 21 22 23



C2*21

10

Make sure the arrow on the screw align to the hole on the side.

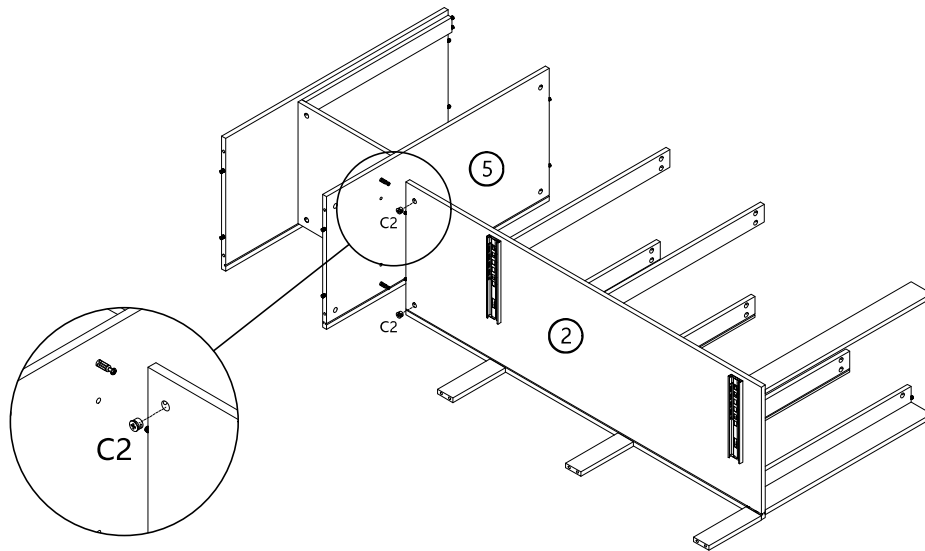

put C2 on board

2



C2*2

11

Make sure the arrow on the screw align to the hole on the side.

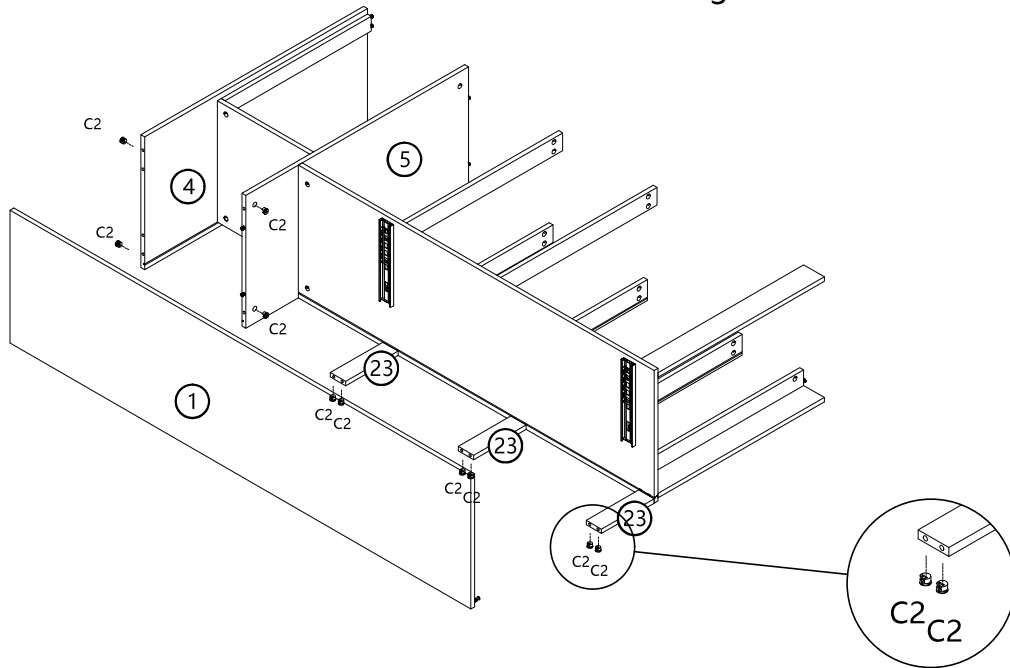

put C2 on board

④ ⑤ ②③



C2*10

12

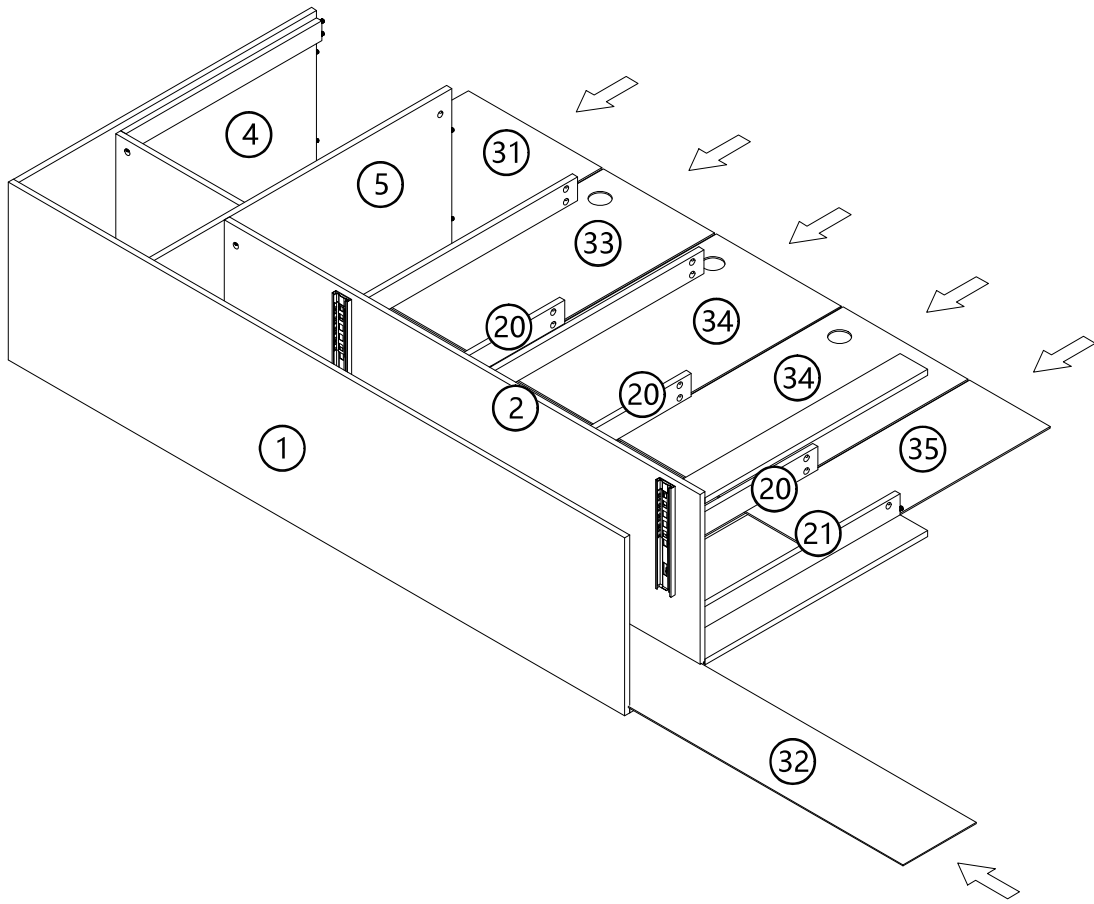

13

Make sure the arrow on the screw align to the hole on the side.

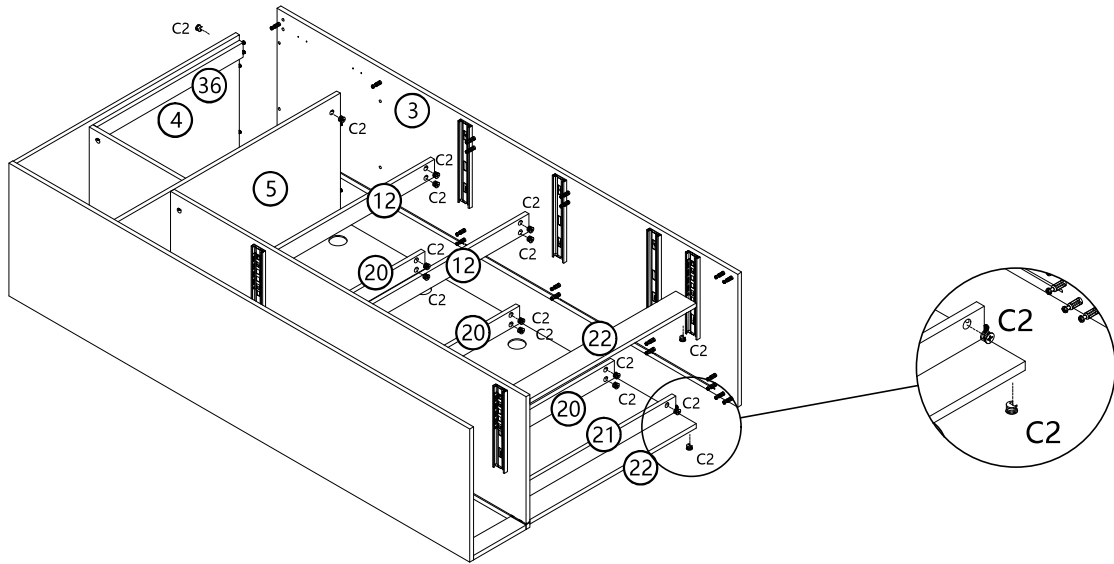

put C2 on board

④ ⑤ ⑫ ⑳ ㉑ ㉒



C2*19



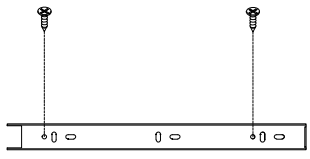
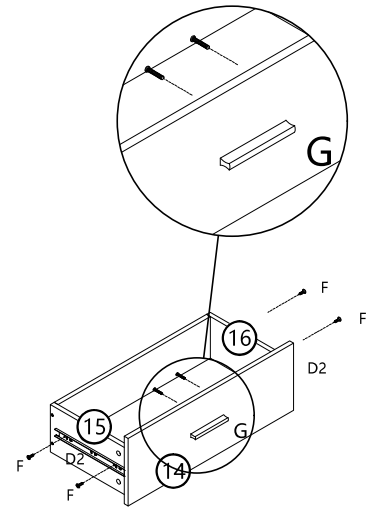
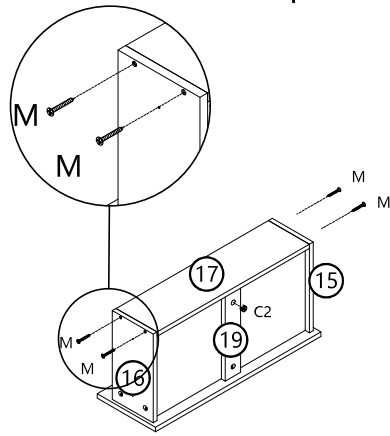
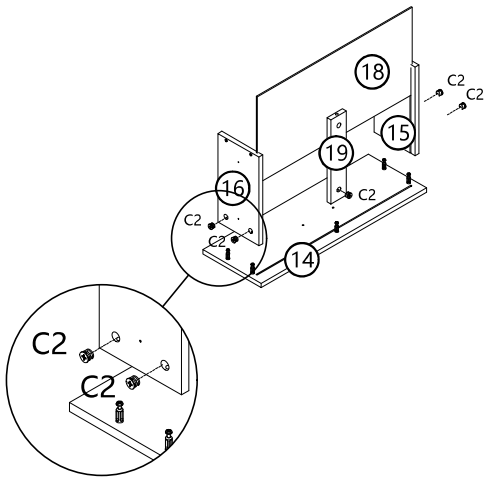

14

Make sure the arrow on the screw align to the hole on the side.

put C2 M F D2 on board 15 16 19



put G on board 14

	M*4
	G*1
	F*4
	D2*2
	C2*6

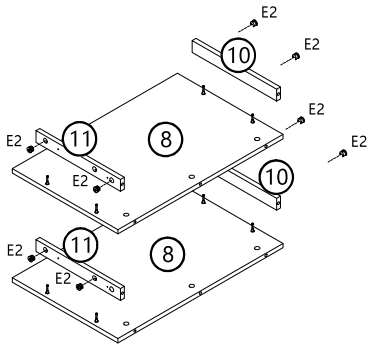

15

Make sure the arrow on the screw align to the hole on the side.

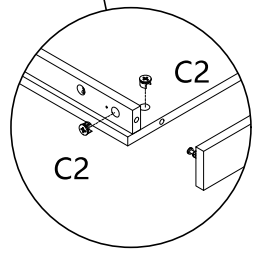
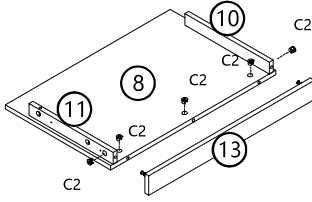
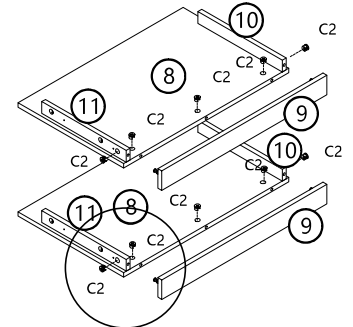
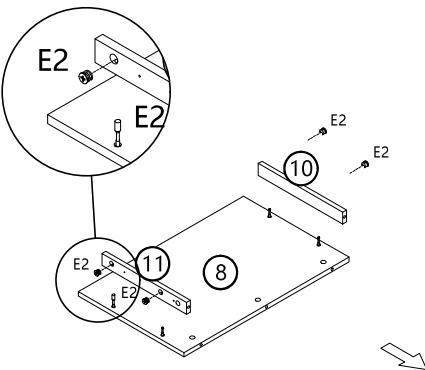

put C2 E2 on board ⑩ ⑪





	E2*12
	C2*15

16

put D2 B on board

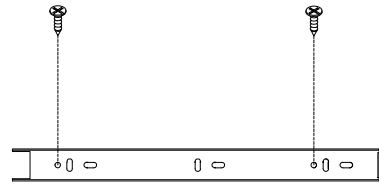
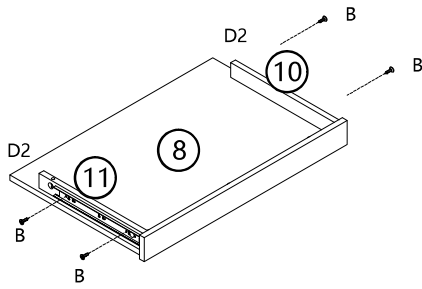
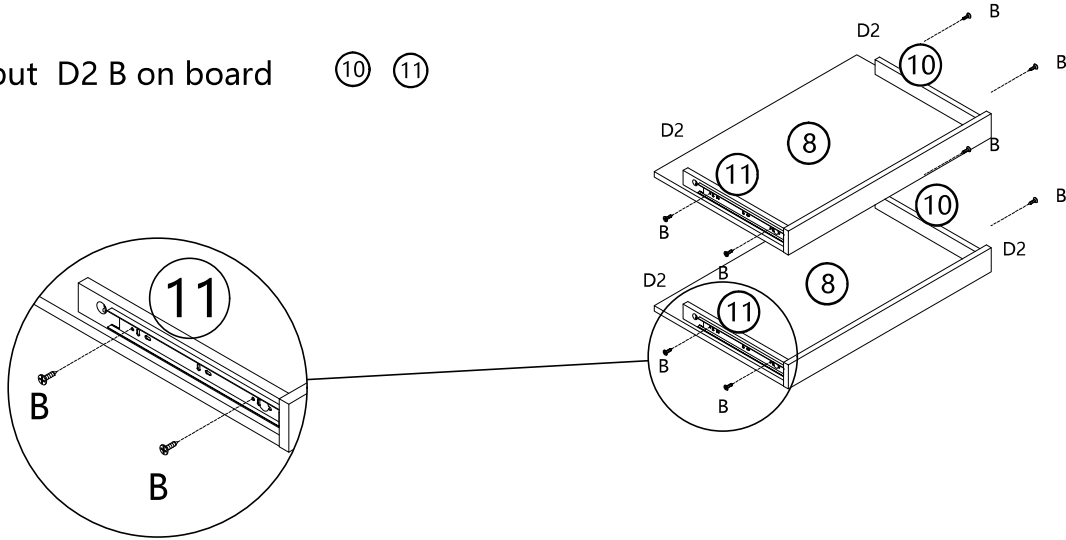
10 11



	D2*6
	B*12

17

put O on board

4

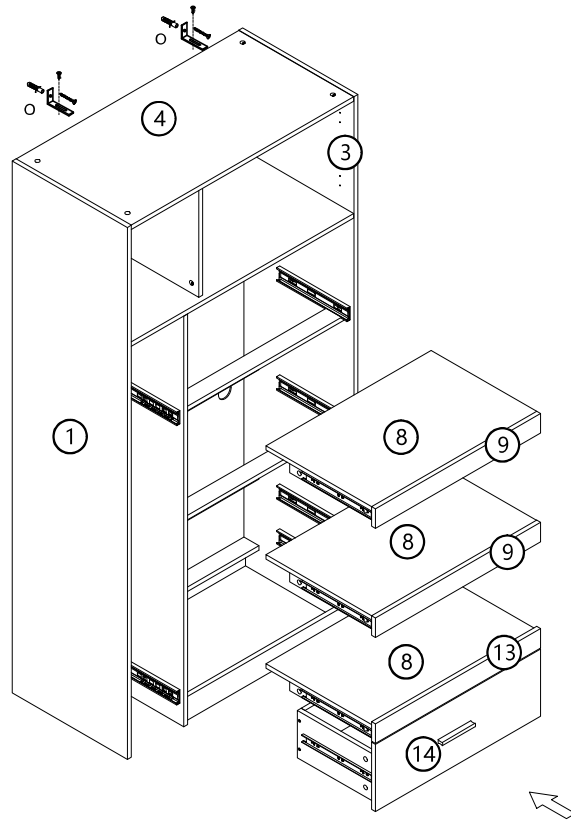
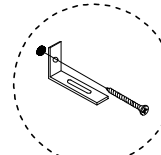
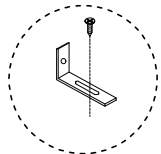
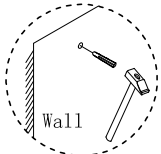
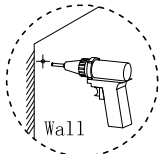

O*2

18

Make sure the arrow on the screw align to the hole on the side.



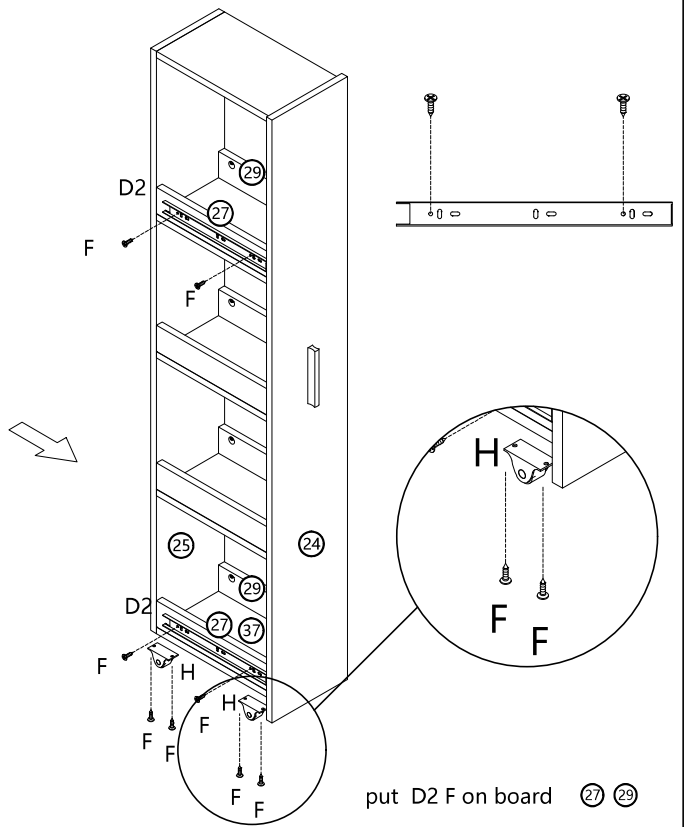
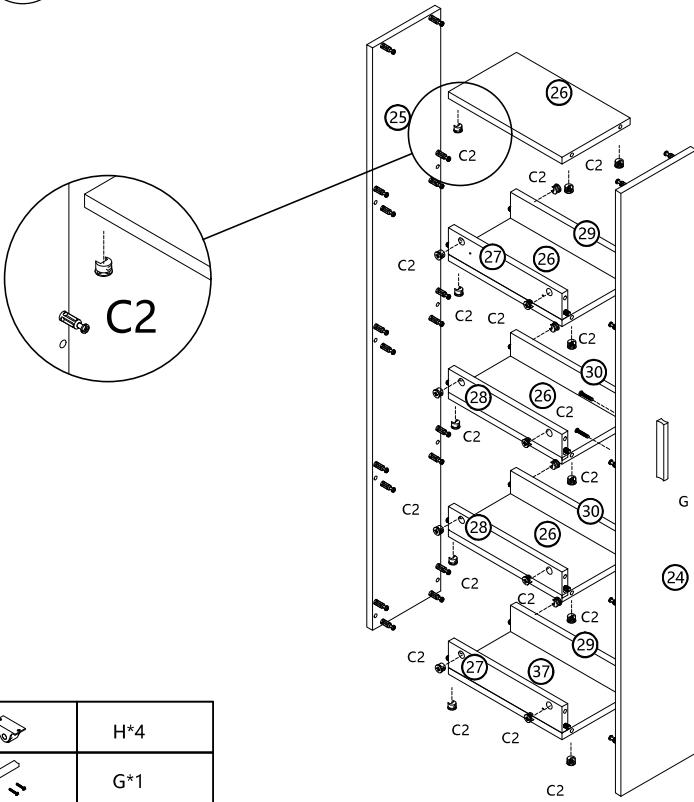

put C2 on board 26 27 28 29 30 37

put G on board 24



put D2 F on board 27 29

put H F on board 37

	H*4
	G*1
	F*16
	D2*4
	C2*36

19

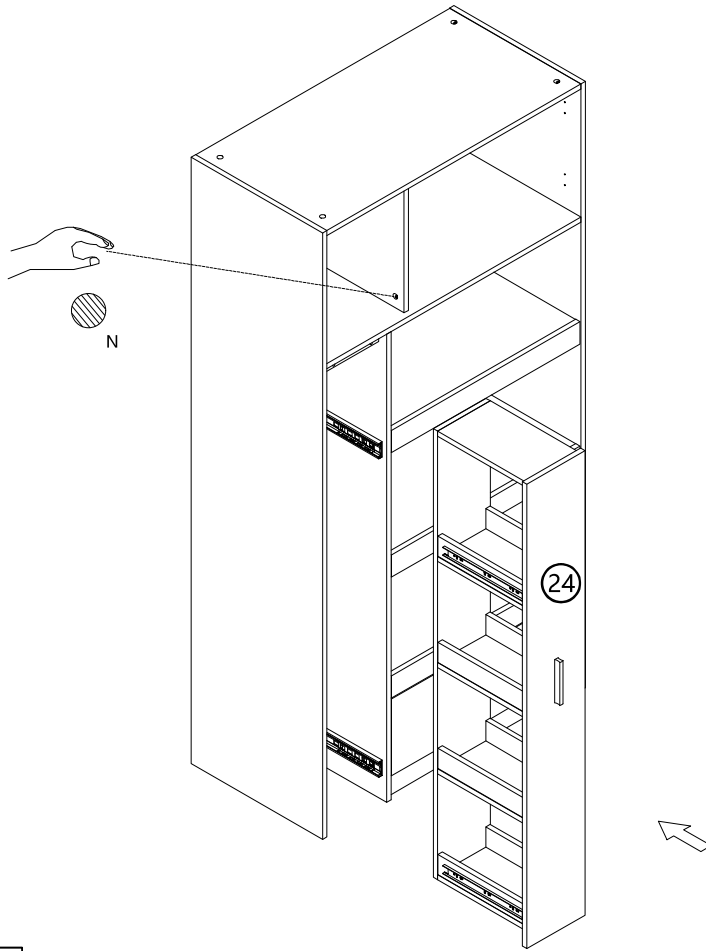



N*125

20

put L on board

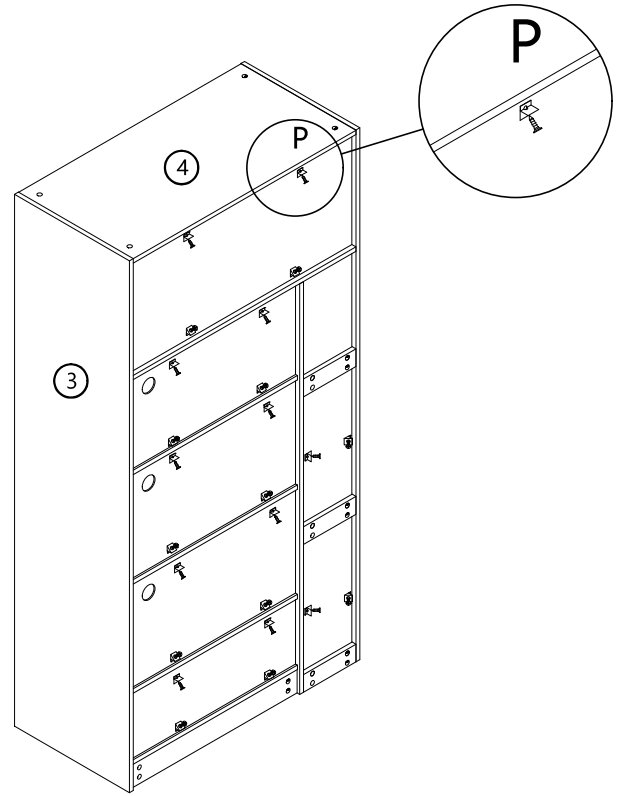
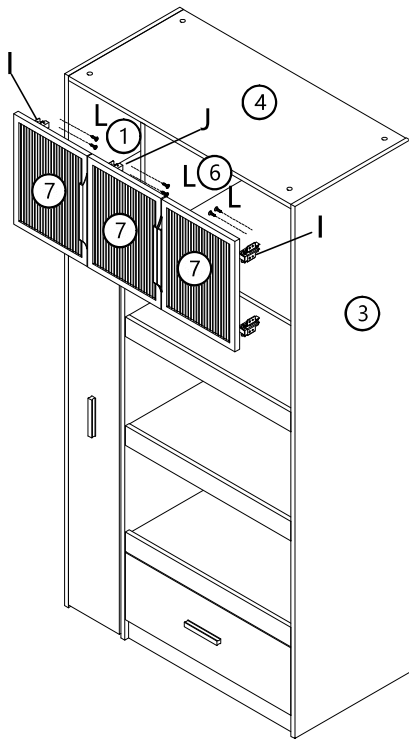
① ③ ⑥



	P*24
	L*24

END