

INSTALLATION

Product Manual

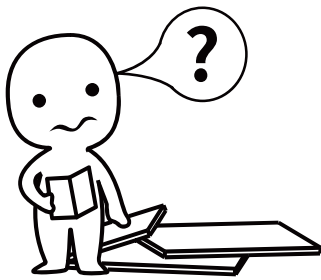

IMPORTANT INFORMATION!

please read the entire manual before starting to assemble and/or using this product. follow the manual thoroughly and keep it for further reference.

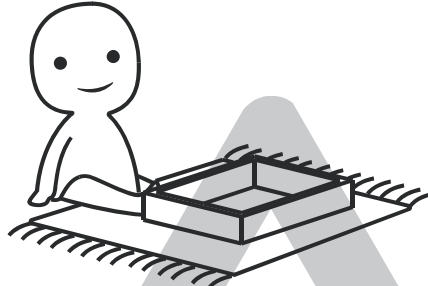
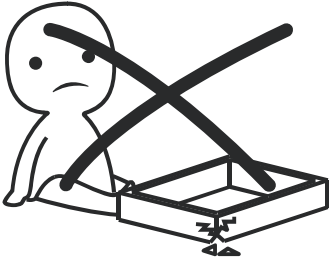

AVOID SCRATCHES!

In order to avoid scratching this furniture should be assembled on a soft layer- could be a rug.

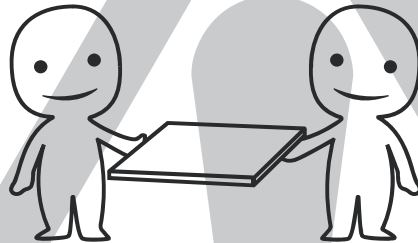

IMPROVE EFFICIENCY !

Try to find a partner to install with you, which can speed up the installation efficiency and shorten the time.

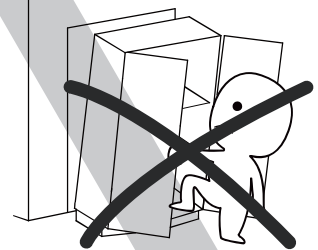
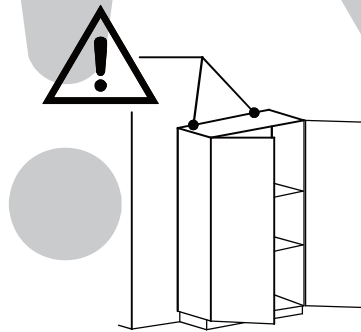
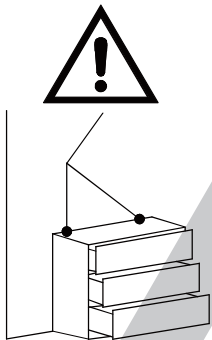

ANTI-TOPPLE WARNING !

Overturnd furniture can cause serious or fatal crush injuries. To prevent tipping over, be sure to use the wall attachment, if not included with this product. Please purchase the wall attachment that fit your wall. If unsure, seek professional advice. Please read and follow each step of the instructions carefully.

IMPORTANT !

It is important that any product which is assembled using any kind of screw is re-tightened 2 weeks after assembly, and once every 3 months - in order to assure stability through-out the lifespan of the product.

For regular maintenance and cleaning of the product, for the frame, please use a rag dipped in neutral detergent to fully wipe it, and then dry it with a clean rag. For glass materials, wipe with a rag dampened with water glass cleaner, and then dry with a dry rag.



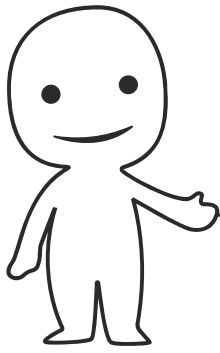



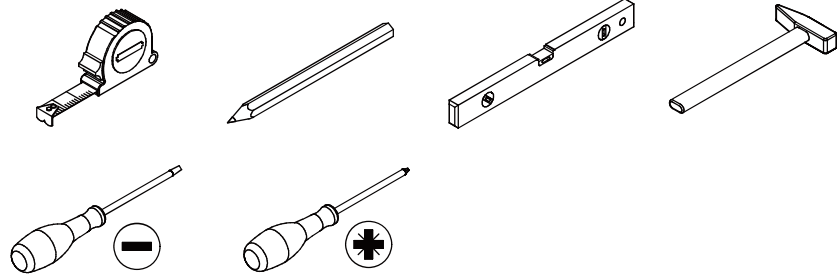



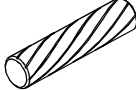
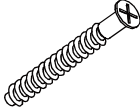

Do not use an electric screwdriver, and do not use too much force when installing, because the board is easy to break.



Please prepare the following tools

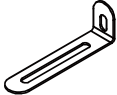

When installing, please carefully confirm whether each screw corresponds to the manual, accessories with similar shapes can be distinguished by size

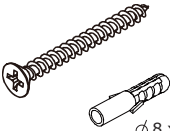
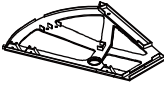
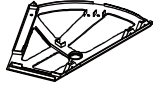
<p>A x 4</p>  <p>∅ 6 x 30 mm</p>	<p>B x 16</p>  <p>∅ 5 x 40 mm</p>	<p>C1 x 4</p> 	<p>C2 x 4</p> 
<p>C3 x 4</p> 	<p>D x 24</p>  <p>∅ 3.5 x 14 mm</p>	<p>E x 4</p>  <p>∅ 3.5 x 12 mm</p>	<p>F x 4</p>  <p>∅ 4 x 16 mm</p>
<p>G x 2</p> 	<p>H x 4</p>  <p>∅ 1.5mm</p>	<p>I x 8</p>  <p>∅ 3 x 12 mm</p>	<p>J1 x 1</p> 
<p>J2 x 1</p>  <p>∅ 4 x 12 mm</p>	<p>J3 x 1</p>  <p>∅ 8 x 38 mm ∅ 3.5 x 35 mm</p>	<p>L x 2</p> 	<p>R x 2</p> 

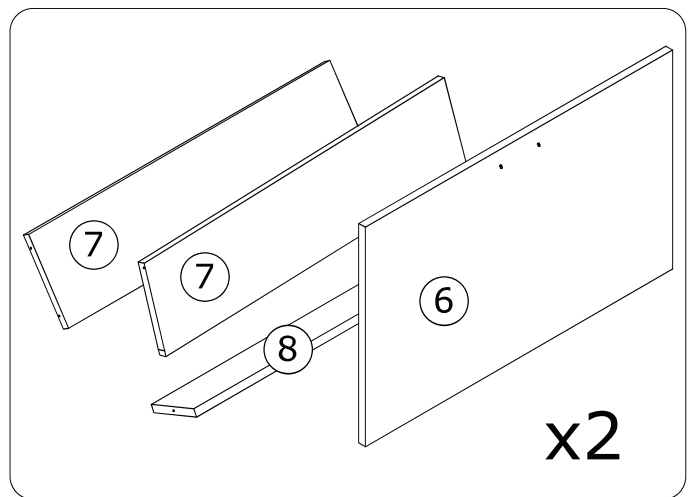
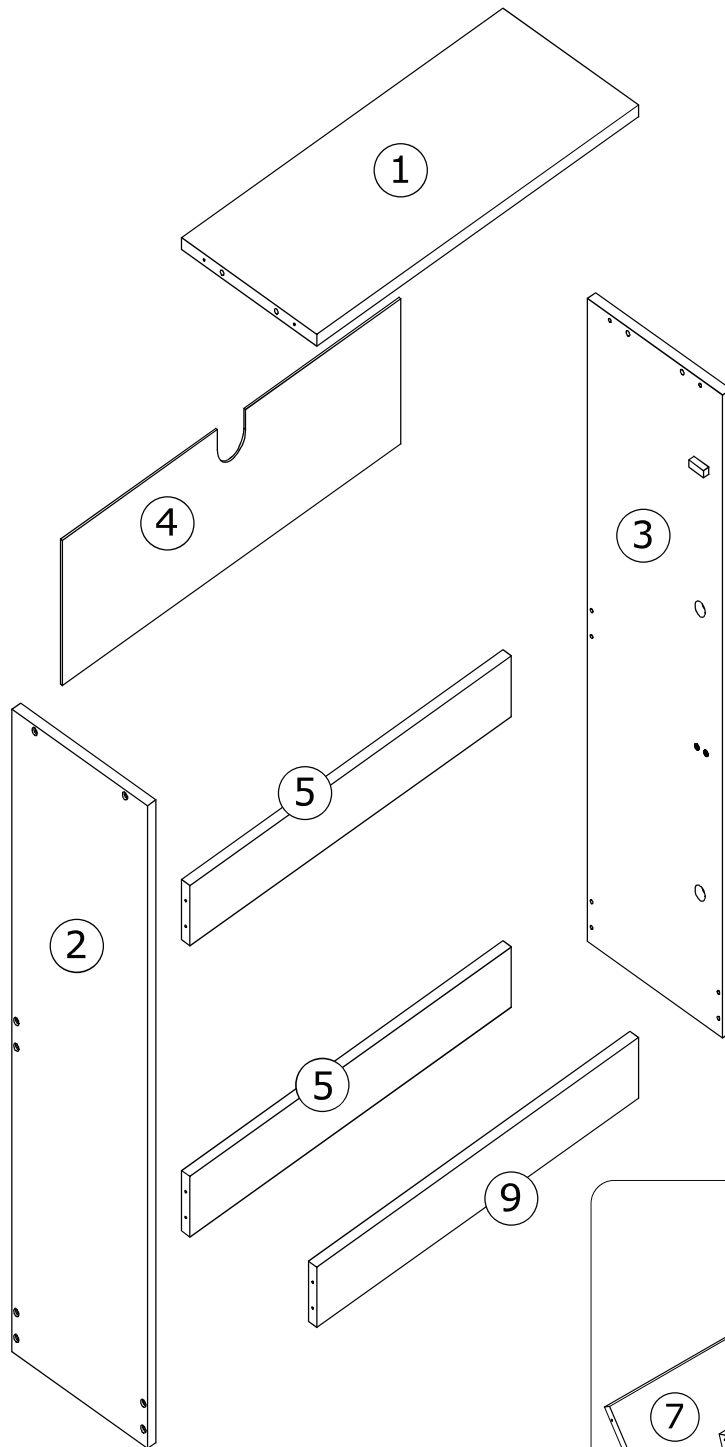

⚠ WARNING



Children have died from furniture tipover. To reduce the risk of furniture tipover:

- ALWAYS install tipover restraint provided.
- NEVER put a TV on this product.
- NEVER allow children to stand, climb or hang on drawers, doors, or shelves.
- NEVER open more than one drawer at a time.
- Place heaviest items in the lowest drawers.

*This is a permanent label.
Do not remove!*

1

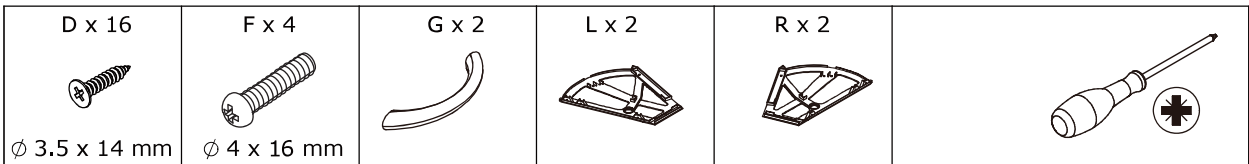

Fix plastic part L&R to panel 8, use screw D to tighten.

Attach this part to panel 6 using screw D to corresponding holes as shown.

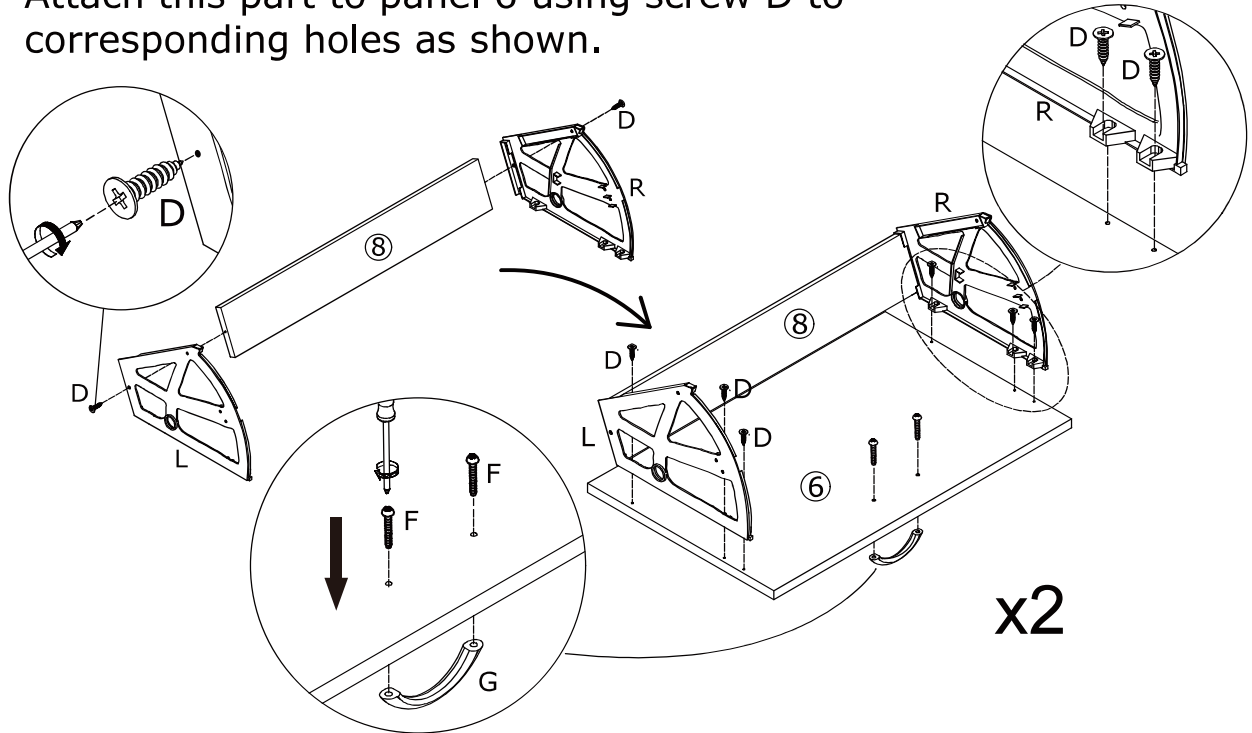

2



Attach panel 7 to the assembled part using screw D slightly to tighten, as shown.

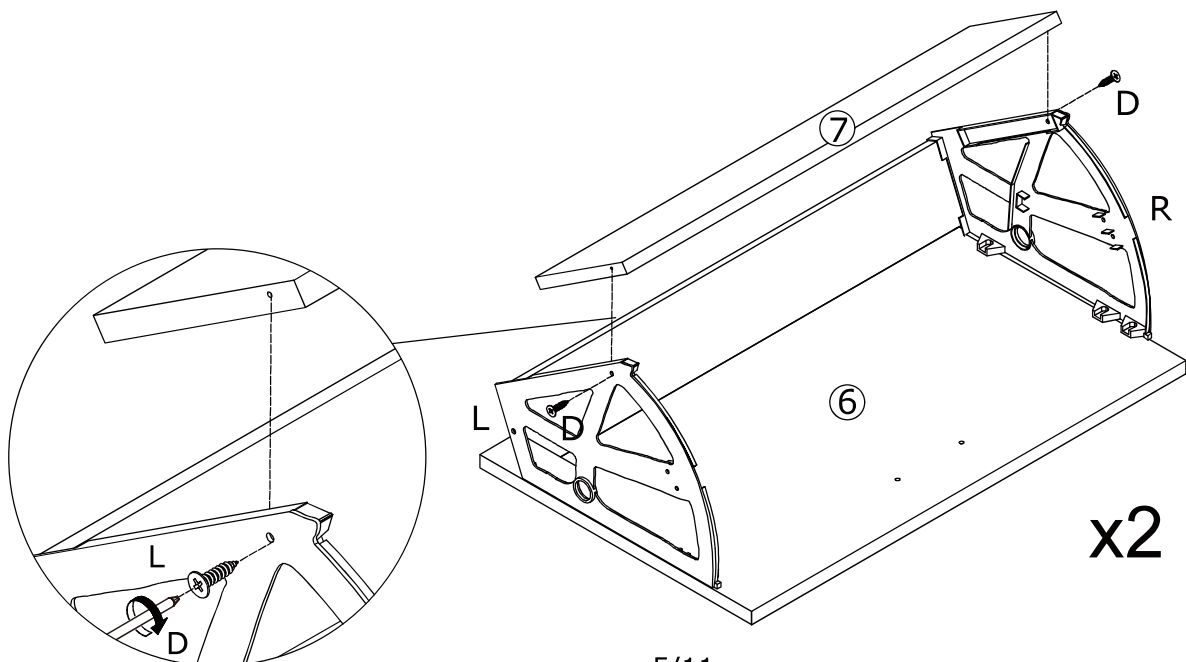
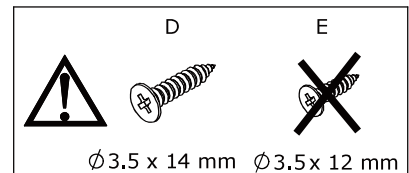

3

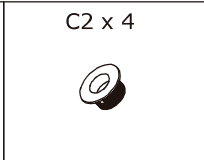
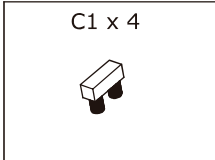

Hammer C1 & C2 slightly into the holes on panel 2 & 3, Note do not tilt to avoid damage.

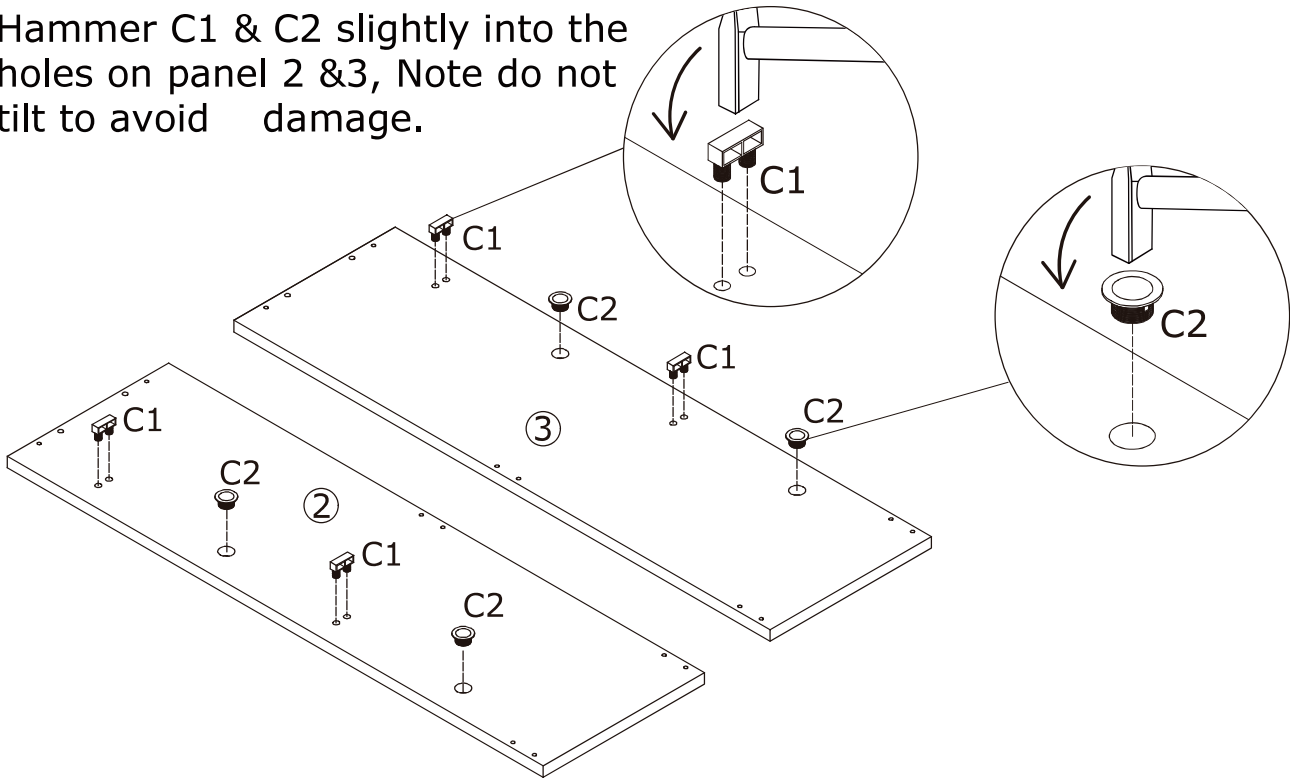

4

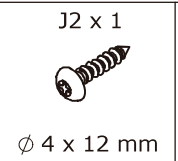
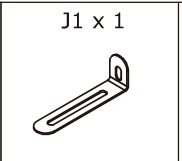
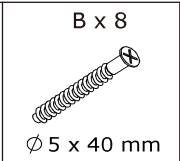
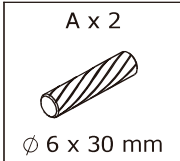

Fix part J1 to panel 1 using screw J2. Connect panel 1 with panel 3 using wooden dowels A at first. Then use screw B to tighten, as shown.

Attach panel 5 and 9 to panel 3 using screw B as well.

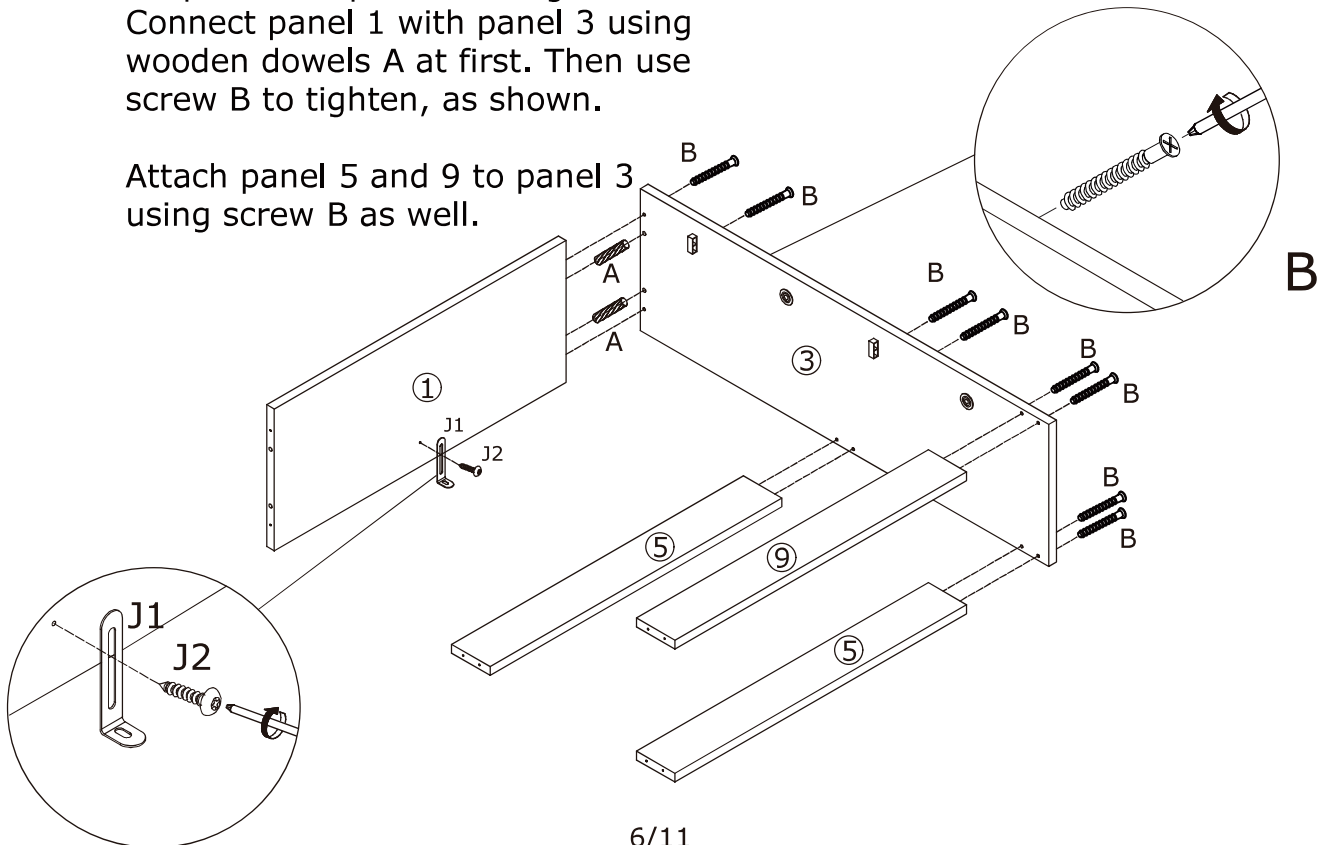

5

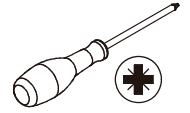
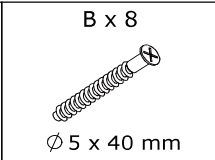
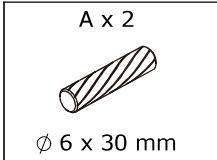

Attach panel 2 to assembled part in step 4, using screw B and wooden dowels A as shown.

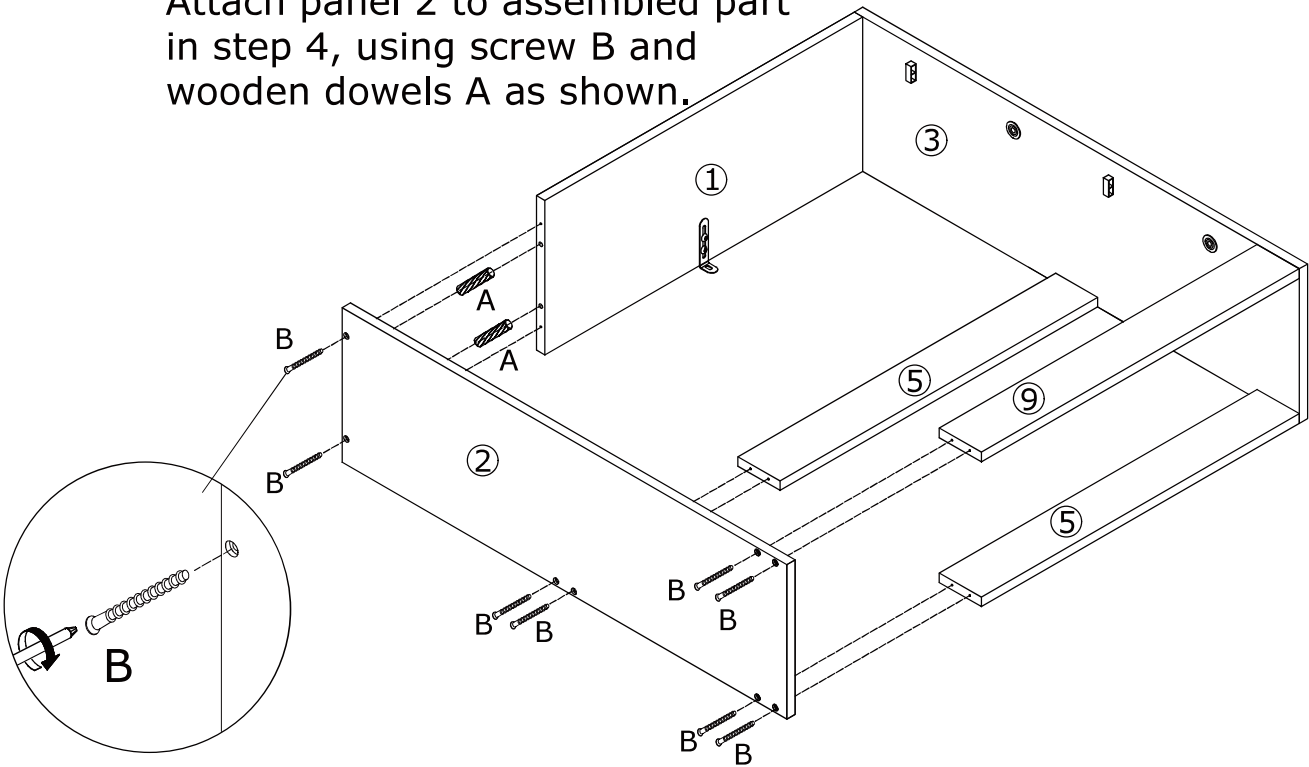

6

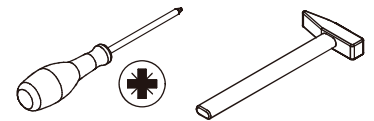
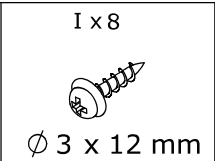
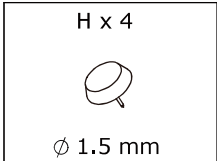

Fix panel 4 to the back of assembled unit using screw I to pre-drilled holes as shown.

Fix part H on the bottom.

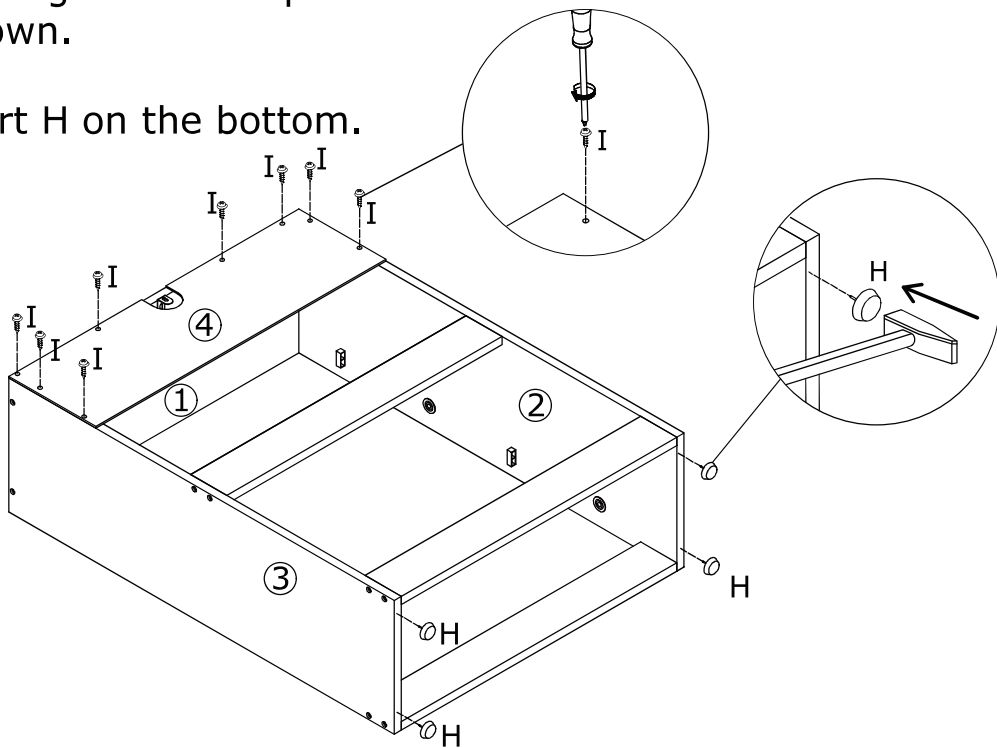

7

J3 x 1
Ø 8 x 38 mm
Ø 3.5x 35mm

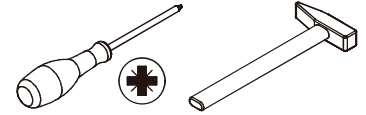

Find a proper height, fix J3 to wall as shown.

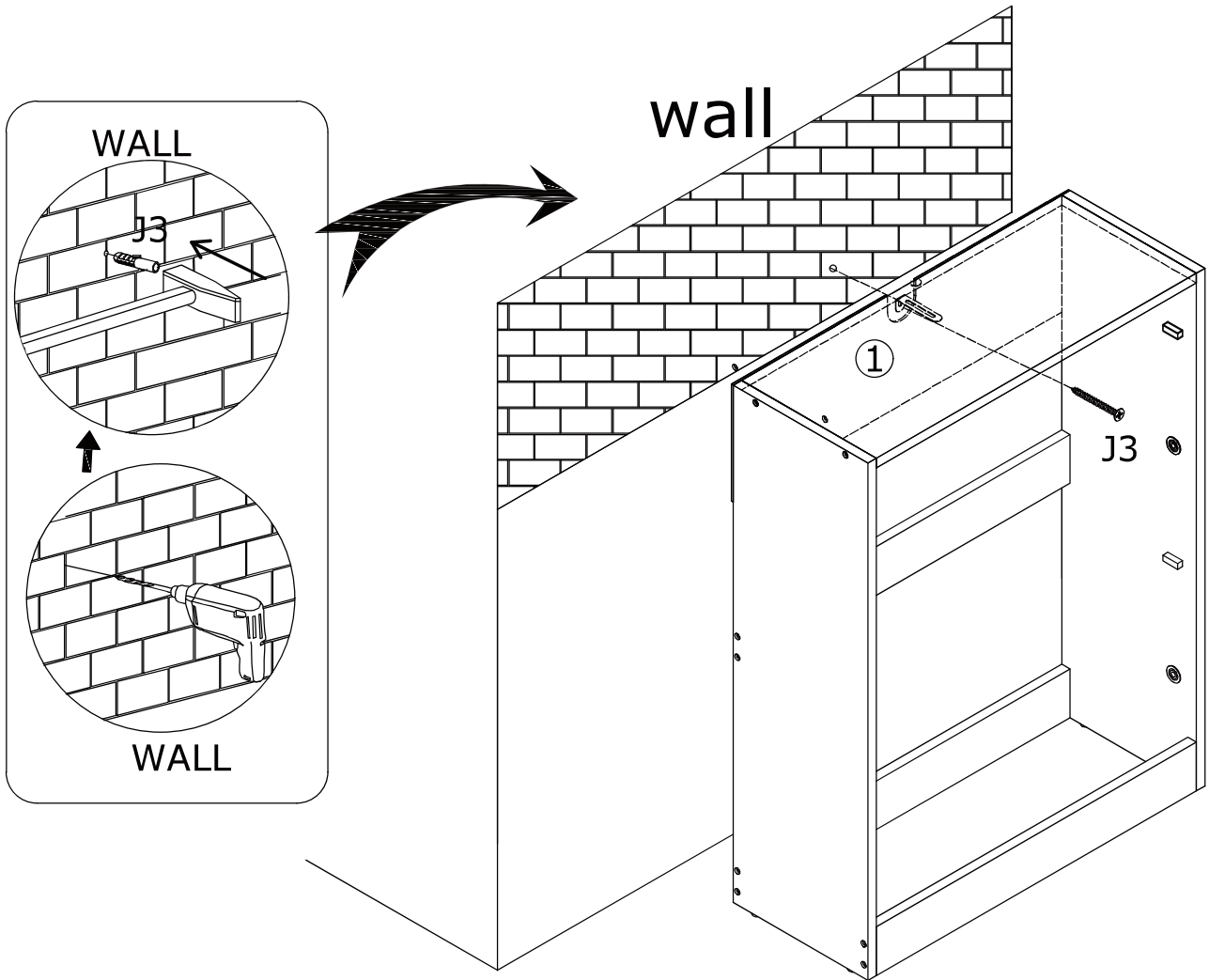

8

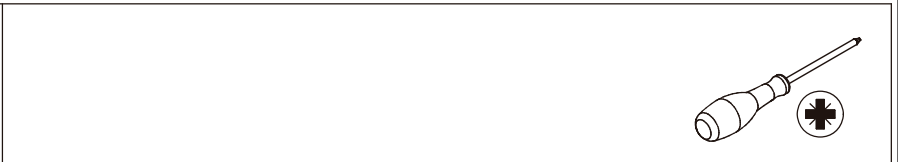
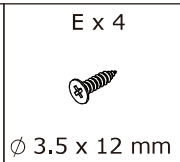
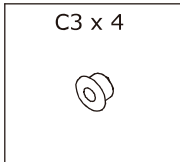

Fix the plastic part L&R to panel 2&3 by using C3 slightly. Then screw E to tighten.

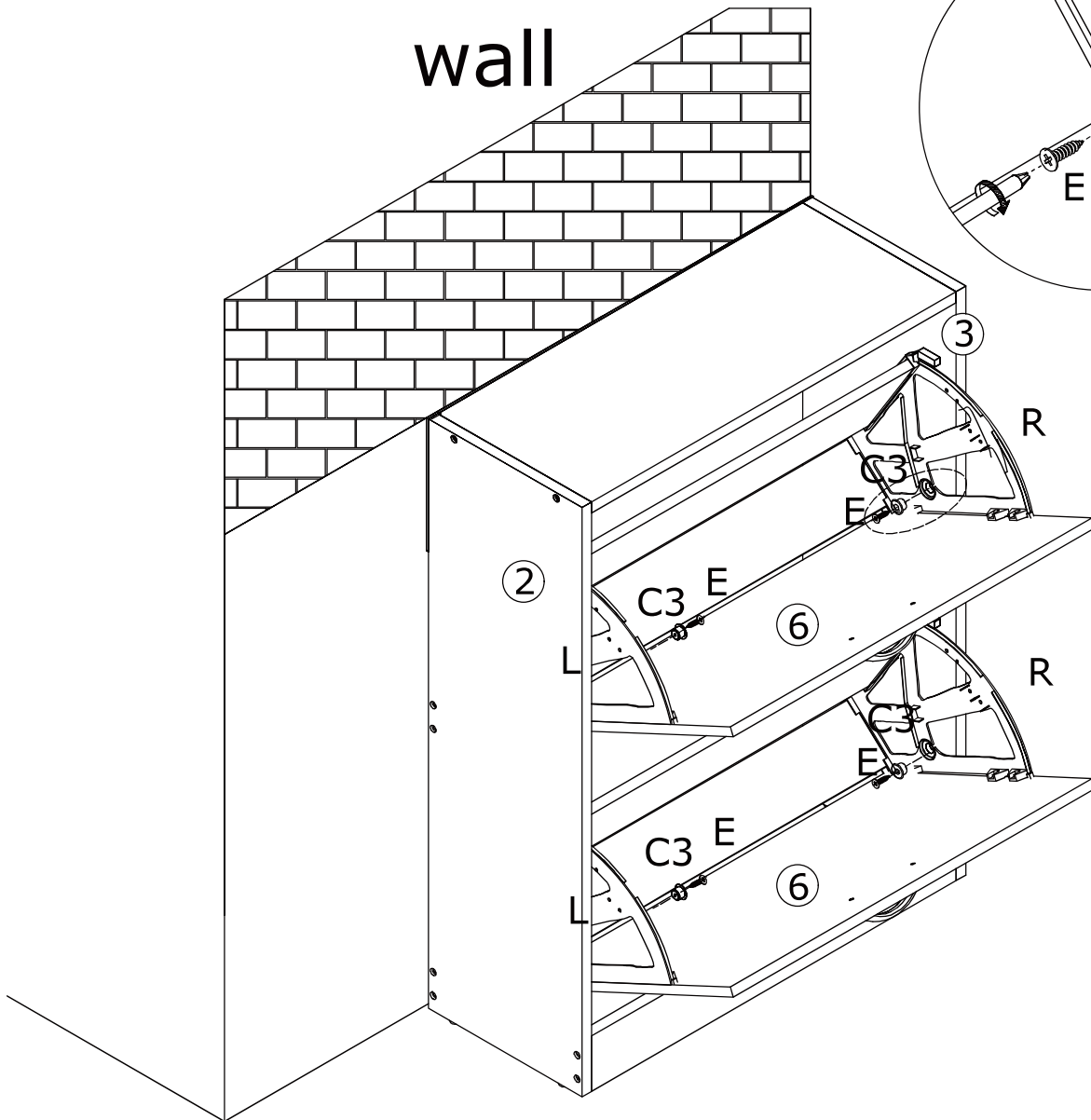
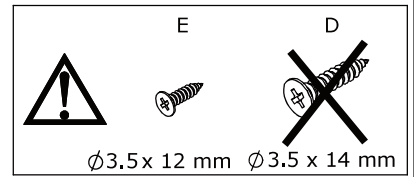

9

Insert panel 7 to the middle of drawers

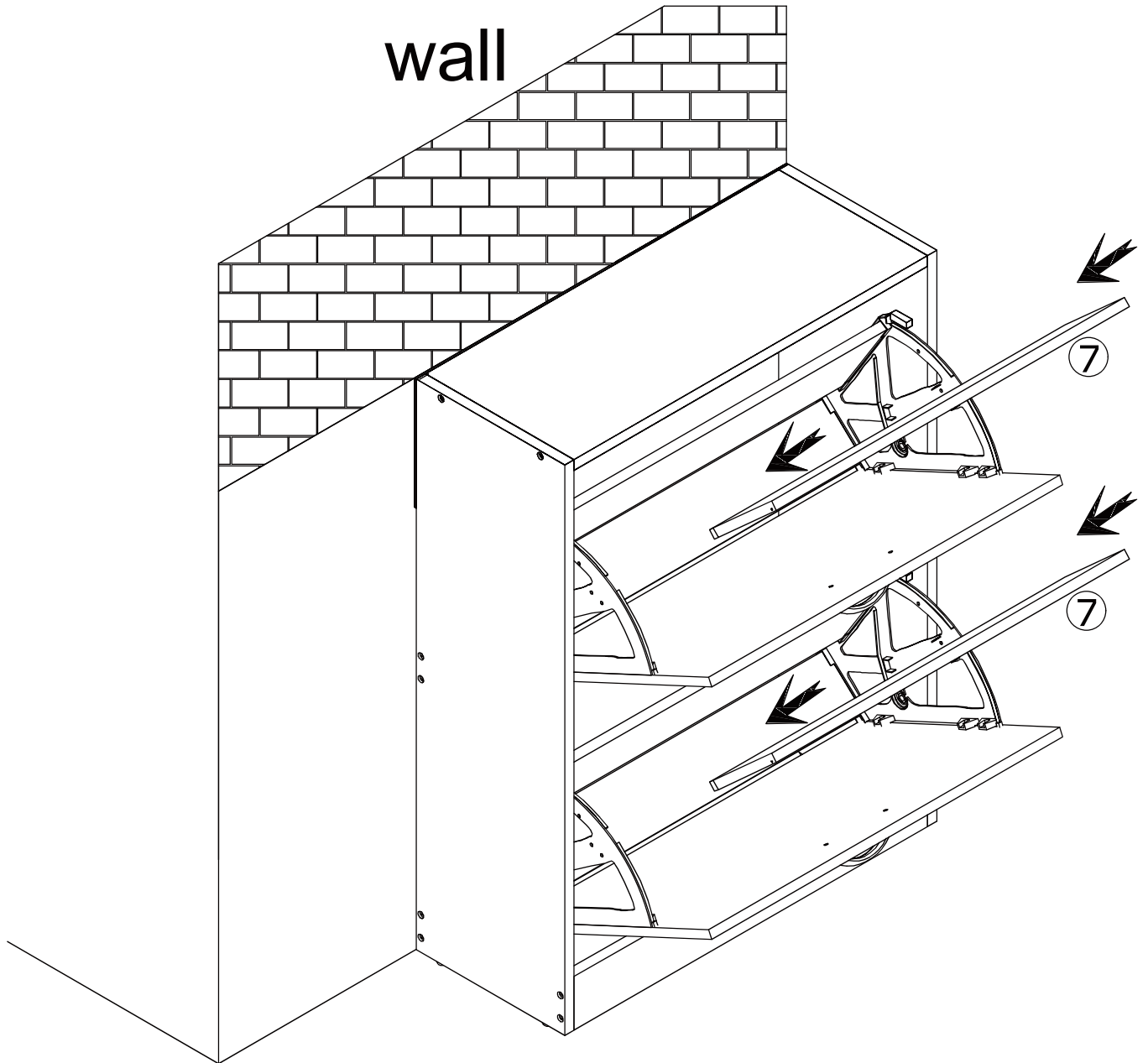

10

D x 4
Ø 3.5 x 14 mm

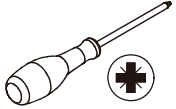

Using screw D to fix panel 7 to both side plastic part as shown.

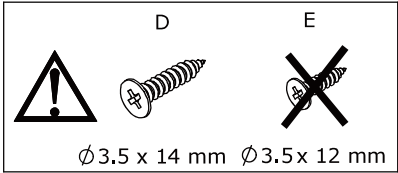

wall

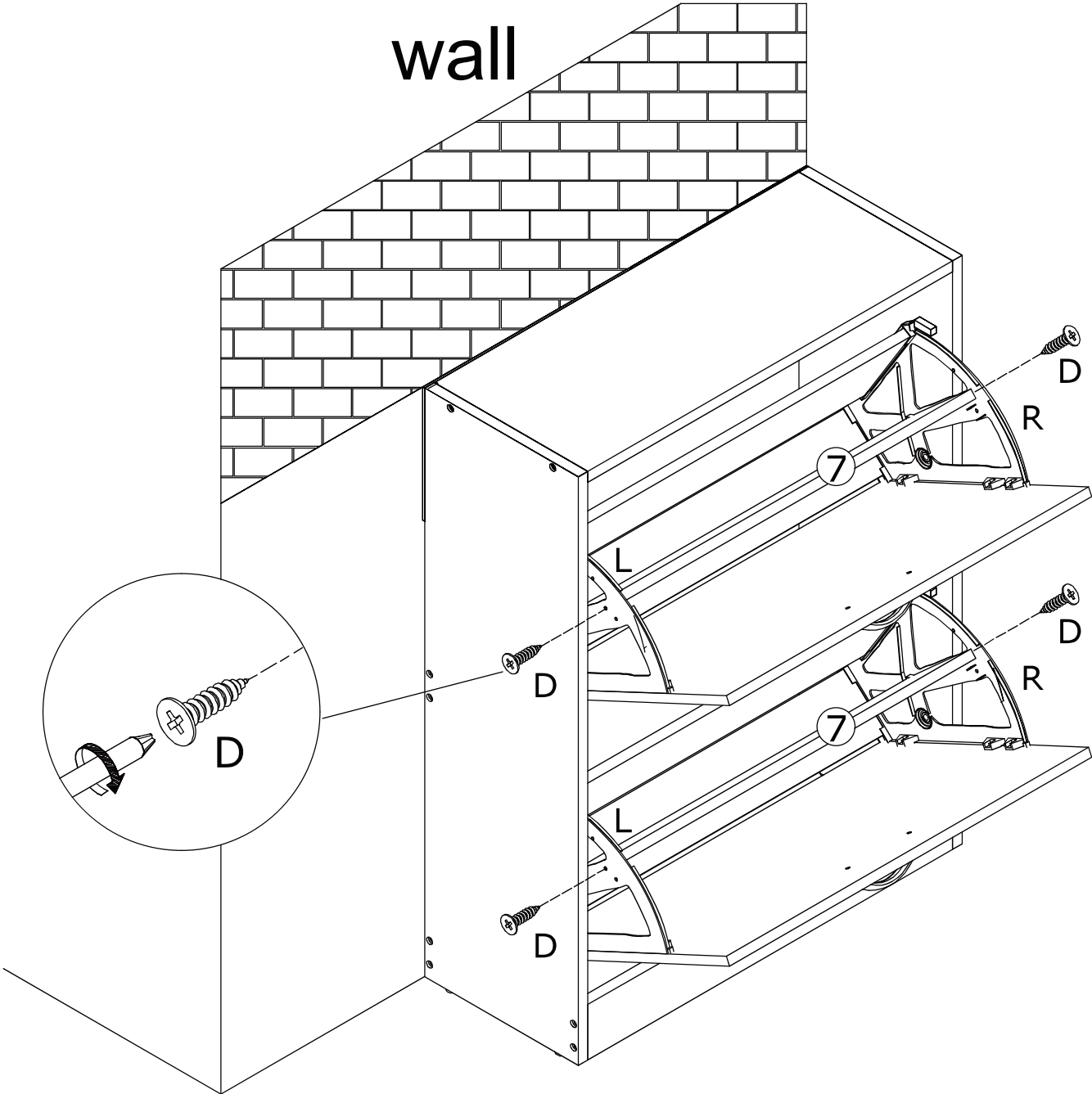

WARRANTY

WARRANTY CLAIMS

- There is a 30-day warranty for broken furniture or any other problems that do not work properly. The warranty will start from the date of purchase which must be verified by proof of purchase.
- Before making a claim, we may be able to answer your query, simply call us. Please leave your purchase order number, along with some details of the problem, if you want a replacement part. We will arrange within 48 hours. If there is out of stock, we will reply with a shipping date.
- The product must be used in accordance with the instructions provided. For health reasons.
- For other reasons, if the furniture needs to be returned, it must be cleaned and dried and operated within 30 days of receipt.

Type of Warranty Claim

- Failure to follow the furniture instructions will invalidate the warranty. Attention please.
- Does not include damage during installation, but includes damage during transportation.

Scope of responsibility

- Shall not bear any responsibility for misuse or user damage and / or loss of parts during the installation of furniture.
- After using, the damage and scratches of the furniture are not covered by the warranty.

The Warranty Relates to All Bought in The Us and Covers The Following Areas

- Sheet parts: 1 month from the date of purchase.
- Electrical parts: 1 month from the date of purchase.