

ASSEMBLY INSTRUCTIONS



ASSEMBLY INSTRUCTIONS

ASSEMBLY TIPS:

1. Remove hardware from box and sort by size.
2. Please check to see that all hardware and parts are present prior to start of assembly.
3. Please follow attached instructions in the same sequence as numbered to assure fast & easy assembly.



WARNING!

1. Don't attempt to repair or modify parts that are broken or defective. Please contact the store immediately.
2. This product is for home use only and not intended for commercial establishments.

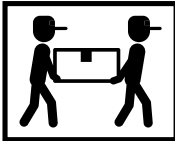

ASSEMBLY TIME 20 MINUTES



A Glass top

1PC



C Ottoman

2PCS











B BASE

1PC



D LEG

4PCS

Z HARDWARE IDENTIFICATION			
	DESCRIPTION		QTE
1	WASHER	 $\phi 38$	4 PCS
2	SCREWS	 M5x10	16PCS
3	THREADED ROD	 M8x190	4 PCS
4	NUT	 M8	8 PCS
5	BOLT	 M8x25	4 PCS
6	METAL TUBE	 $\phi 38 \times 160$	4 PCS
7	FLAT WASHER	 8x18x1.5	8 PCS
8	ALLEN WRENCH	 #5	1 PC
9	WRENCH	 #8	1 PC

ASSEMBLY INSTRUCTIONS

STEP 1

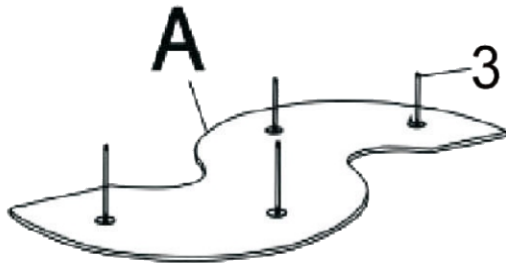

STEP 2

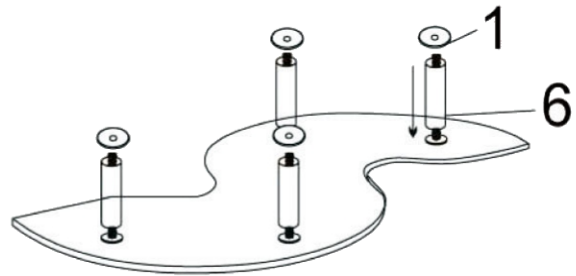

STEP 3

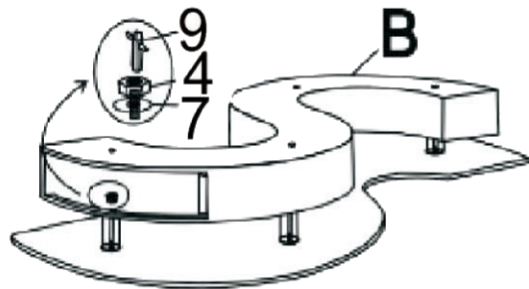

STEP 4

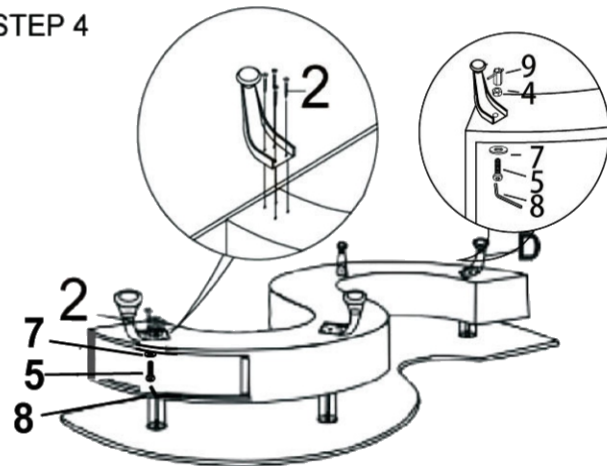

STEP 5

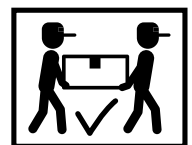
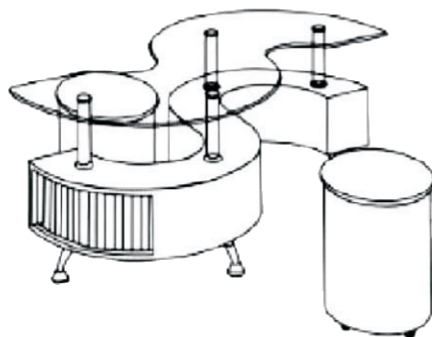

ASSEMBLY INSTRUCTIONS

