

# INSTALLATION INSTRUCTION

## PEDESTAL SINK

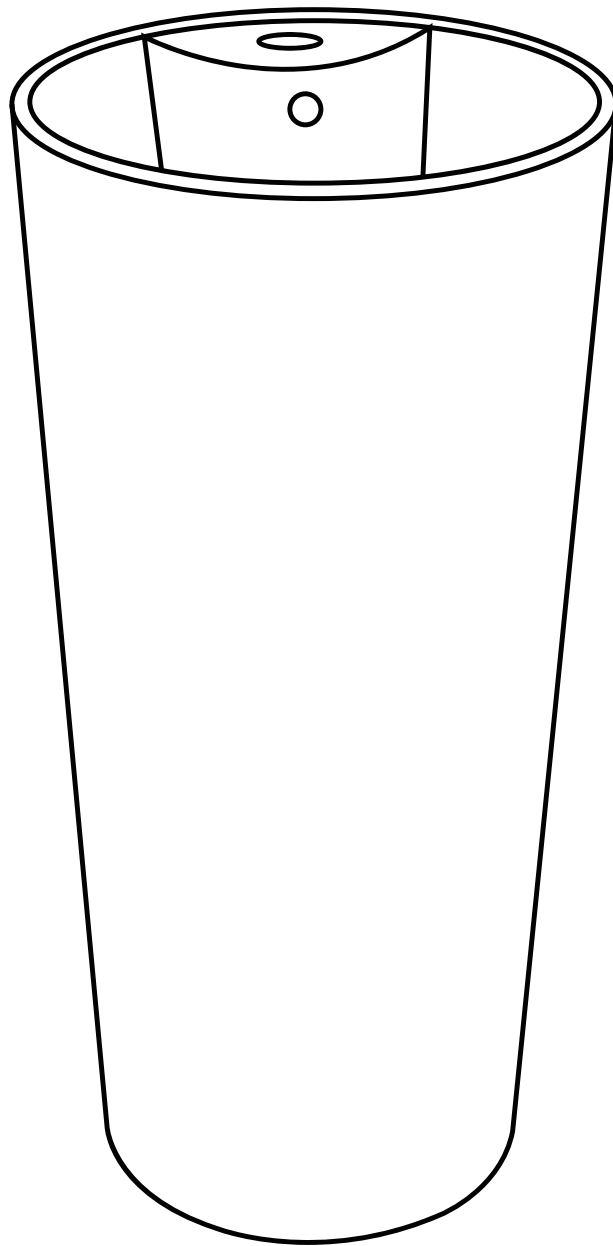



## PRIOR TO INSTALLATION

- Inspect sink to ensure no damages have occurred while in shipping.
- Observe all plumbing and building codes in accordance with your state and local requirements.
- All dimensions are nominal! Be sure to measure your sink prior to installation.
- The step-by-step guidelines in the installation instructions are a general reference. Should there be any discrepancies, Swiss Madison cannot be held liable. It is recommended to install all Swiss Madison products by hiring a licensed professional.
- Read installation and maintenance instructions thoroughly before installing. Be sure to use proper tools and always wear proper personal safety accessories for your protection.
- Two people are recommended to handle and install this product as it is fragile.

### SUGGESTED TOOLS & MATERIALS:



Safety Glasses



Pencil



Wrench

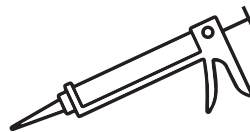

Caulk



Silicone

# PRODUCT SIZE

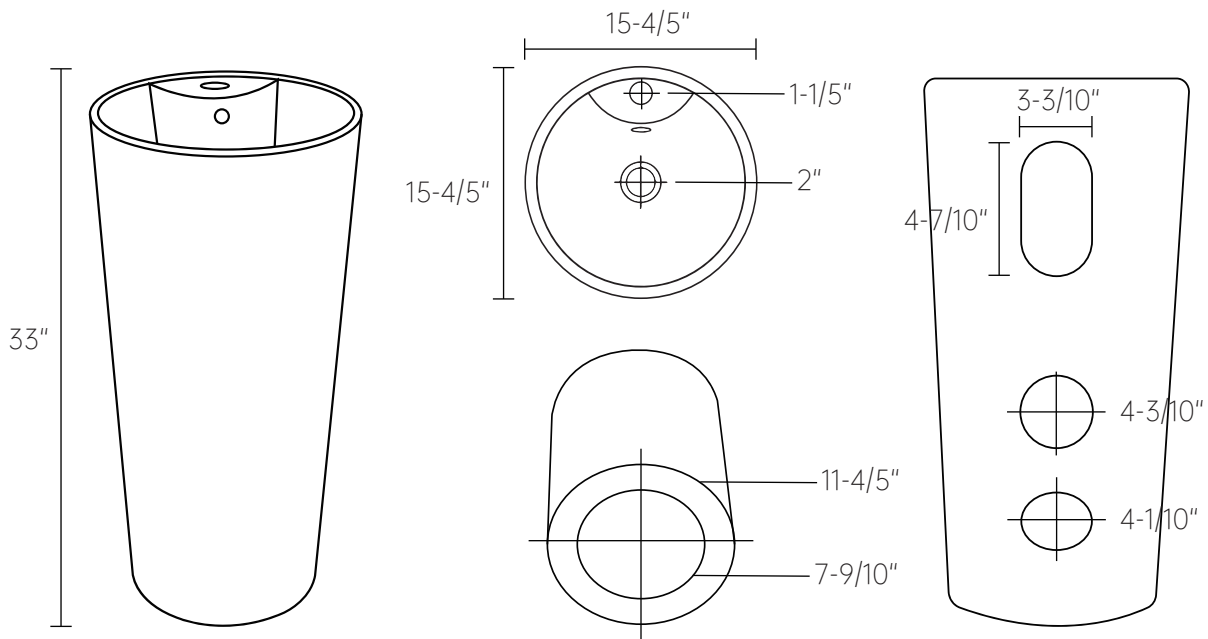

1. Read the complete instruction manual before beginning installation.
2. Confirm that your model will fit in intended location and plumbing fixtures are located where legally required before beginning installation.
3. Not all drawings on this manual are drawn to scale. Please refer to the model chart.
4. Two people are recommended to install and move this product.

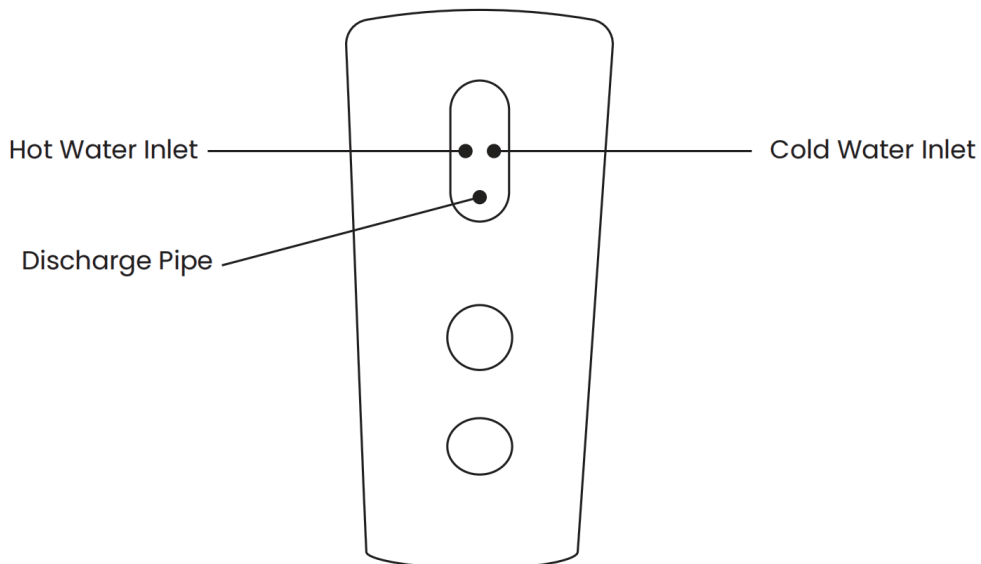

# INSTALLATION INSTRUCTION

## 1. Verify Sink Location

Using a pencil mark the location where you want the sink to be onto the floor.

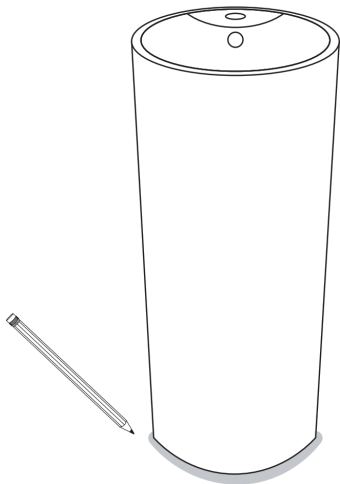

## 2. Connect Pipes

- Install waste and overflow into sink basin.
- Screw plumbing pipes into basin. Plumbing not included.
- 1 1/2" Discharge pipe location varies between models and may need to be re-plumbed before installation.

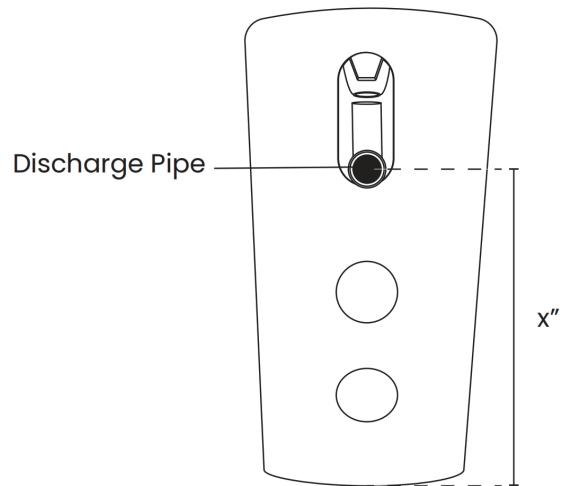

## 3. Connecting Plumbing

- We recommend installing faucet (not included) while back of sink is accessible.
- Align pipes in basin to plumbing in wall.
- Tighten into place, with clockwise motion.
- Water shutoff valve should be slightly above the 1 1/2" drain line coming out of the wall.

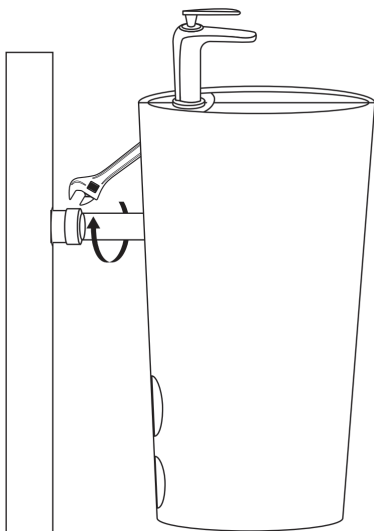

## 4. Seal Sink - 2 People Required

- Dry fit pedestal sink before final installation.
- Person 1- Slightly tilts sink back, so basin just barely lifts off ground. Person 2- Apply construction adhesive underneath the sink. Then both gently lower basin back to standing position.
- Caulk the sink to the floor with silicone or sealant. Do not use sink until 24 hours after sealing.

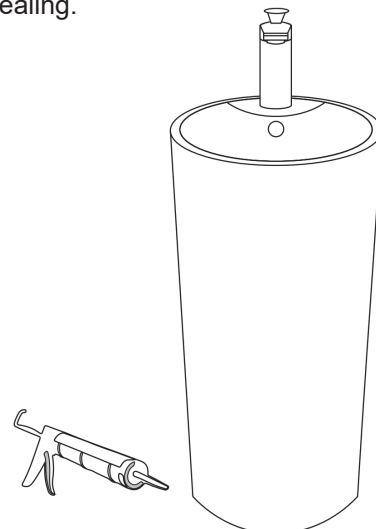

# LIMITED WARRANTY COVERAGE

## 1 YEAR LIMITED WARRANTY

Our products are made of high quality materials and superb craftsmanship to provide our customers with durable products. Within one year after delivery, if any part or workmanship is found to be defective upon inspection under normal use, we will furnish, without charge, replacement parts or, at our option, replacement of any product or portion of a product deemed defective under normal installation, use, service and maintenance. This warranty applies only to the original purchaser. Proof of purchase is required for claims. Scratches are not covered by the warranty.

The manufacturer warrants this product to be free of manufacture defects during the above mentioned warranty time. Please keep a copy of the original invoice as proof of purchase.

We will, as its option,(1) repair or replace the defective part(s) or product(s) at no charge, (2) issue a refund of the original purchase price of the product(s) (Valid within 30 days from the date of purchase); or (3) issue a credit to be applied toward the purchase of a new product Shipping/delivery charges may apply and are at our sole discretion.

We will, as its option,(1) repair or replace the defective part(s) or product(s) at no charge, (2) issue a refund of the original purchase price of the product(s) (Valid within 30 days from the date of purchase); or (3) issue a credit to be applied toward the purchase of a new product Shipping/delivery charges may apply and are at our sole discretion.

Our products must be installed by a fully insured and licensed plumber only. Installation of any our product by anyone other than fully insured and licensed plumber shall void limited warranty.

This limited warranty shall not apply to goods which have been subject to accident , negligence, improper installation, product abuse, product misuse, or use of cleaners containing abrasives , alcohol or other organic solvents, whether performed by a contractor, service company, or yourself, are excluded from this warranty.

Our responsibility under this limited warranty is limited to only to replacement parts and no other costs. We will not be responsible for labor charges and/or damage incurred by installation, repair or replacement, nor for any indirect incidental or consequential damages, losses, injury or costs of any nature relating to this product. Except as provided by law, this limited warranty is in lieu of and excludes all other warranties, conditions, and guarantees, whether expressed or implied, statutory or otherwise, including without restriction those merchantability of fitness for use.

## RESPONSIBILITIES OF OTHERS

Inspecting the unit prior to installation is the responsibility of the installer or building contractor who acts on behalf of the user. They are responsible for ensuring the unit is free of defect or damage. Notices are placed on and in the unit and on the shipping carton advising the installer of this responsibility. In the event of a problem, the unit must not be installed. We are not responsible for failures or damage that could have been discovered, repaired, or avoided by proper inspection and testing prior to installation.

Damage occurring in transit is the responsibility of the carrier. The user or installer MUST open the crate and inspect the unit for damage when it is delivered. If damage is discovered, it must be reported immediately to the seller and the carrier in writing, and an inspection requested. Failure of the carrier to respond should be reported to the seller and the carrier. Your freight claims should be filed promptly thereafter.

## LIMITATIONS AND EXCLUSIONS

This warranty does not cover any claim arising from abuse, misuse, negligence, accident, improper installation, or operations on the part of the purchaser. This warranty is void if the product is subject to alteration, or if repairs are attempted by anyone other than an authorized agent of ours. This warranty does not extend to plumbing or components installed by dealers, installers, or by any party other than us.

We will not be liable for loss of use of the product inconvenience, or any other incidental or consequential costs, expense or damages. Please note that some states do not allow the exclusion or limitation of incidental damages.

## DISCLAIMER

Except as expressly provided, there shall be no warranty or obligation, express or implied, oral or statutory. No dealer or other person has the authority to make any warranties or representations concerning our company or its products. In no event shall we be held responsible for any such warranties or representations.

## WARRANTY SERVICE

**NOTE:** When requesting warranty, be sure to have the following:

- Copy of original invoice
- Date of installation
- Description and pictures of defect
- Model number or description of model

To obtain warranty service and replacement part, please contact our Customer Service. We will determine whether to repair or replace your product, issue a refund, or issue a credit.