

ASSEMBLY INSTRUCTION

Friendly Reminder.

- 1.This sofa is packed in 3 boxes. Please assemble it After all boxes are received.
- 2.As the cushions are all vacuum compressed,there will be some wrinkles. Please give your cushions up to 72 hours to reach its original size and the wrinkles will basically disappear.
- 3.Please do not open the compressed packages until your sofa frame is completely assembled

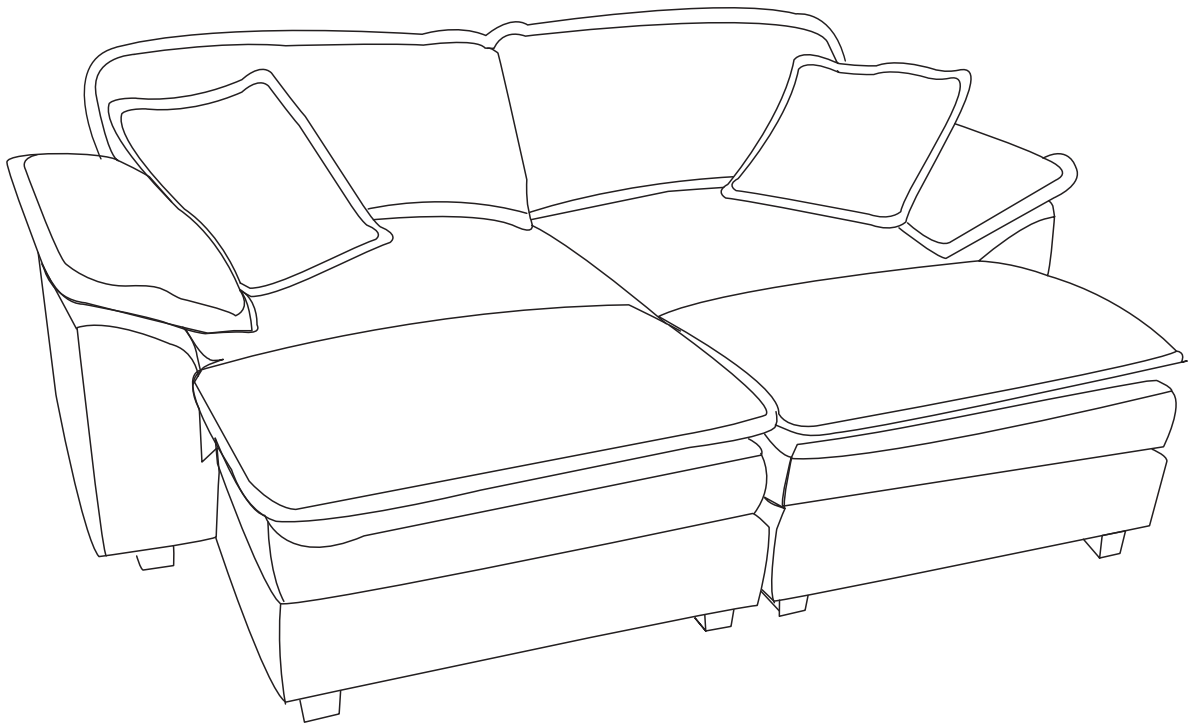

Return & Warranty policy:

- We strive to offer the highest quality products,and we also try our best to satisfy each and every customer that orders from us with replacement parts or service as needed.
- If the item is damaged or defective, please take photos as evidence for replacements and refunds.
- Please do not return to store,contact the seller if you have any troubles with this product.

All parts and hardwares

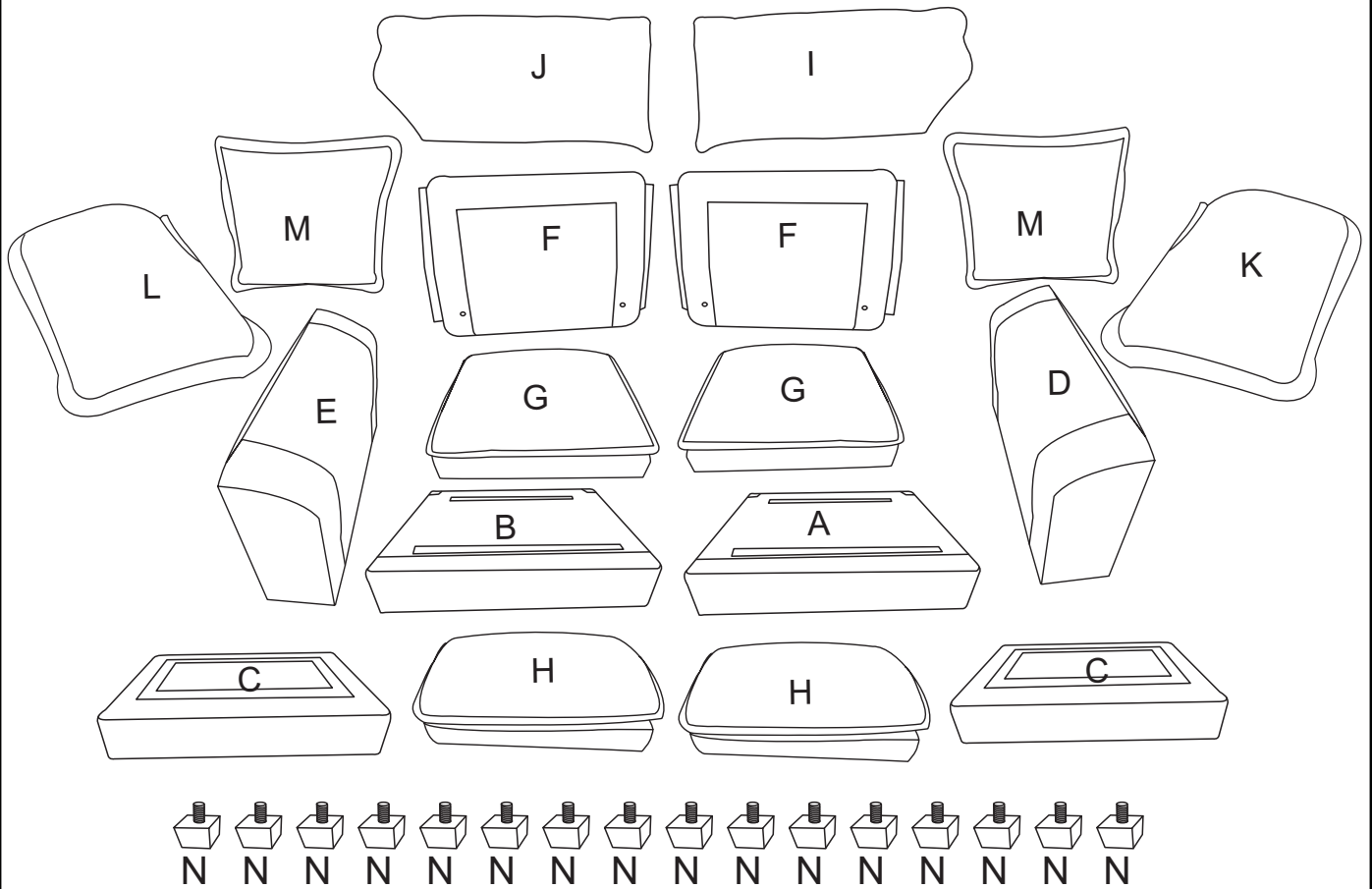

Hardware Package

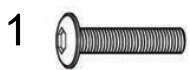

16X Screws 8X35



16x Washer



16x Gasket



1x Wrench

NOTE: Take out of all parts from 3 boxes, make sure all parts you have received before assembled.

COMPONENTS

BOX 1

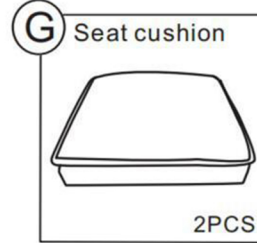
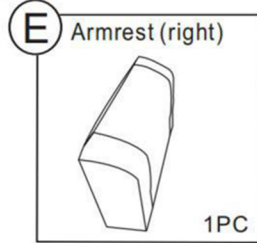
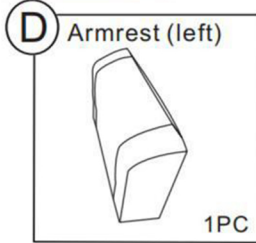

BOX 2

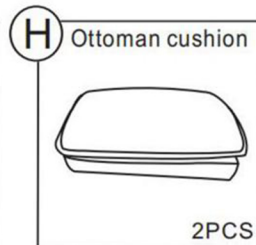
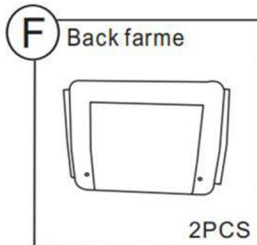
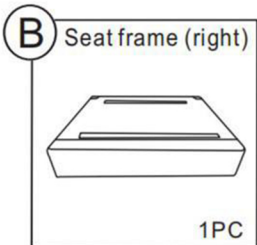
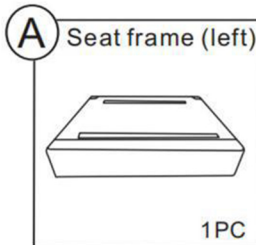

BOX 3

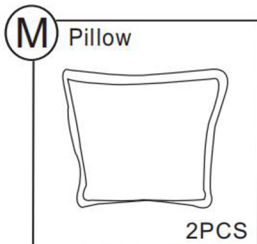
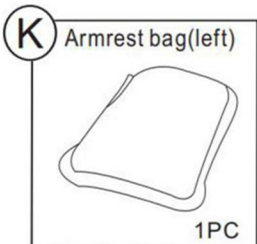
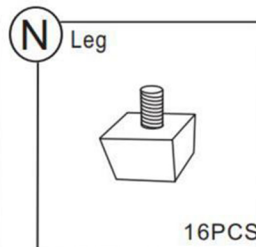
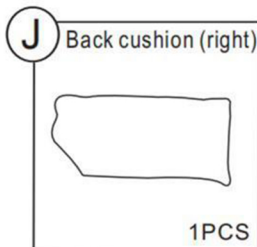
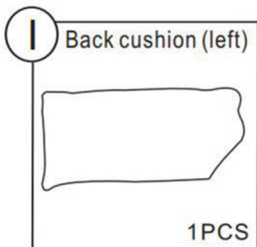
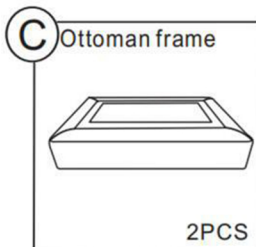



Hardware
+
Manual

DIAGRAM 1 (Assemble the Armrest to the Seat frame)

Connect the Armrest(left)(Part D) to the Seat frame(left)(Part A)

with the Screws M8X35mm (Hardware 1) and the Washers (Hardware 2) by Wrench (Hardware 4).

1		4PCS
2		4PCS
4		1PCS

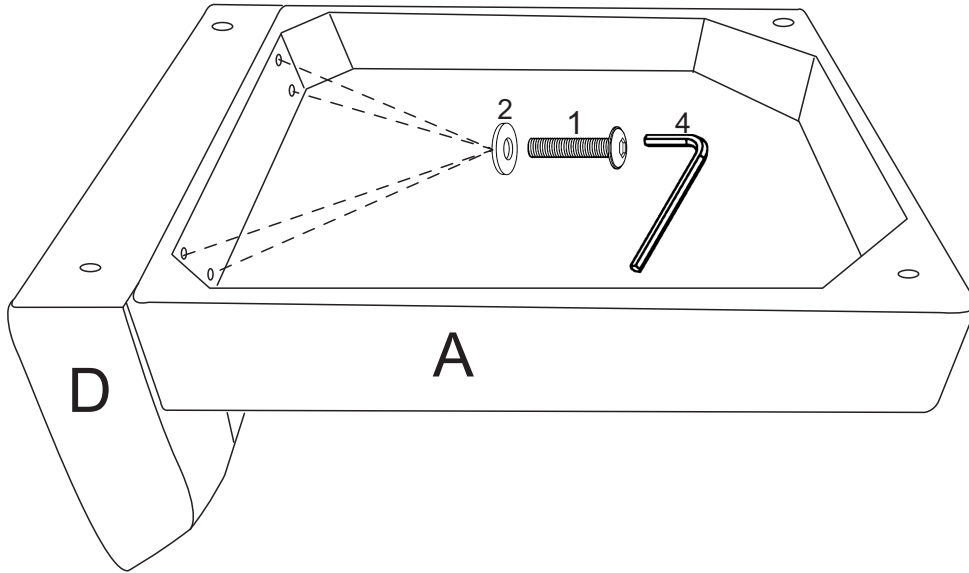





DIAGRAM 2 (Assemble the Armrest to the Seat frame)

Connect the Armrest(right)(Part E) to the Seat frame(right)(Part B)

with the Screws M8X35mm (Hardware 1) and the Washers (Hardware 2) by Wrench (Hardware 4).

1		4PCS
2		4PCS
4		1PCS

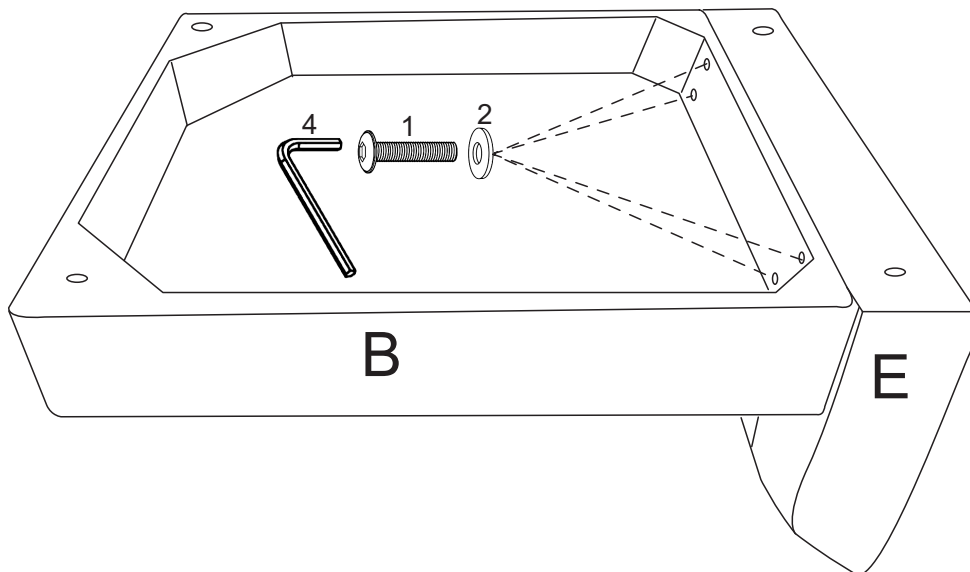



DIAGRAM 3 (Assemble the Legs)

3		16PCS
N		16PCS

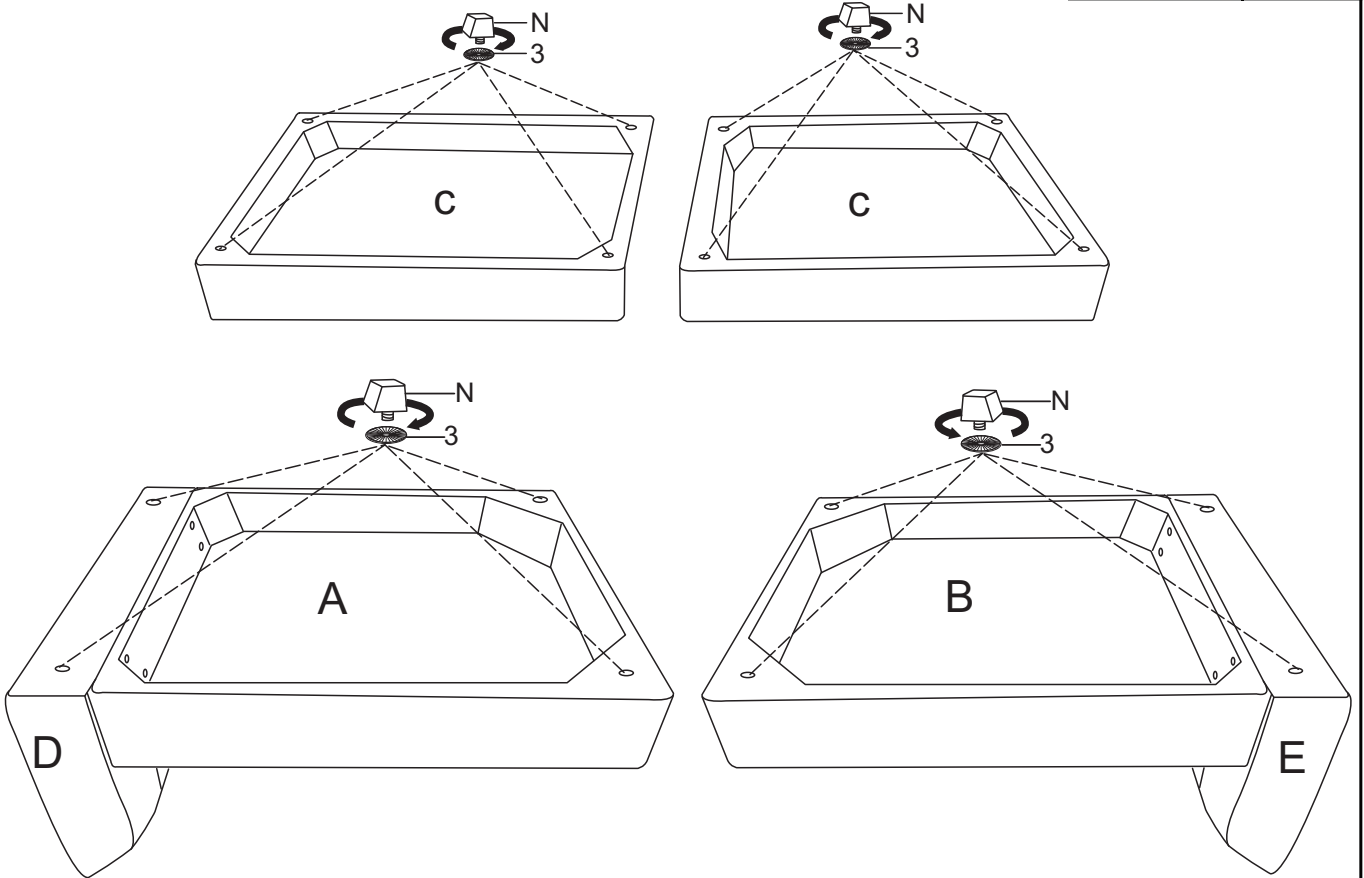





DIAGRAM 4 (Assemble the Back frames)

Connect the Back frames (Part F) by Screws M8x35mm(Hardware1) and Washers (Hardware2) by Wrench(Hardware4) as shown. Then put Velcro pieces together.

1		8PCS
2		8PCS
4		1PCS

Please install the top Screws first, then the bottom Screws.

Make sure all the Screws are in the holes before tightening them.

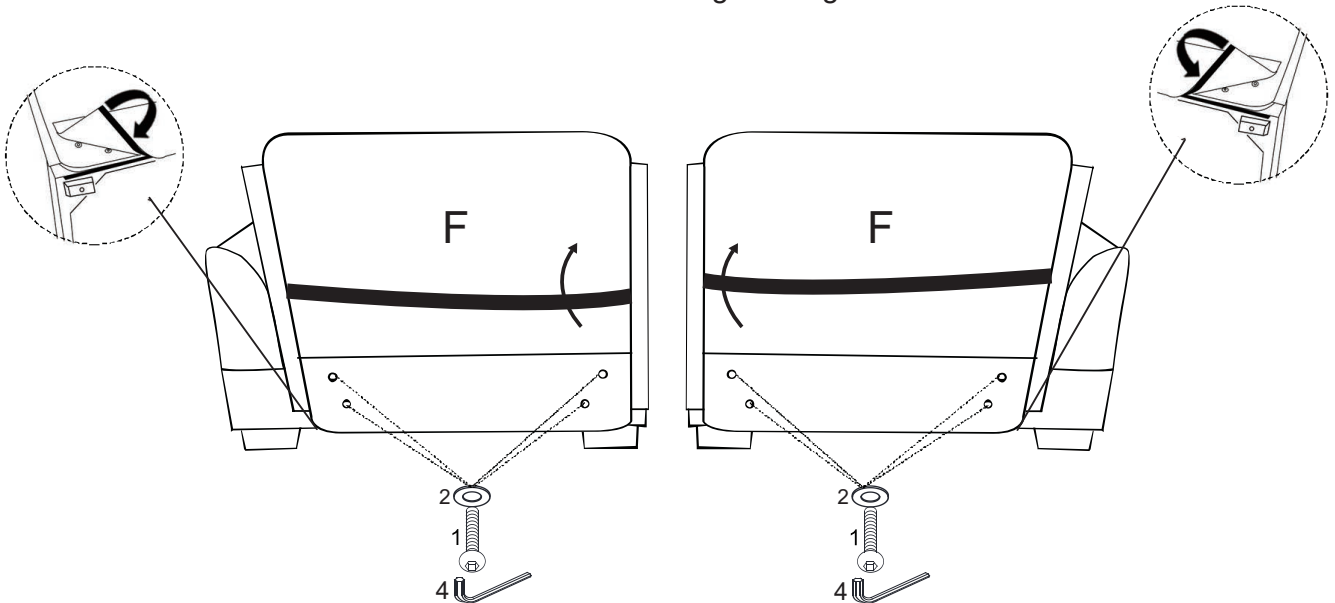

DIAGRAM5 (Removal of compressed bags)

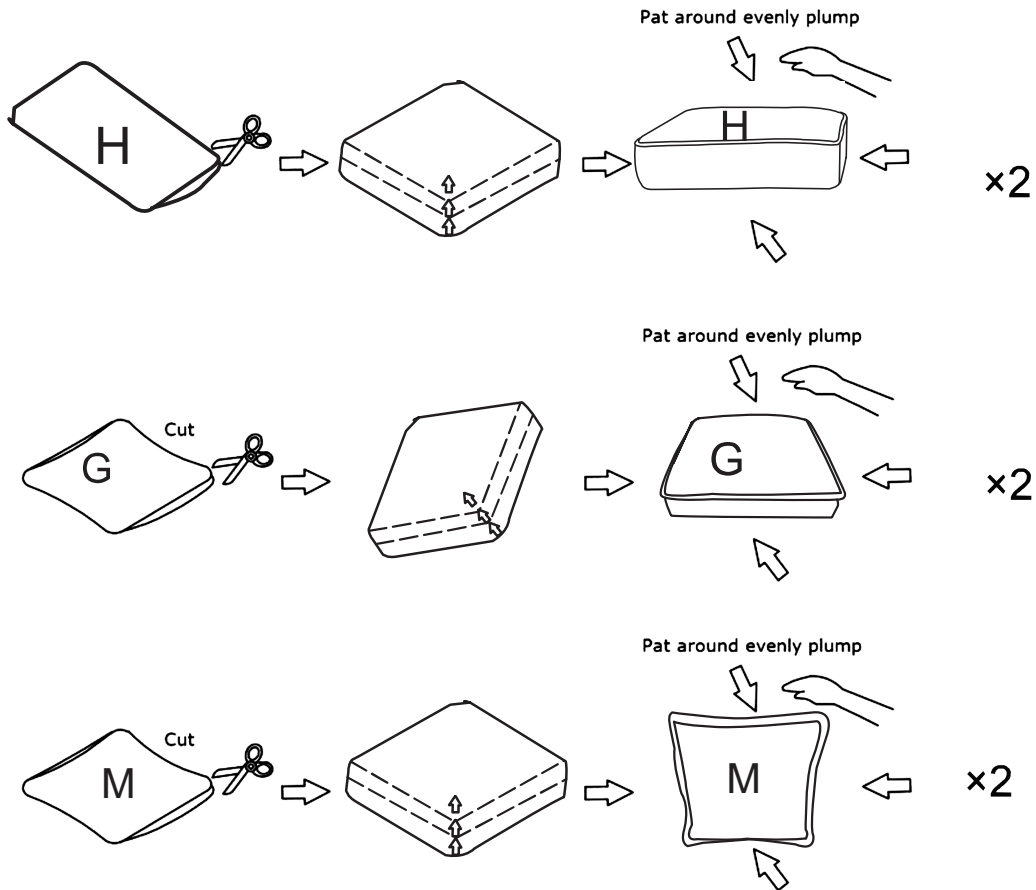
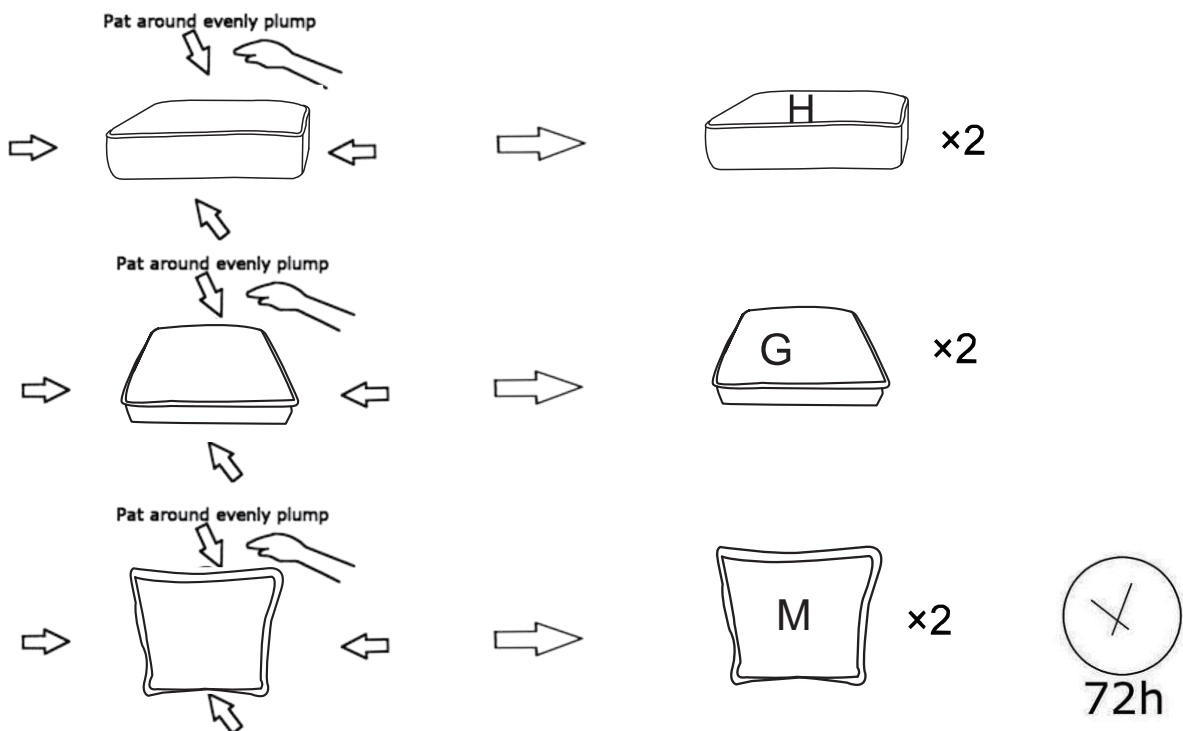

DIAGRAM6 (Waiting for 72H)



TIPS:

1. Please do not open the compressed packages until your sofa frame is completely assembled.
2. Compressed Back cushions and Seat cushions need to be fully fulfilled within 72 hours for your perfect use.
3. Please keep children away from plastic bags or any small pieces of stuff.

DIAGRAM 7 (Connecting the Seat frame)

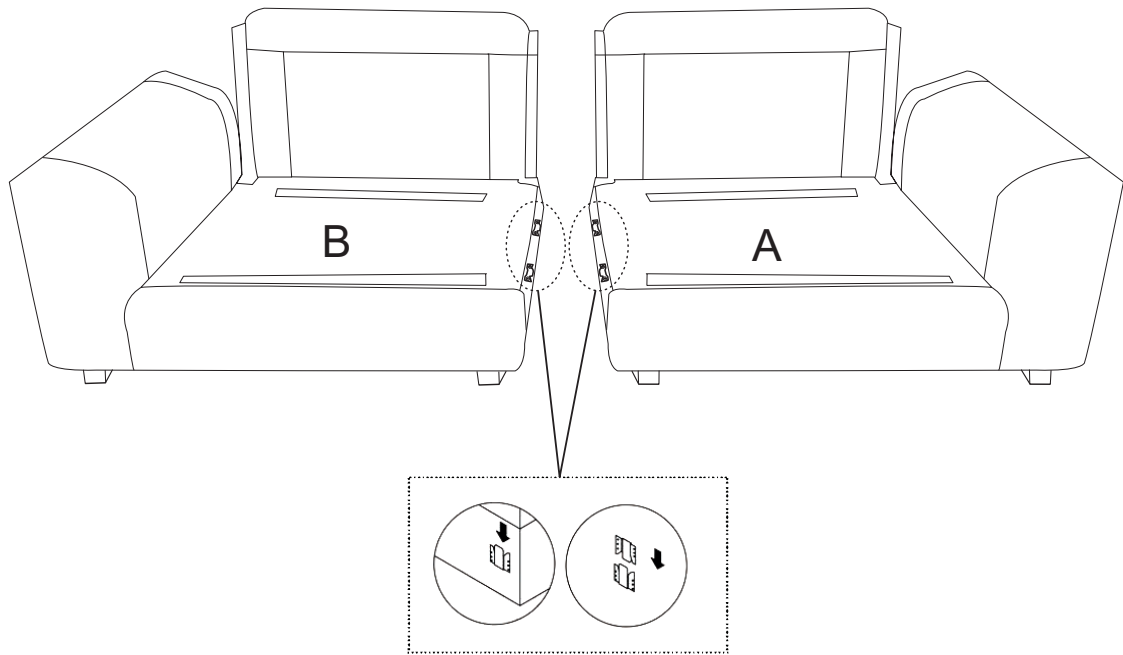

DIAGRAM 8 (Connecting the Armrest bags)

Attach Armrest bag(left)(Part K) and Armrest bag(right)(Part L) to Armrest(left)(Part D) and Armrest (right)(Part E) with zippers then put the velcro pieces together.

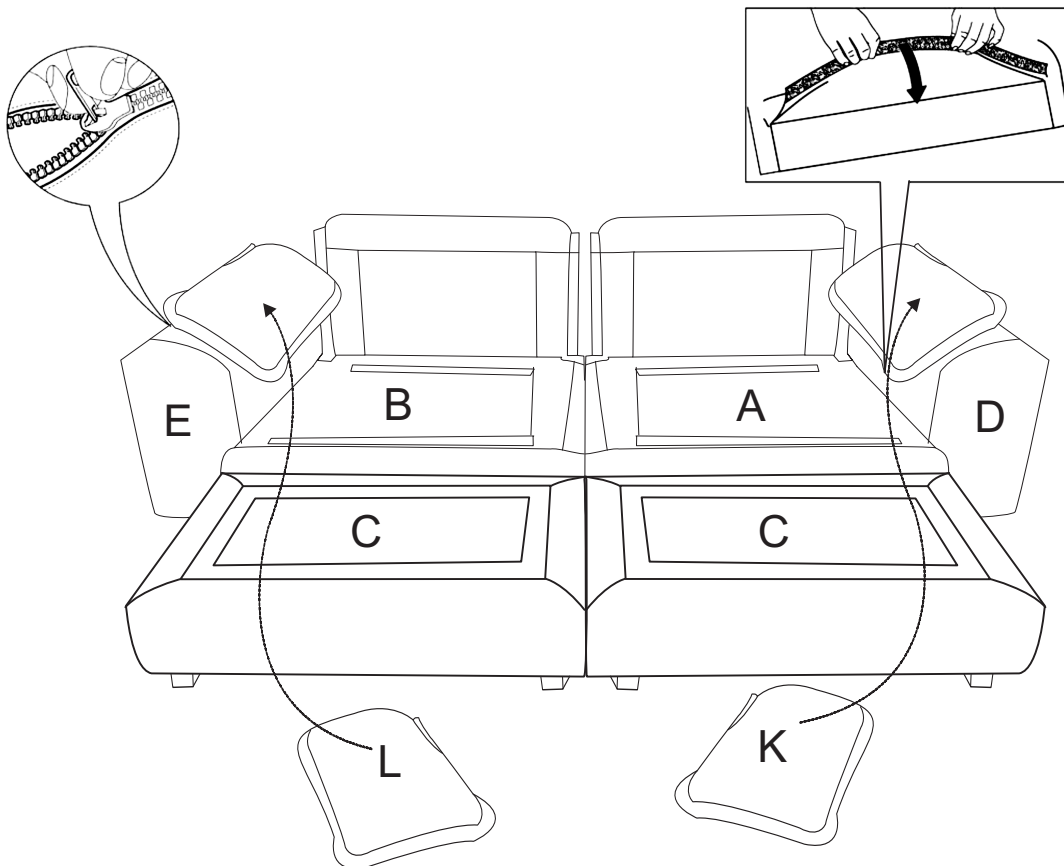
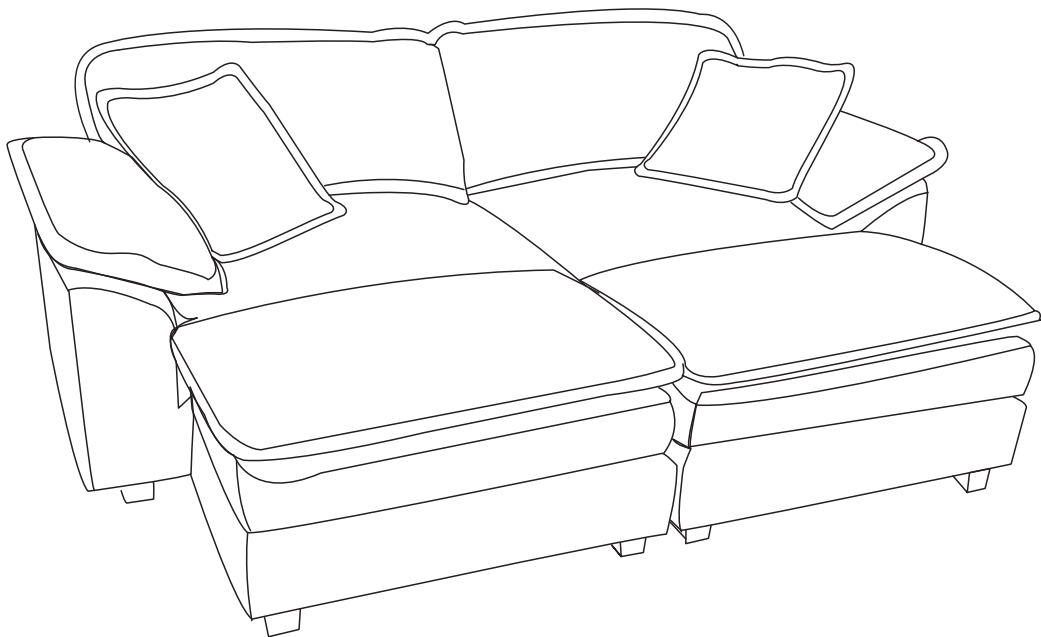
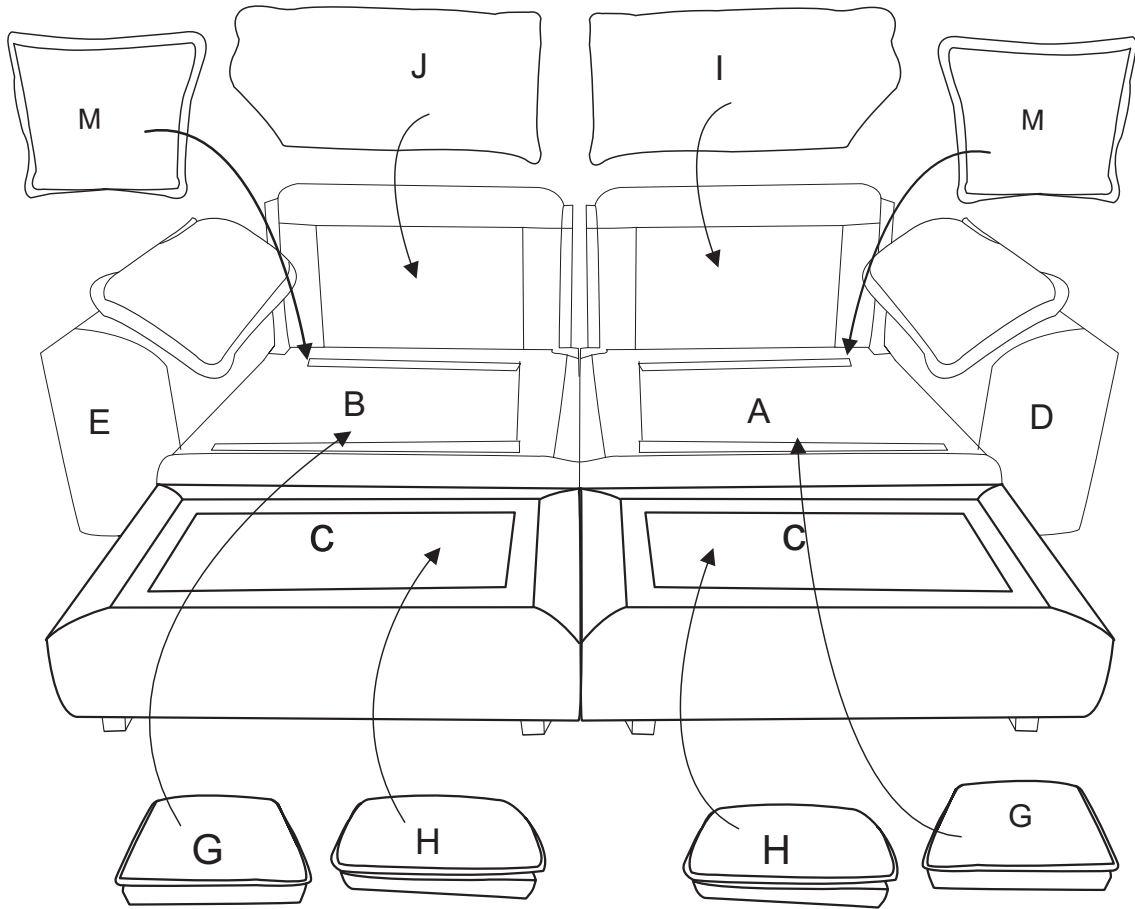

DIAGRAM 9 (Place cushions on the sofa)

Place the Seat cushions, Ottoman cushions, Back cushions, Pillows on the sofa



COMPLETE