

Dear Customer

Thank you for purchasing our corduroy sofa. Please check the product for damage and missing accessories after receiving the package. If you encounter any problems, please send us an email and you will get a professional solution within 24 hours, we value your suggestions and feedback very much.

The armrests, backrests, and pillows are placed **inside the base**. Please turn the base over and unzip it to find these parts. Please note that the upholstery is vacuum compressed and will expand and return to its optimal state within 24-48 hours. It will take 10-20 minutes to install this sofa by yourself, and you will also need an extra screwdriver.

Let's get started!

Assembly Instructions

Please check the package quantity first.







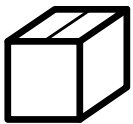

2-seater sofa contains 1 cartons A.

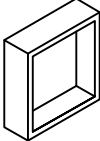
3-seater sofa contains 1 cartons A and 1 carton B.

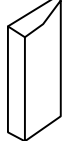
4-seater sofa contains 1 cartons A and 2 cartons B.







Carton A

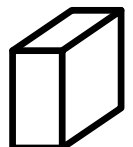

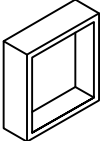
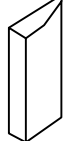
								
Base 2PCS	Armrest 2PCS	Backrest 2PCS	Cushion 2PCS	Pillow 2PCS	M6 Screw 8PCS	M6 Gasket 8PCS	3CM Leg 8PCS	M5 Screws 8PCS

Carton B



							
Base 1PC	Backrest 1PC	Cushion 1PC	Pillow 1PC	M6 Screw 2PCS	M6 Gasket 2PCS	3cm Leg 4PCS	M5 Screws 4PCS

Step 1: Flip the sofa base over, unzip it and remove all the parts.

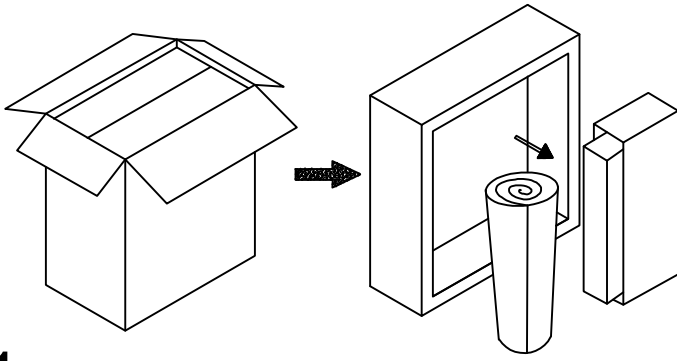

1

Step 2: Install the legs using screws and a screwdriver.

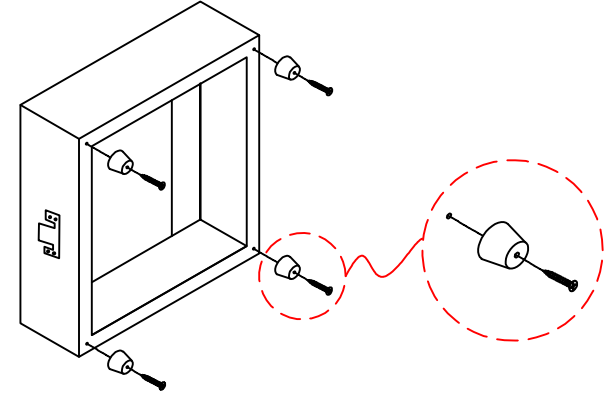

2

Step 3: Use screws and screwdriver to install the armrests and backrest. (the middle position does not require armrests)

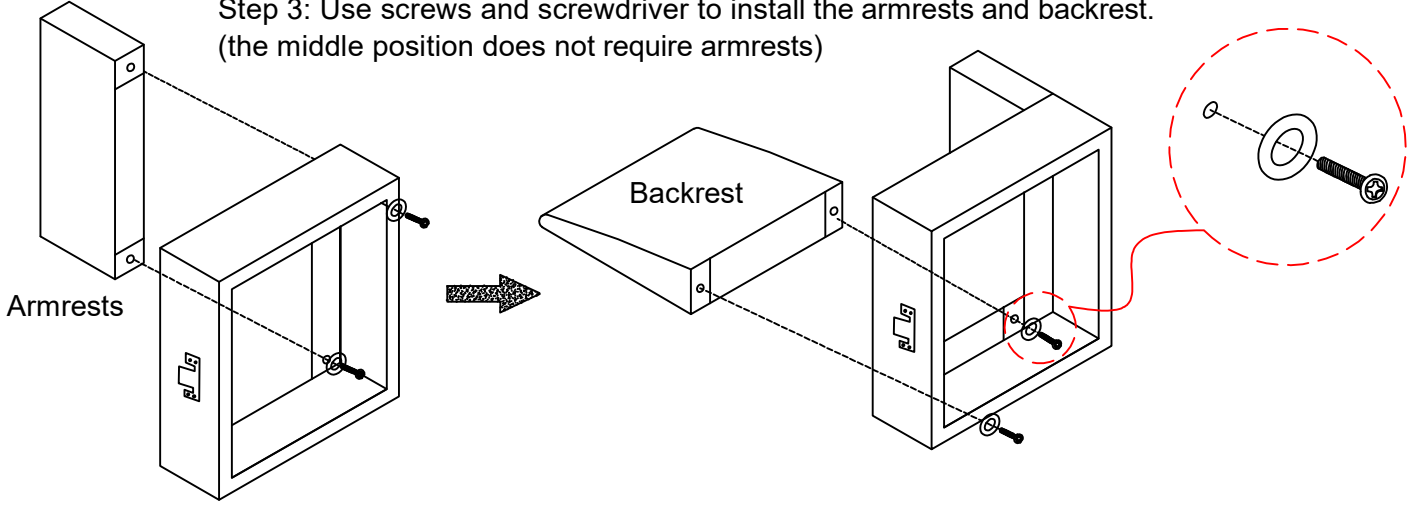

3

Step 5: Unpack the cushions and soft bags to unzip them and place them on the seat.

Note: Due to vacuum packaging and transportation of the soft bag, the sponge filled inside will take 24-48 hours to return to its softest state.

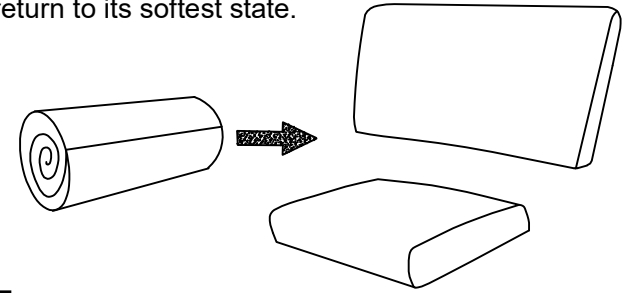

5

Step 4: Fasten the sofa together using the connectors between the seats.

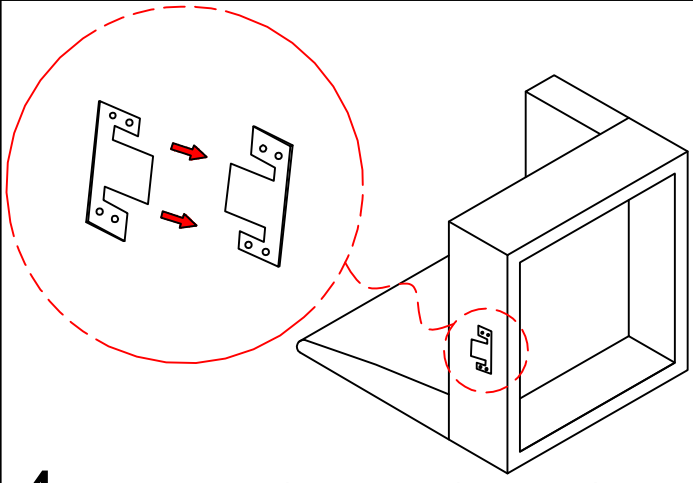

4

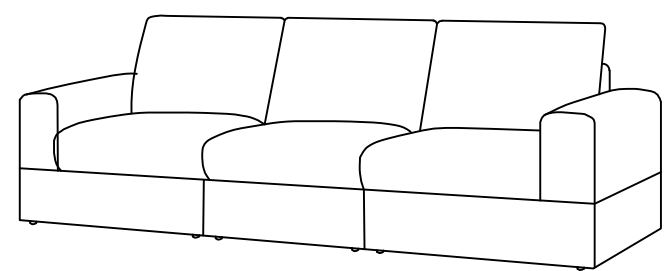
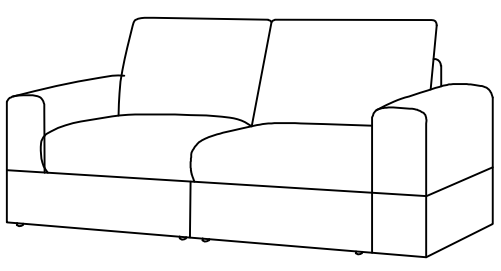

6

FINISH!