

Assembly Instructions

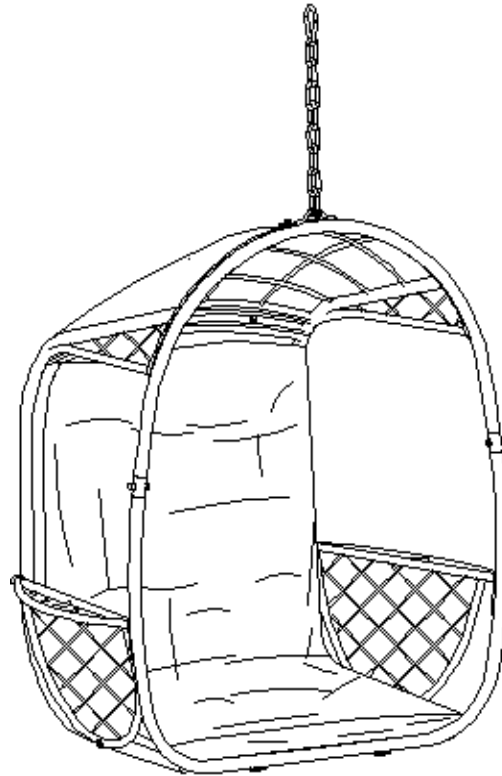

Caution : You should read this before you proceed

BASKET CHAIR



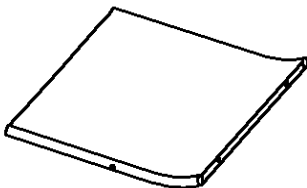
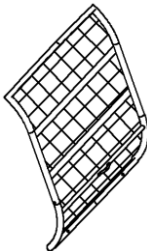

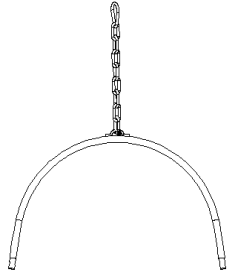
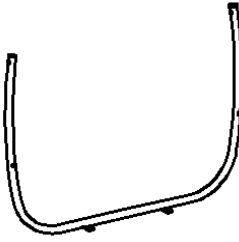
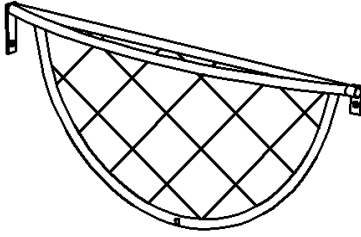
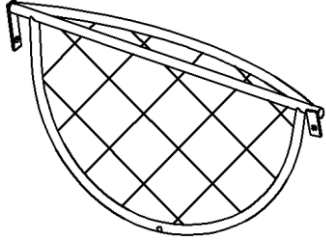
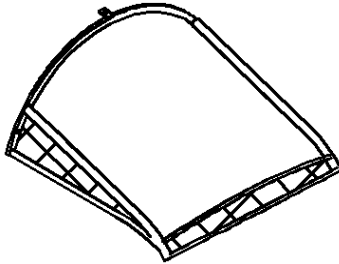





Parts List

Label	Picture	Description	QTY
A		Basket Seat	1
B		Basket Back	1

C		Basket Frame - Top	1
D		Basket Frame - Bottom	1
E		Right Armrest	1
F		Left Armrest	1
G		Basket Top	1
H		Cushion	1

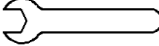
Hardware

Label	Picture	Description	QTY
①		Plastic Bolt Cap	19
②		Plastic Nut Cap	3
③		Bolt M6*20mm	8
④		Bolt M6*35mm	10
⑤		Bolt M6*40mm	3
⑥		Nut	3
⑦		Washer Ring	21
⑧		Wrench	1
⑨		Allen Key	1

Assembly Preparation

Before Beginning Assembly:

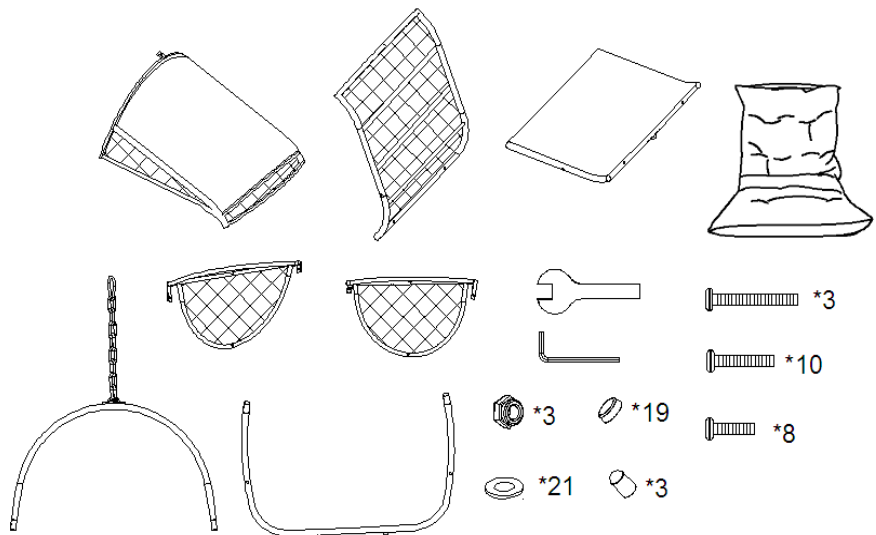

- Read instructions, cover to cover-



- Have 2 adults on hand for assembly-



- Do not assemble on flooring or carpet-



- Assemble on a clean non-marring surface (packing foam)-



- Save all packaging until finished-

Assembly Steps

Overview

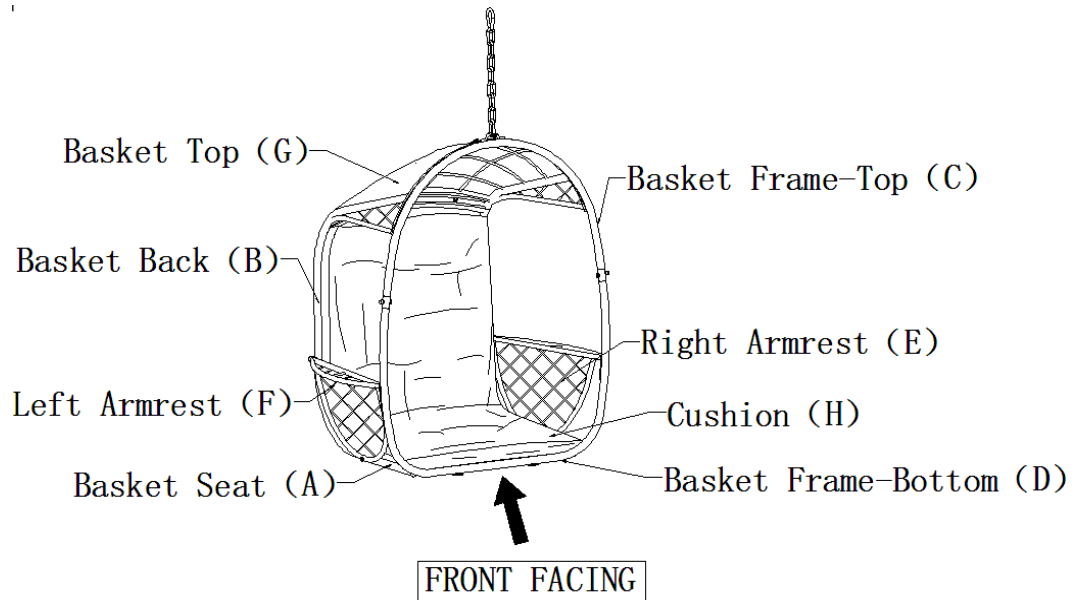

This Basket Chair has multiple parts and may require up to some 30 minutes to assemble. To give you an overview of the Basket Chair parts, the above picture is provided to help you put the various parts into perspective. Please read through the instructions below to familiarise yourself with the parts and steps before assembly.

Step 1

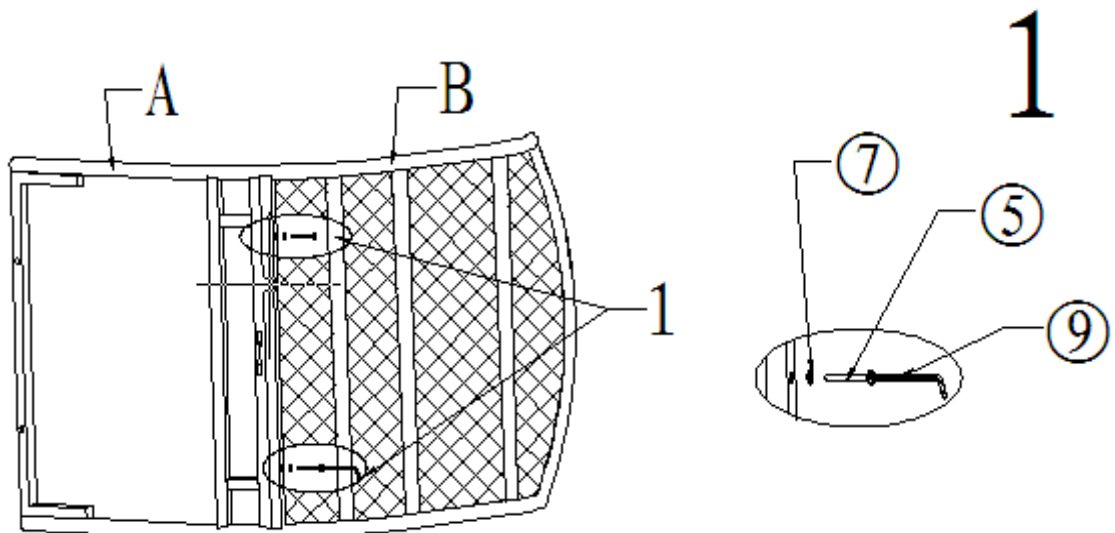

Open the carton and place all the parts onto a clean, soft surface.

Unpack all hardware packages.

Put the Basket Seat(A) against the Basket Back(B) and line up the two mounting positions of both.

Attach the Basket Seat(A) to the Basket Back(B) with the Allen Key(9), using Flat Washers (7) and Bolts (5), as shown in the picture above.

Do not fully tighten the Bolts at this stage.

Caution:Two or three adults are required for assembly at this step.

Step 2

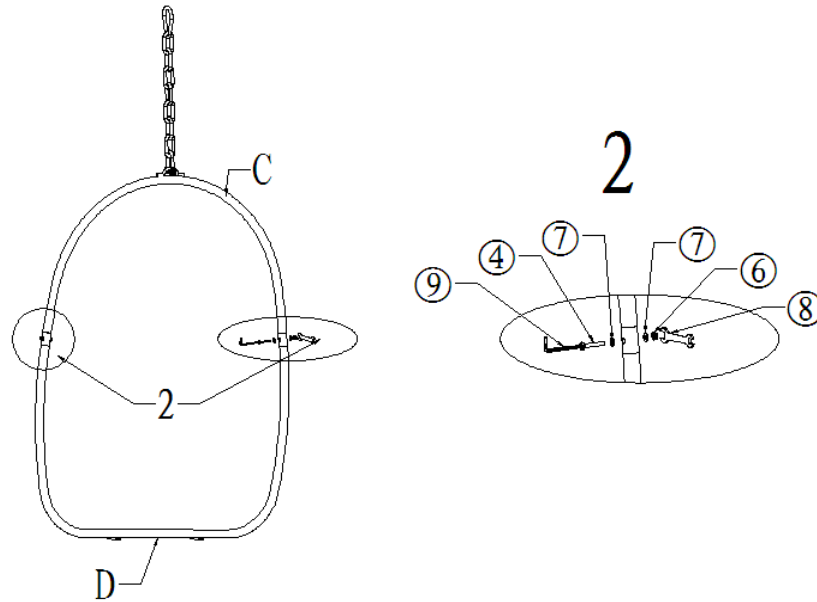

Attach the Basket Frame - Top(C) to the Basket Frame - Bottom (D) with the Allen Key(⑨) and Wrench (⑧), using Bolts (④), Washers(⑦) and Nuts (⑥) as shown in picture above.

Do not fully tighten the bolts.

Caution:Two or three adults are required for assembly at this step.

Step 3

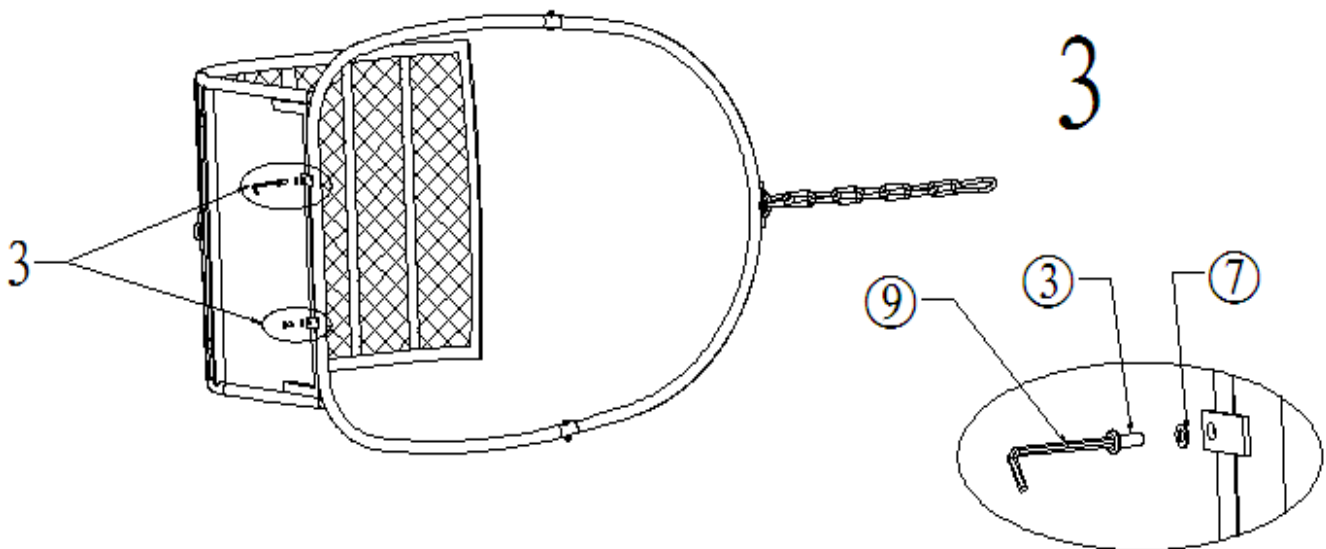

Attach the Basket Frame - Top(C) and the Basket Frame - Bottom (D) to the Basket Seat(A) with the Allen Key(⑨), using Bolts (③) and Washers(⑦) as shown in the picture above.

Do not fully tighten the bolts.

Caution:Two or three adults are required for assembly at this step.

Step 4

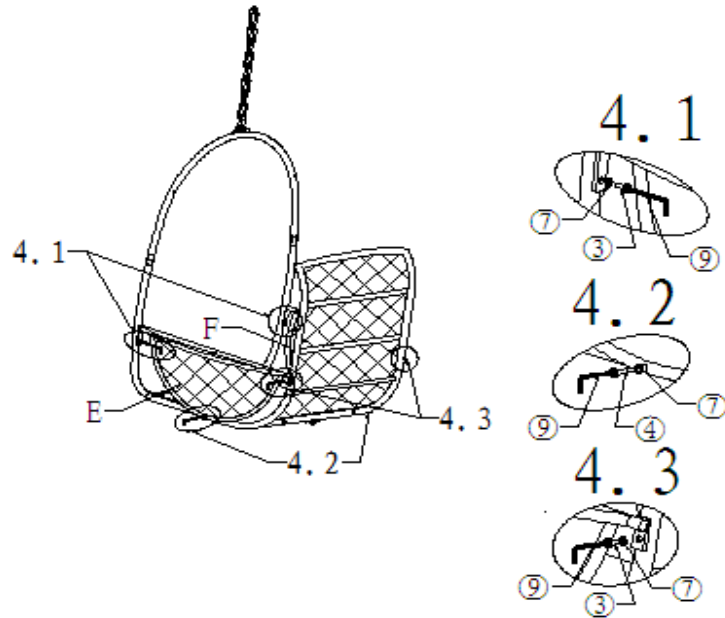

Stand the Basket Chair upright.

Attach the Right Armrest(E) to the Basket Seat(A), Basket Back(B) and the Basket Frame - Bottom (D) with the Allen Key(⑨), using Bolts(④), Bolts(③) and Washers(⑦), as shown in the picture above.

Repeat the same process with the Left Armrest(F).

Do not fully tighten the bolts.

Caution:Two or three adults are required for assembly at this step.

Step 5

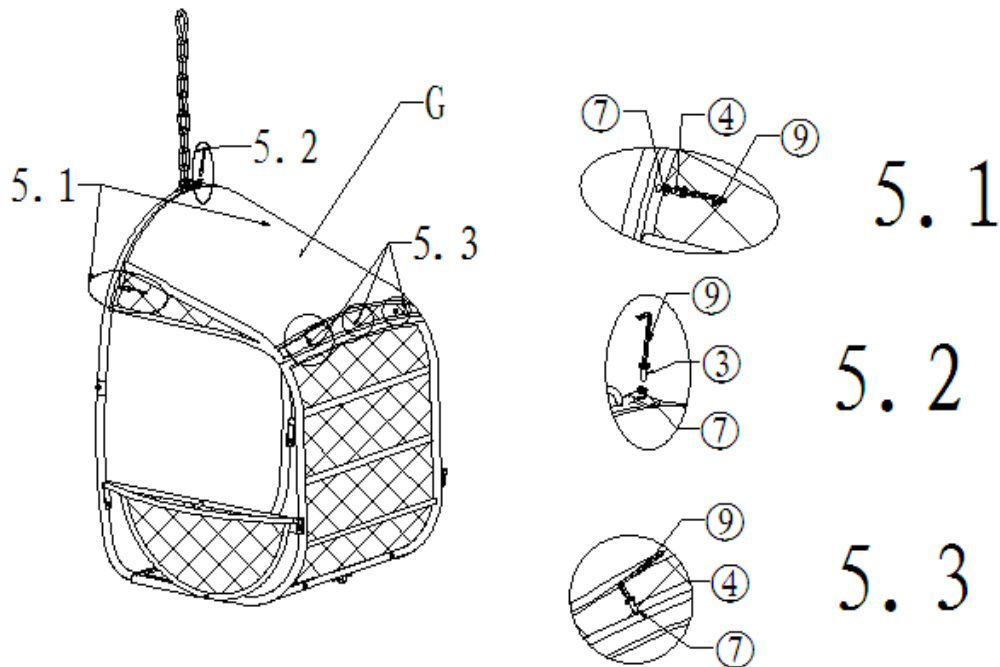

Attach the Basket Top(G) to the Basket Back(B) and the Basket Frame - Top (C) with the Allen Key(⑨), using Bolts(④), Bolts(③) and Washers(⑦) as shown in the picture above.

Do not fully tighten the bolts.

Caution:Two or three adults are required for assembly at this step.

Step 6

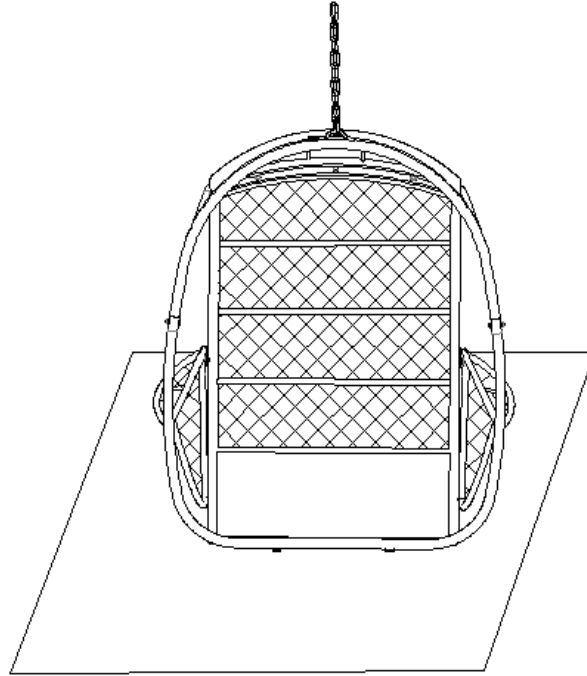

Check for stability and then tighten all Bolts at all joints.

Note: DO NOT fully tighten a Bolt in one go and then move on to the next.

Rather in a sequential manner, gradually tighten each Bolt until all Bolts are evenly secured. This methodology will ensure maximum evenness once all Bolts are fully tightened.

Step 7

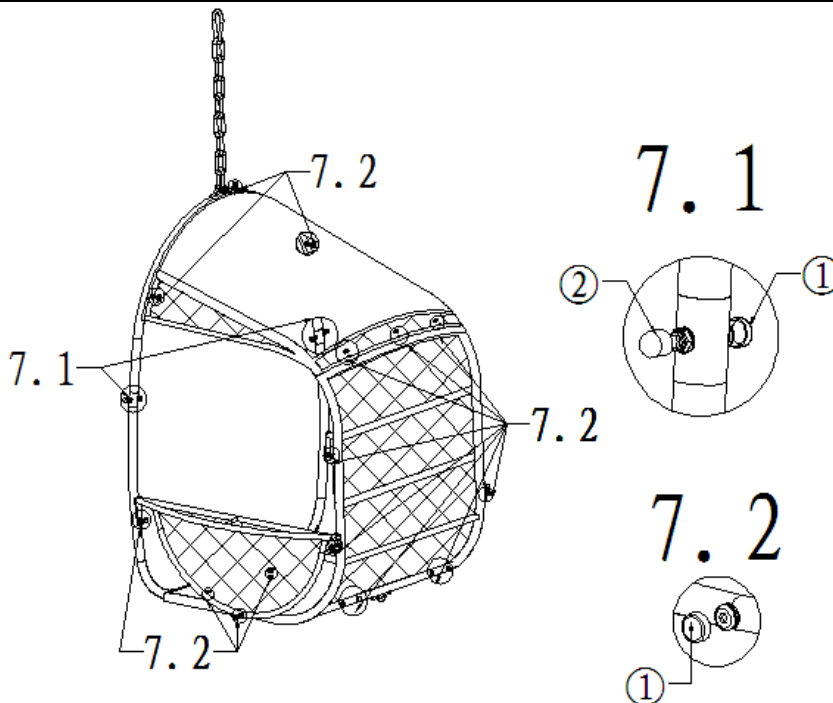





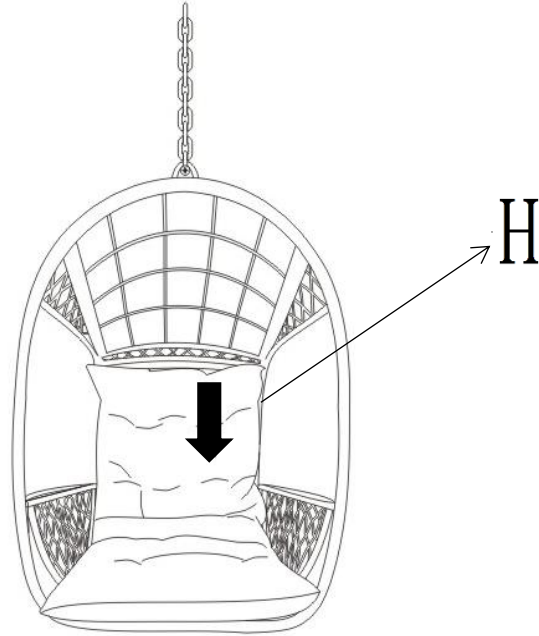













Cover all the Bolts and nuts with the Bolt Caps(①) and the Nut Caps(②) as shown in pictures 7.1 and 7.2.

Step 8



Place the Cushion(H) in the Basket.
Your Basket Chair is ready for use.

Care & Maintenance

-   • Do not put hot items directly on furniture surface
 -   • Do not clean furniture with harsh cleansers or polish.
 -  • To obtain the longest lifespan of your outdoor products, minimizing exposure to direct sunlight is recommended.
 -   • Children should not climb or jump on the furniture.
 -   • Do not write on furniture without a padded barrier to protect the surface.
 -  • To obtain the longest lifespan of your outdoor products, avoid extended and lengthy exposure to rain, snow, and direct sunshine. Whenever possible cover the product and /or place under patio or awnings.
 -   • Not for commercial use. For residential use only .
 -   • Stains may be removed with mild soap solution and damp cloth.
 -   • Keep away from sources of ignition.
-
-   • Dust and pick-up spills using a clean, non-colored, lint-free cloth .