

ASSEMBLY INSTRUCTION

ITEM NO.:

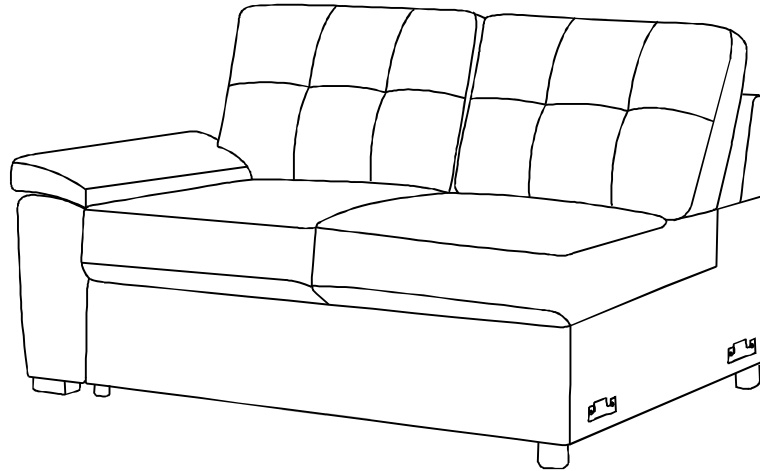

PARTS LIST

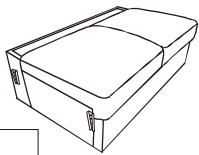

A

x1

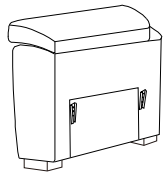

B

x1

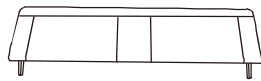

C

x1

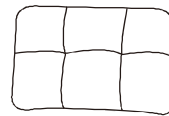

D

x1

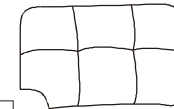

E

x1

HARDWARE LIST



1

x4

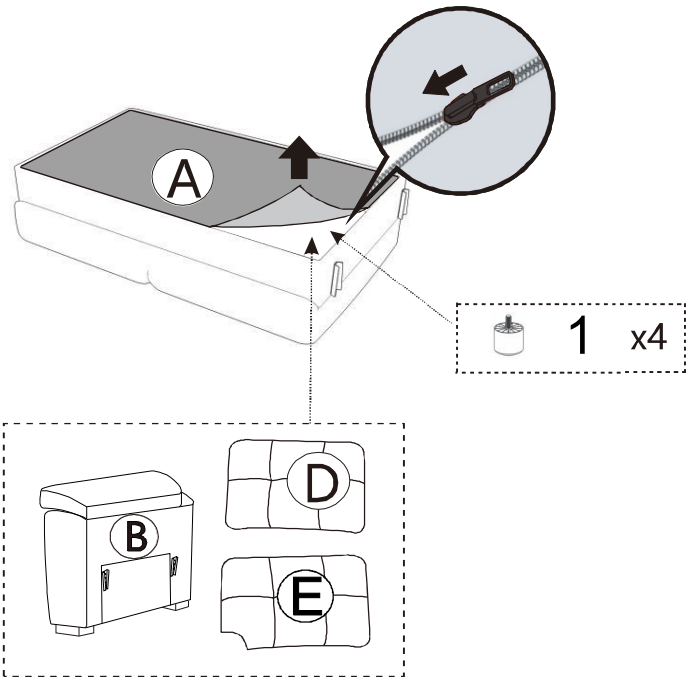

Step1

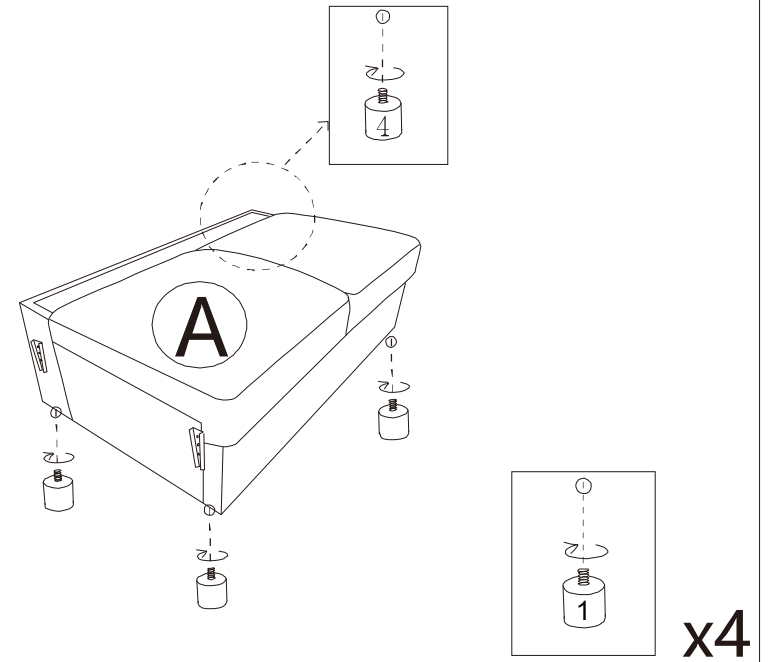

Step2

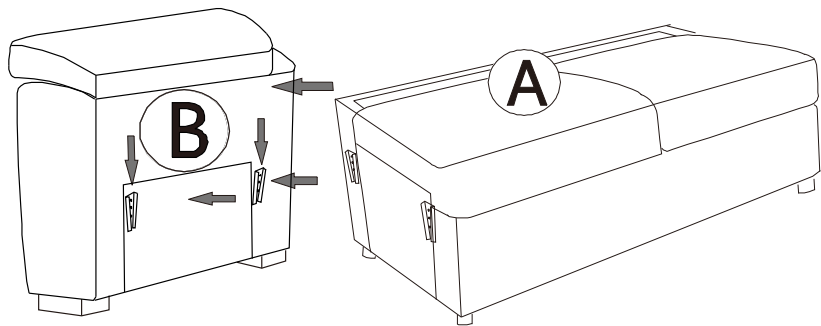

Step3

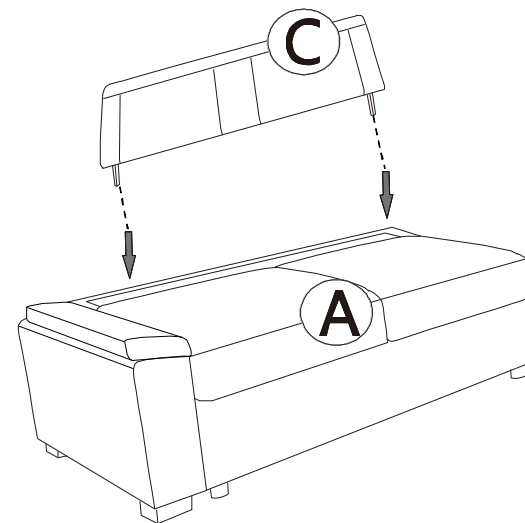

Step4

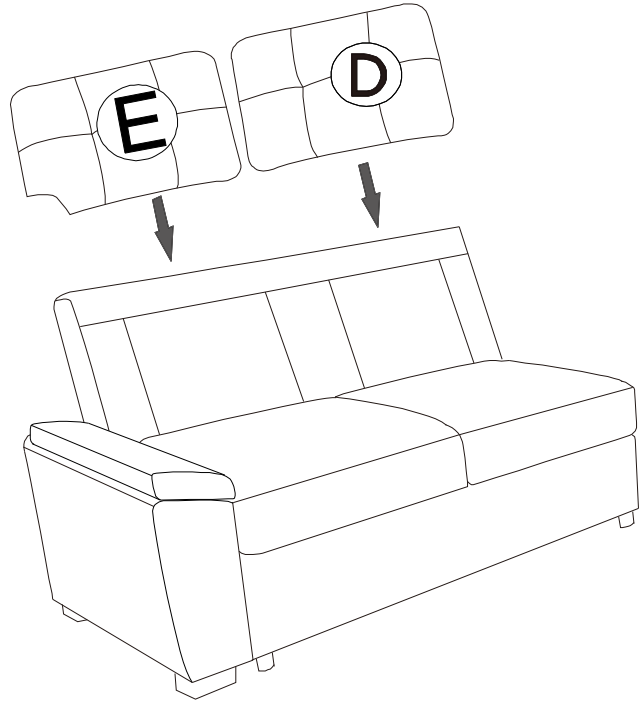

Step5

