

INSTRUCTION MANUAL

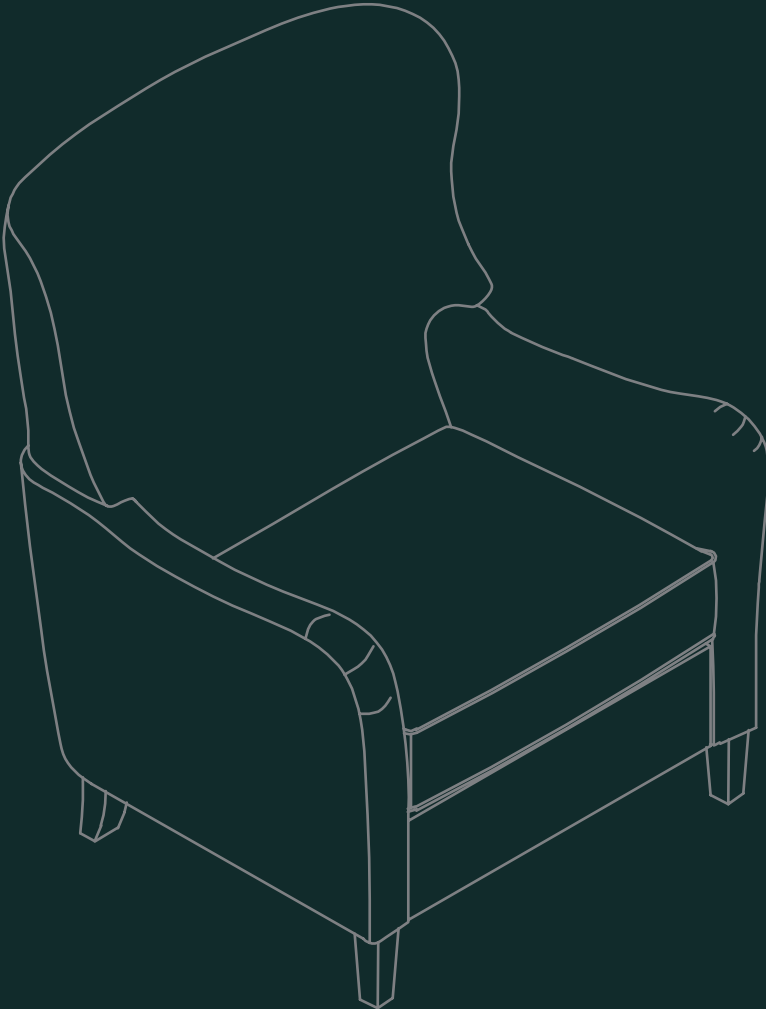

WARNING

 **Please read the instructions carefully and follow the assembly steps.**

To ensure proper assembly, please follow all steps and use all parts provided. Not following this warning may result in serious injury to you or others.

To prevent misalignments, keep the screws loose and do not tighten them until they are all in their correct positions.

Avoid overtightening or forcing the screws, as this could cause them to break, strip, or damage the threads of the holes.

Using the wrong size of screws for a particular part could cause damage to the screw or the part.

Please lubricate all moving parts regularly and tighten all bolts and screws every 6 months, or as needed.

SAFETY INFORMATION

WEIGHT CAPACITY FOR SEATING: 300LBS



Sit in the center of the chair with your back against the backrest



Do not sit at the front edge of the chair



Do not stand on the chair



Do not use the chair with more than one person



Do not push the chair around when a person is sitting in it



Do not push down on the backrest when a person is reclined



Do not place all your weight on the backrest only

ASSEMBLY PARTS AND TOOL

BEFORE YOU GET STARTED, A FEW POINTERS:



Having a friend to help makes assembly extra-easy



Please use the included wrench instead of an ELECTRIC HAND DRILL in case of damage to the product.

A



Backrest * 1

B

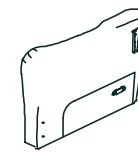

Right Armrest* 1

C



Left Armrest * 1

D

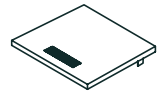

Seat Pad*1

E

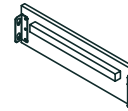

Front Stretcher * 1

F



Seat Cushion * 1

G



Front Leg * 2

H



Back Leg*2

1



Bolt * 4

2



Spring Washer * 4

3



Flat Washer * 4

4



Plastic Washer * 4

5



Wrench * 1

PLEASE MAKE SURE ALL THE PARTS ARE INCLUDED.

MISSING PARTS? support@colamyhome.com

ASSEMBLY INSTRUCTIONS

Tips: Please do not 100% tighten all the bolts until the chair is fully assembled, just 50% is OK, make it has space to adjust the chair.

Step 1

Put Plastic Washer (4) on each leg, then attach Two Front Legs G and Two Back Legs H onto the bottom of Right Armrest B and Left Armrest C.

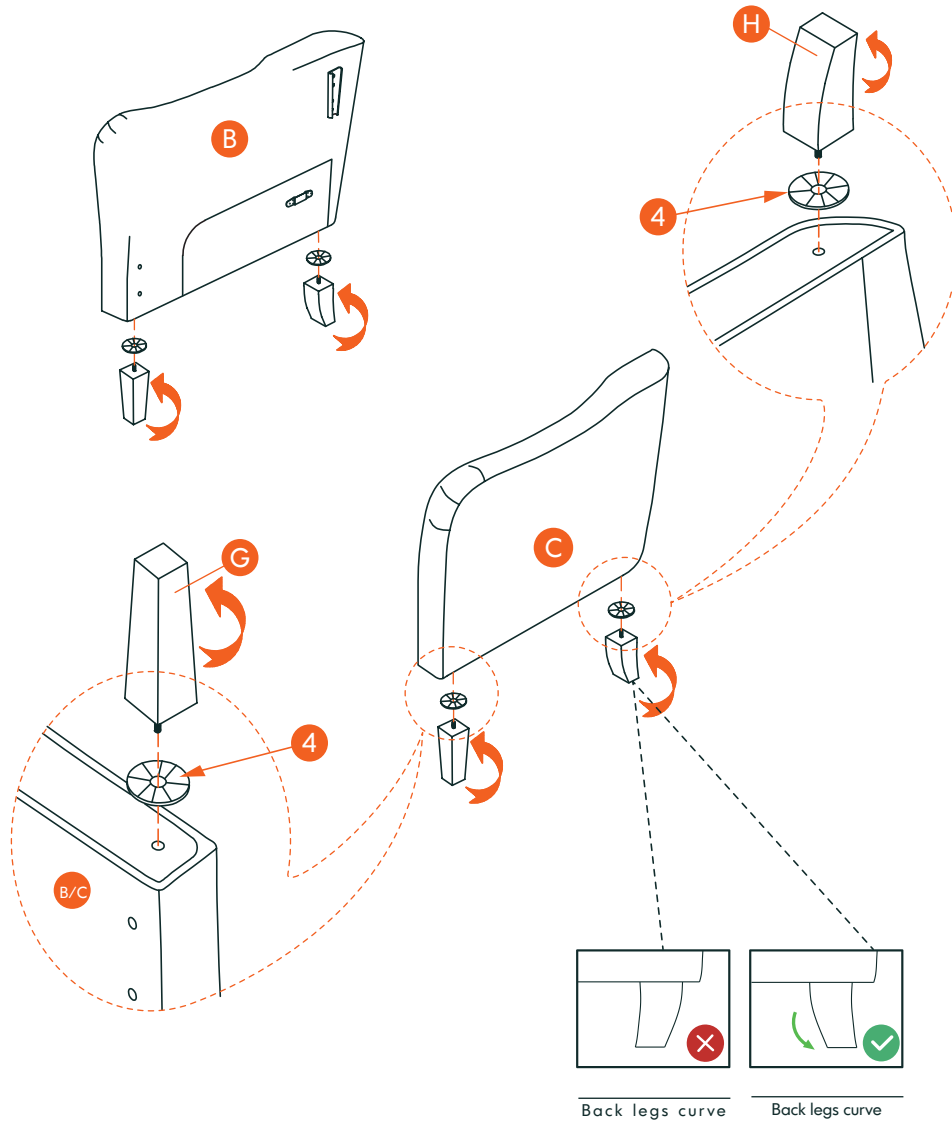

ASSEMBLY INSTRUCTIONS

Step 2

Connect Two arms with Front Stretcher E, using Four Bolts (1), including Spring Washers (2) and Flat Washers (3), tighten by Wrench (5).

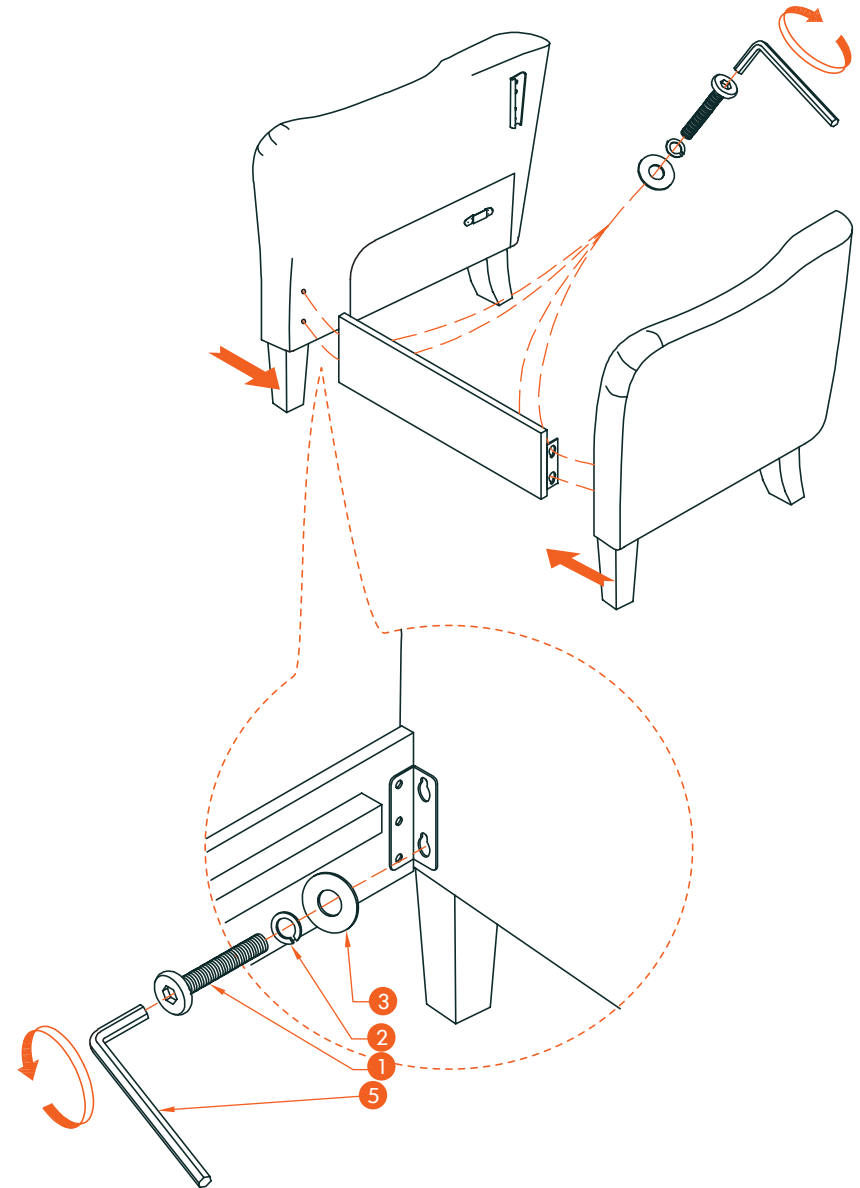

ASSEMBLY INSTRUCTIONS

Step 3

Put Seat Pad D onto the finished chair frame, align the slots on both side of two arms and press down the seat pad until the connection is secure.

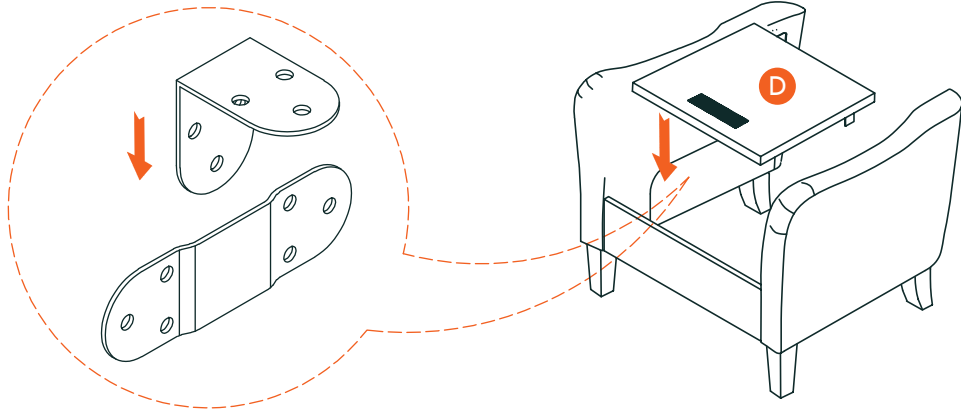

Step 4

Attach Backrest A to the chair frame, align the slots and press down the backrest until the connection is secure.

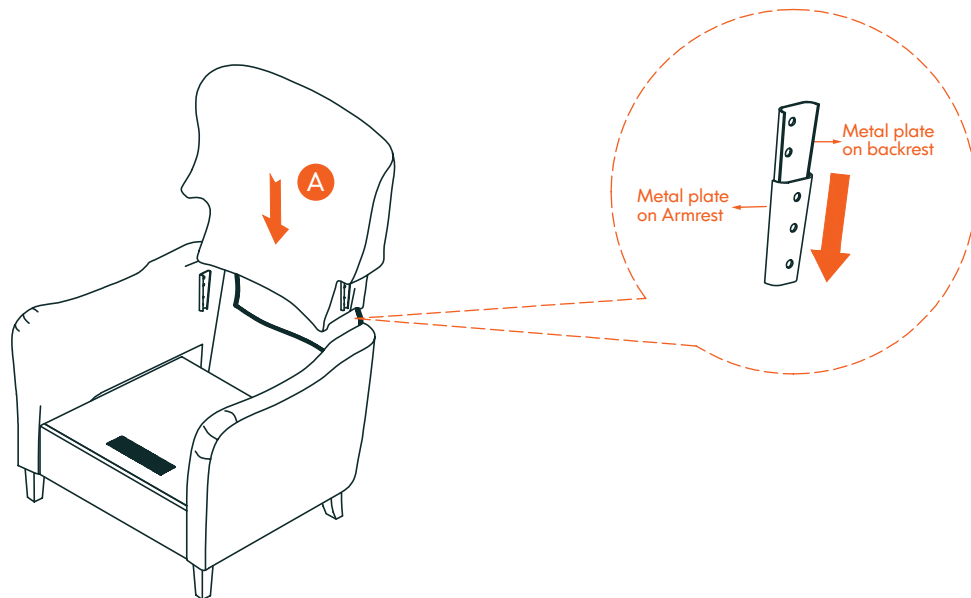

ASSEMBLY INSTRUCTIONS

Step 5

Put Seat Cushion F onto the correct position of the chair. Now your chair is successfully assembled.

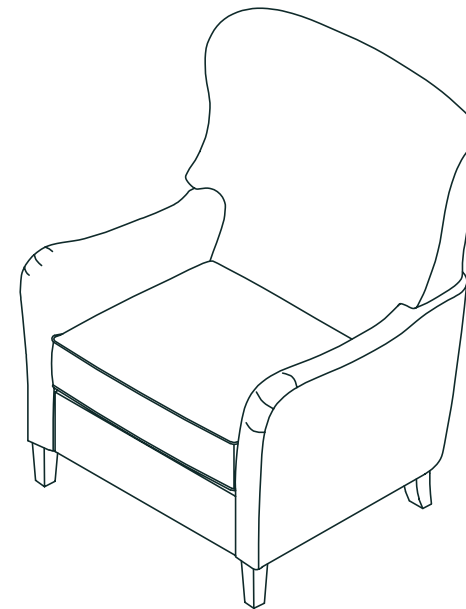
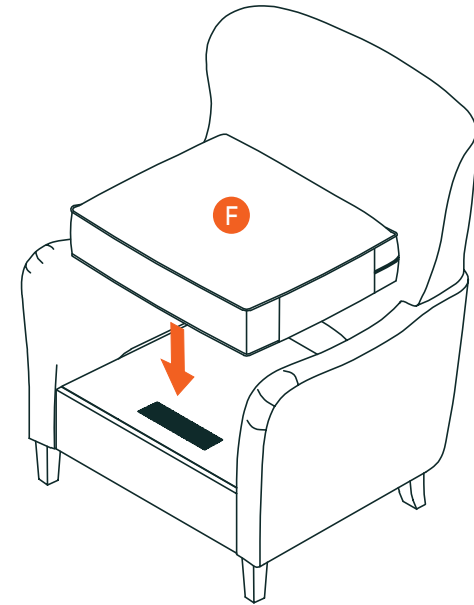

LIMITED WARRANTY

promises to repair or replace any COLAMY chair that is found to be defective in material or workmanship within one year from the date of original purchase so long as you, the original purchaser, still owns it. This is your sole and exclusive remedy. This warranty is subject to the provisions below.

EXCLUSIONS

This warranty does not apply and no other warranty applies to:

- Normal wear and tear, which are to be expected over the course of ownership.
- Misuse, abuse, or excessive use of the product.
- Modifications or attachments to the product that are not approved by COLAMY.
- Products that were not installed, used, or maintained in accordance with product instructions and warnings.
- Products used for rental purposes or unauthorized retail activities.

Seating Usage: Normal use for seating is identified as the equivalent of a single shift, forty- (40) hour workweek. To the extent that a seating product is used in a manner exceeding this, the applicable warranty period will be reduced in a pro-rata manner.

RETURN POLICY

We adopt a 30-day return policy which means that all products purchased on this website may be returned to us within the timeframe. You need to contact us within 30 days after the product(s) came into your possession and the product(s) must be returned to us without any undue delays.

Returned products must be returned in the same condition as they were sent and they must be sent in their original packaging.

If the product is not faulty, (i.e. if you changed your mind or if you are unhappy with the product for some other reason), the cost of shipping will fall on you. And it is your responsibility that the package arrives safely to us so we recommend that you use a courier service where it is possible to track the shipment.

LIMITED WARRANTY

If the product is faulty when you receive it, please contact us and we will help you out.

We reserve the right to give a partial refund in cases when the product(s) is not in an unused condition, is damaged or has missing parts, not due to our error.

HOW RETURNS WORK

To request a return, please fill out the contact form on our website and attach a copy of your invoice as proof of purchase and the reason for your return in the message.

Then we will provide the return address for the product as soon as possible.

Once the returned product has been received by us and inspections have been completed, a specific disposition will be provided to you.

In addition, if the return is approved, the refund amount will be automatically credited to your original payment method.