







Duo Panel

Twin • Full
Queen • King

Examine all packaging material for small parts that may have come loose during shipment. Periodic checks are recommended to insure that all components are in proper position, tight and free from damage. Keep this assembly instruction for future reference. Adult assembly is required.

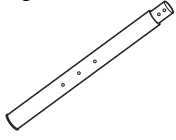
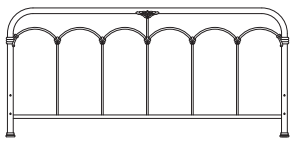
CODE	QTY	HARDWARE
1	4	1/4" x 2" Sunk Bolts 
2	4	1/4" x 1" Allen Bolts 
3	4	1/4" Flat Washers 
4	4	1/4" Hex Nuts 
5	1	Allen Wrench 

CODE	QTY	COMPONENTS	CODE	QTY	COMPONENTS
A	2	Leg Extensions 	B	1	Duo Panel 
C	2	Foot Glides 			

WARNING

- Do not let any sharp objects touch or rub the surface of the product.
- When assembling, do not let children play around the working area.
- Please confirm all parts are correct before starting the assembly process.
- Do not tighten all bolts and screws completely until the entire unit has been assembled and set up.
- Be careful if using power tools as they can over tighten screws and strip threads.

STEP 1 - Figure 1

For purchase of Headboard only

Insert 2 Foot Glides (C) into bottom of Leg Extensions (A) into bottom of Duo Panel (B).

STEP 2 - Figure 2

For purchase of Headboard only

Attach Bed Frame (*Not Included) to each Leg Extension (A) using 2 Long Allen Bolts (1), 2 Flat Washers (3) & 2 Hex Nuts (4) per side. Tighten all nuts and bolts. The headboard assembly is now complete.

STEP 3 - Figure 3

For purchase of Footboard only

Insert 2 Foot Glides (C) into bottom of Duo Panel (B) using 2 Short Allen Bolts (2), & 2 Flat Washers (3) per side. Tighten all bolts using Allen Wrench (5) provided. The footboard assembly is now complete. You may discard both Leg Extensions (A) as they are not needed for the footboard. Please keep instruction sheet for future assembly.

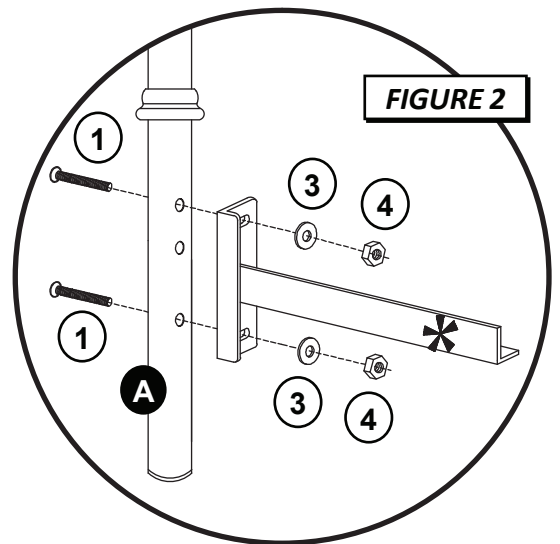
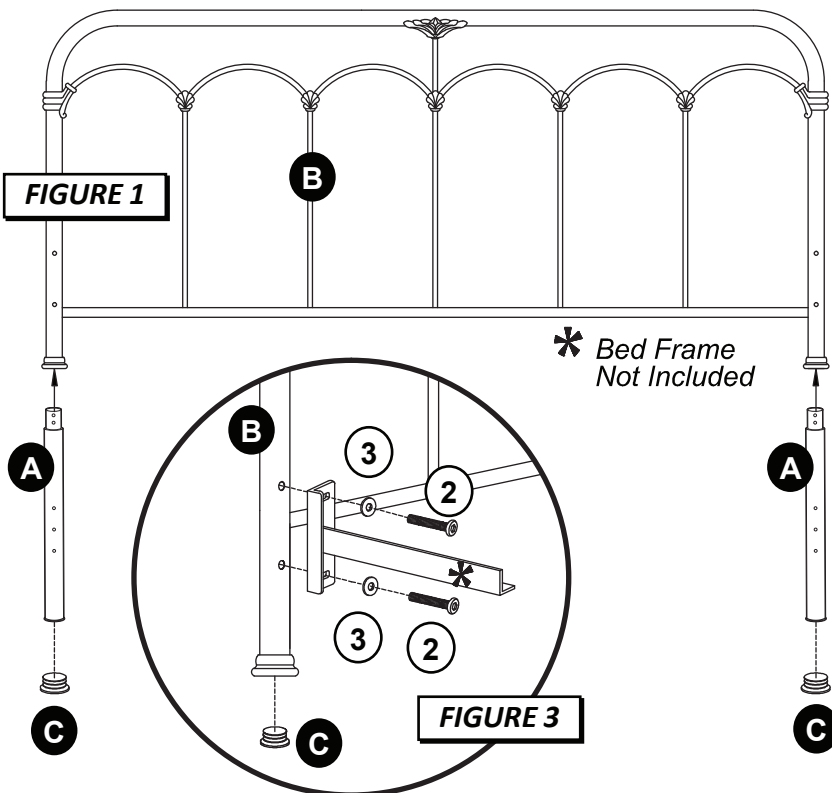

CARE & MAINTENANCE: The touch of a soft cloth is all the maintenance the finish will ever need. Please do not use harsh or abrasive cleaners for polishing, as they may cause damage to the finish. Periodic checks are recommended to make sure that all hardware is securely tightened.