

# ASSEMBLY INSTRUCTION

## Component List

**A** Table Top

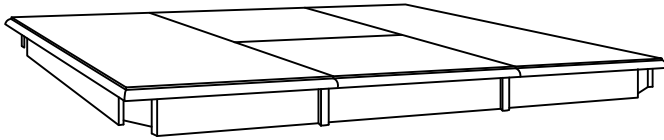

1pc

**B** Table Leg

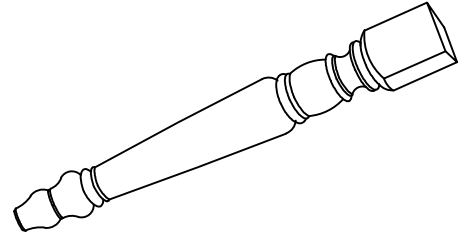

4pcs

## Hardware List

**1** Hex Nut  $\phi 5/16"$

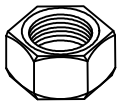

8pcs

**2** Lock Washer  $\phi 5/16"$

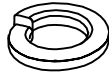

8pcs

**3** Flat Washer  $\phi 5/16"$

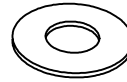

8pcs

**4** Wrench #12.8



1pc

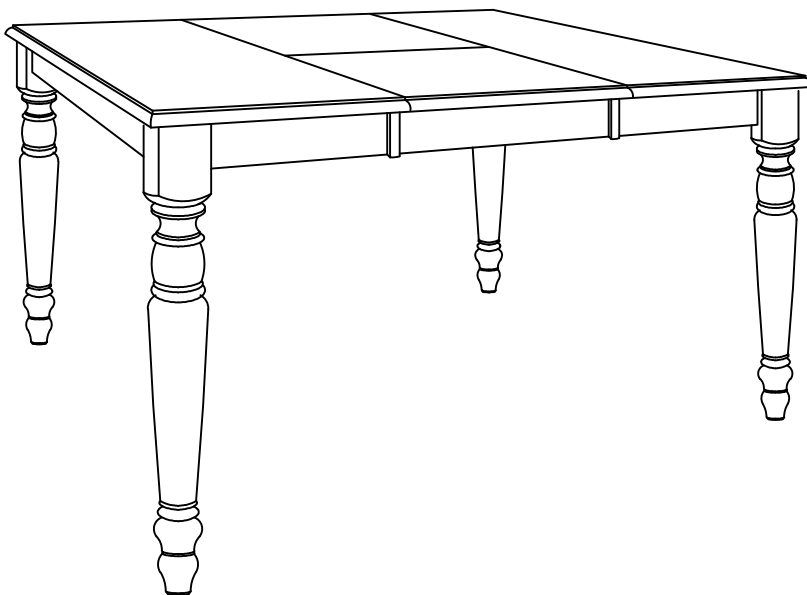

This page lists all the contents included in the box. Please take the time to identify the hardware as well as the individual components to this product. As you unpack and prepare for assembly, place the contents on a carpeted or padded area to protect them from damage.

1

Turn the Table Top (A) upside down on a soft surface such as carpet. Fix the Table Leg (B) to the corner of the apron by using Flat Washer (3), Lock Washer (2), Hex Nut (1) and tighten with Wrench (4) as per illustration.

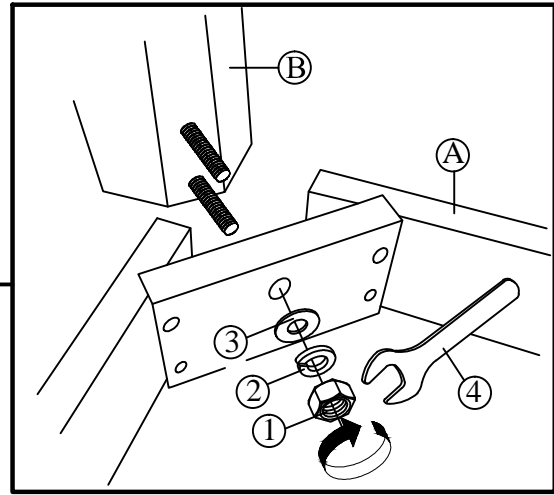
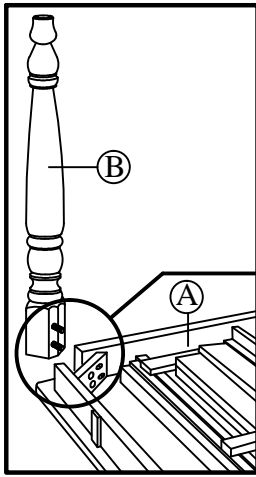

2

Turn the Table unit upright.

(Fig.A)

Open the hook at underneath of the top assembly. Pull out the leaves as show in the illustration.

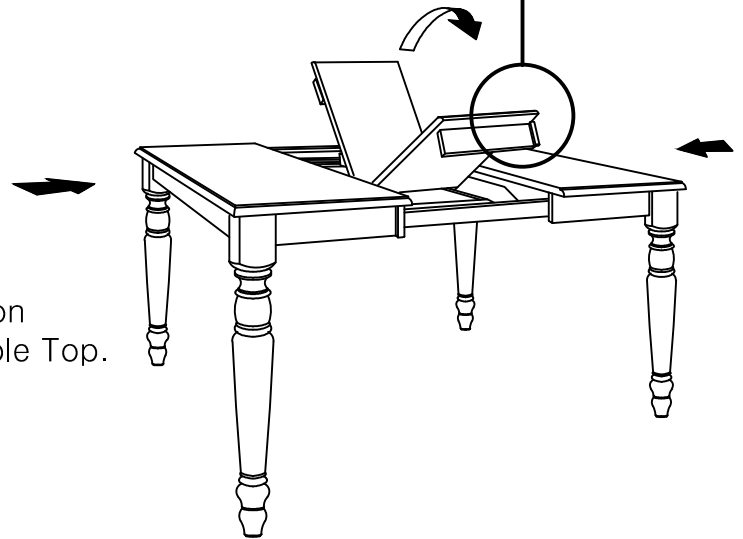
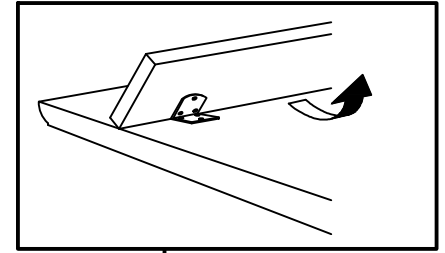
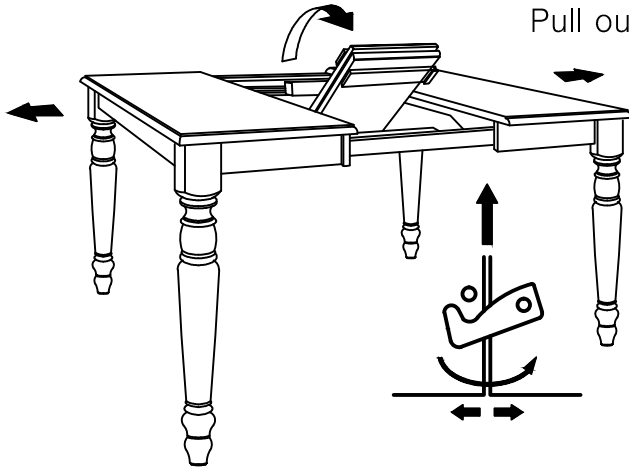

(Fig.B)

Raise the leaves apron and close up the Table Top.

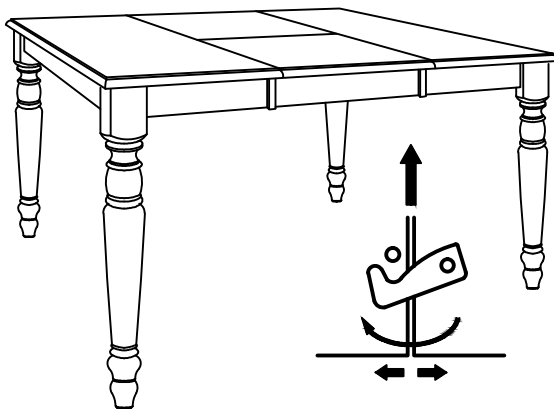

(Fig.C)

Fix the leaves by locking back the hook at underneath of the top assembly.

### Cleaning & Care

Treat surface with care. Surface is resistant to scratches but is not scratch resistant. Clean surface with a dry or damp soft cloth. Do not use abrasive cleaners. Hardware may loosen over time. Periodically check that all connections are tight.