

CARE AND MAINTENANCE



















Store outdoor furniture indoors or cover well when not in use.
Remove wooden furniture from standing water. Dust regularly with small brush or vacuum
Spills should be taken care of immediately before they harden or stain with a slightly dampened sponge.

NOTICE

- * Please make sure that you have all parts indicated before you begin assembly of this item
- * This item should be assembled on a soft surface to prevent scratching the finish during assembly
- * This item may require periodic tightening

**Weight Capacity : 275 lbs (single seat)
550 lbs (towperson seat)**
Warning : Do not stand on chair
Warning : Do not over torque bolts/screws

Part List and Hardware List

| PIECE | DESCRIPTION | PICTURE | QUANTITY |
|-------|-------------------------|-------------------------------------------------------------------------------------|----------|
| 1 | Chair/Bench left frame |  | 3X |
| 2 | Chair/Bench right frame |  | 3X |
| 3 | Bench seat frame |  | 1X |
| 4 | Chair seat frame |  | 2X |
| 5 | Bench back frame |  | 1X |
| 6 | Chair back frame |  | 2X |
| 7 | Table top |  | 1X |
| 8 | Right leg table |  | 1X |
| 9 | Left leg table |  | 1X |
| 10 | Table botton frame |  | 1X |
| 11 | Bench seat cushion |  | 1X |
| 12 | Chair seat cushion |  | 2X |
| 13 | Table glass |  | 1X |
| A | Allen bolt(M6x20 mm) |  | 4X |
| B | Allen bolt(M6x30 mm) |  | 10X |
| C | Allen bolt(M6x40 mm) |  | 24X |
| D | Allen bolt(M6x60 mm) |  | 6X |
| E | Flat washer |  | 44X |
| F | Allen key |  | 3X |



Product Dimensions:

42.51"x20.86"x31.49" H (Bench)
22.44"x20.86"x31.49" H (Chair)
26.77"x14.96"x16.14" H (Table)

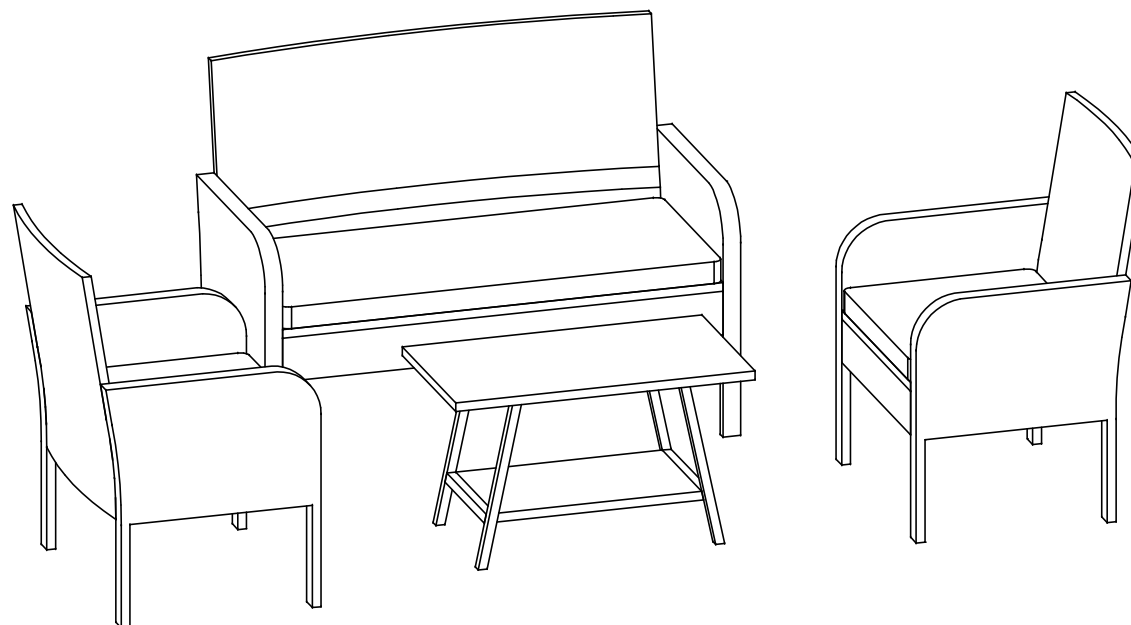

CARE AND MAINTENANCE

Store outdoor furniture indoors or cover well when not in use.
Remove wooden furniture from standing water. Dust regularly with small brush or vacuum
Spills should be taken care of immediately before they harden or stain with a slightly dampened sponge.

NOTICE











- * Please make sure that you have all parts indicated before you begin assembly of this item
- * This item should be assembled on a soft surface to prevent scratching the finish during assembly
- * This item may require periodic tightening

**Weight Capacity : 275 lbs (single seat)
550 lbs (towperson seat)**

Warning : Do not stand on chair

Warning : Do not over torque bolts/screws

Part List and Hardware List

| PIECE | DESCRIPTION | PICTURE | QUANTITY |
|-------|-------------------------|-------------------------------------------------------------------------------------|----------|
| 1 | Chair/Bench left frame |  | 2X |
| 2 | Chair/Bench right frame |  | 2X |
| 4 | Chair seat frame |  | 2X |
| 6 | Chair back frame |  | 2X |
| 12 | Chair seat cushion |  | 2X |
| B | Allen bolt(M6x30 mm) |  | 4X |
| C | Allen bolt(M6x40 mm) |  | 14X |
| D | Allen bolt(M6x60 mm) |  | 4X |
| E | Flat washer |  | 22X |
| F | Allen key |  | 1X |

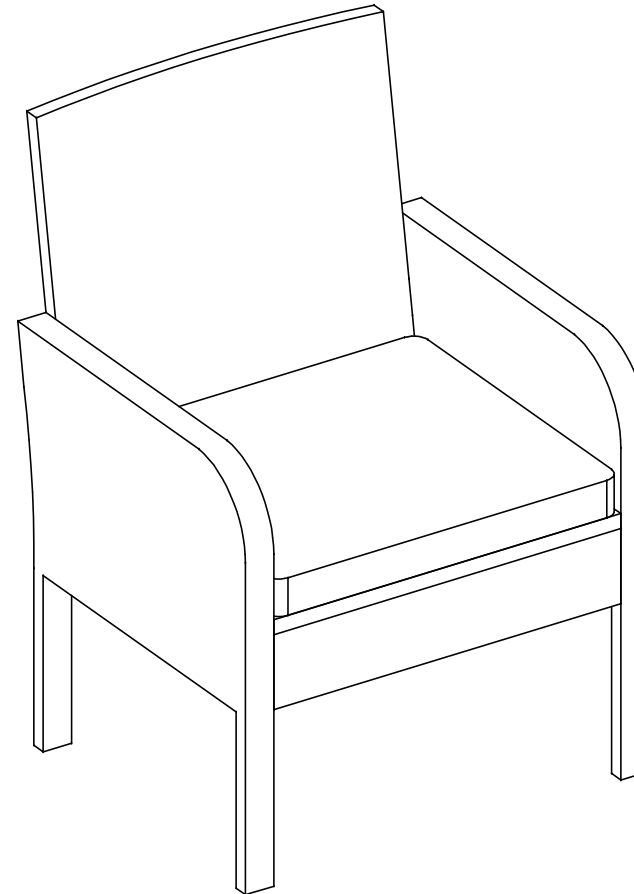

1 x2

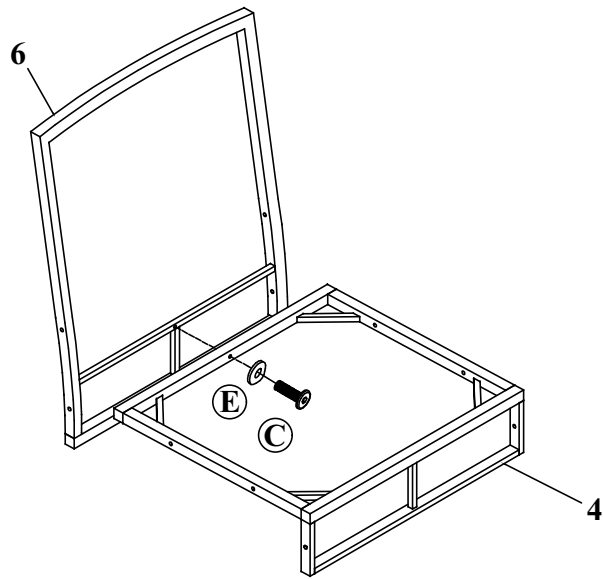

Step 1
 Connect Chair back frame (6) & Chair seat frame (4), tighten Bolt (C) with Allen Key (F)

2 x2

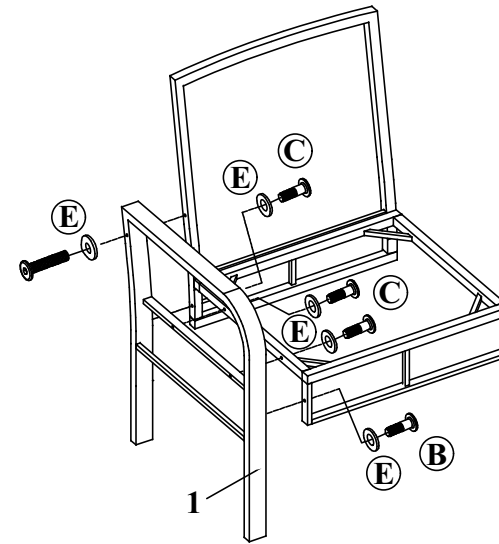

Step 2
 Connect part from Step 1 & Left frame (1), tighten Bolt (B), Bolt (C) & Bolt (D) with Allen key (F)

3 x2

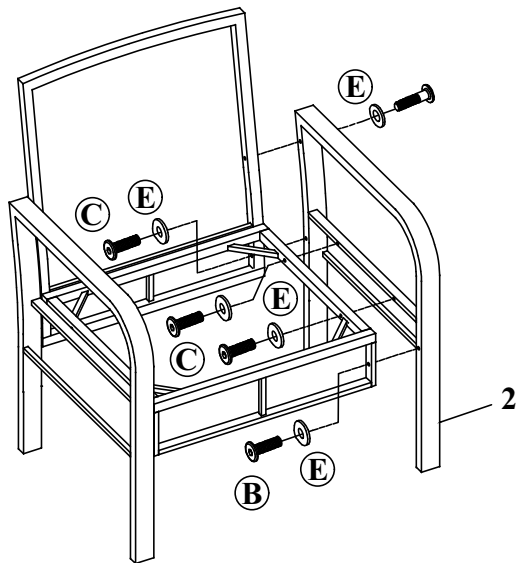

Step 3
 Connect part from Step 2 & Right frame (2), tighten Bolt (B), Bolt (C) & Bolt (D) with Allen key (F)

4 x2

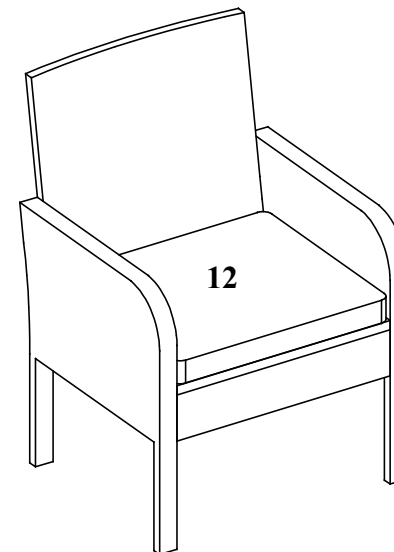

Step 4
 Put on Chair seat cushion (12) to complete Chair