



**INSTRUCTIONS D'ASSEMBLAGE  
ASSEMBLY INSTRUCTIONS**

---

**M**ONARCH  
SPECIALTIES INC.

# I 2010

---

**PATERE -  
72"H / STYLE CONTEMPORAIN METAL NOIR**

**COAT RACK -  
72"H / BLACK METAL CONTEMPORARY STYLE**





**POUR DE L'ASSISTANCE OU POUR COMMANDER  
DES PIÈCES CONTACTEZ NOTRE DÉPARTEMENT  
DE SERVICE À LA CLIENTÈLE.**

**FOR ASSISTANCE OR TO ORDER PARTS  
CONTACT OUR CUSTOMER SERVICE DEPARTMENT**

**WWW.MONARCHSERVICE.COM**

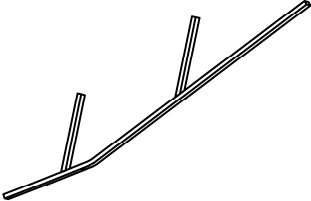
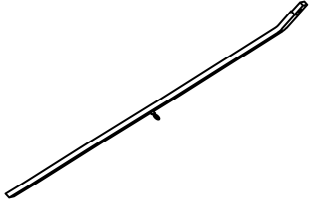
**LISTE DES PIÈCES**  
**PARTS LIST**

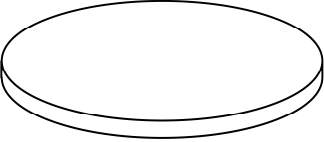
PIÈCE / PART #	IMAGE	DESCRIPTION	QTY / QTÉ
1		<p>UPPER POST POTEAU SUPÉRIEUR</p>	3
2		<p>BOTTOM POST POTEAU DU BAS</p>	3
3		<p>POST CONNECTOR CONNECTEUR DE POTEAU</p>	1
4		<p>SHELF PANEL PANNEAU DE TABLETTE</p>	1

**LISTE DES PIÈCES DE MONTAGE**  
**HARDWARE LIST**

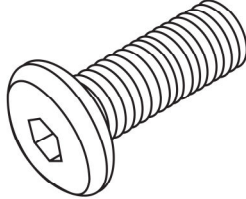
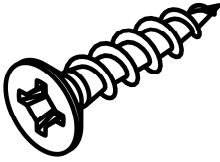
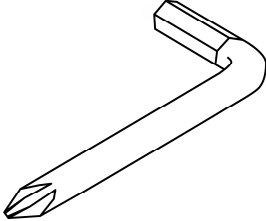
PIÈCE / PART #	IMAGE	DESCRIPTION	QTY / QTÉ
A		<p>ASSEMBLING BOLT - Ø1/4" X 7/8"</p> <p>BOULON D'ASSEMBLAGE - Ø1/4" X 7/8"</p>	6
B		<p>ASSEMBLING SCREW - Ø1/4" X 1/2"</p> <p>VIS D'ASSEMBLAGE - Ø1/4" X 1/2"</p>	3
C		<p>HEX KEY</p> <p>CLÉ HEXAGONALE</p>	1



OUTIL DE VÉRIFICATION DE DIMENSIONS DES PIÈCES  
HARDWARE DIMENSIONS VERIFICATION TOOL



ÉTAPE / STEP 1

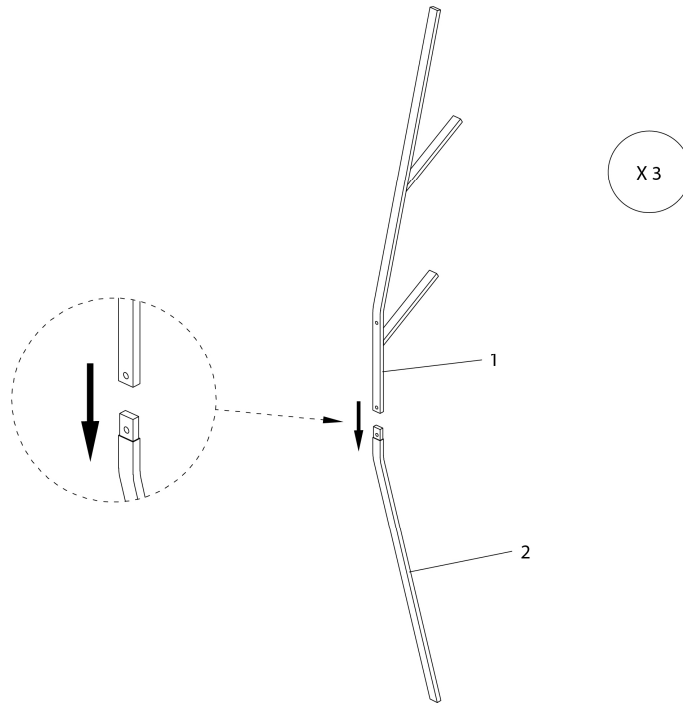

ÉTAPE / STEP 2

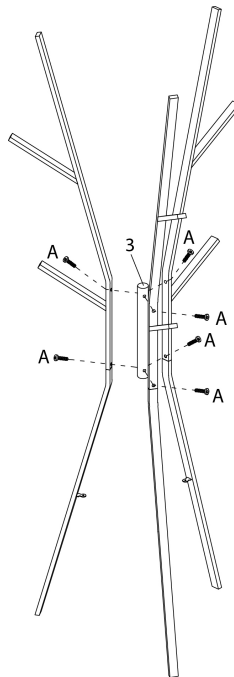

ÉTAPE / STEP 3

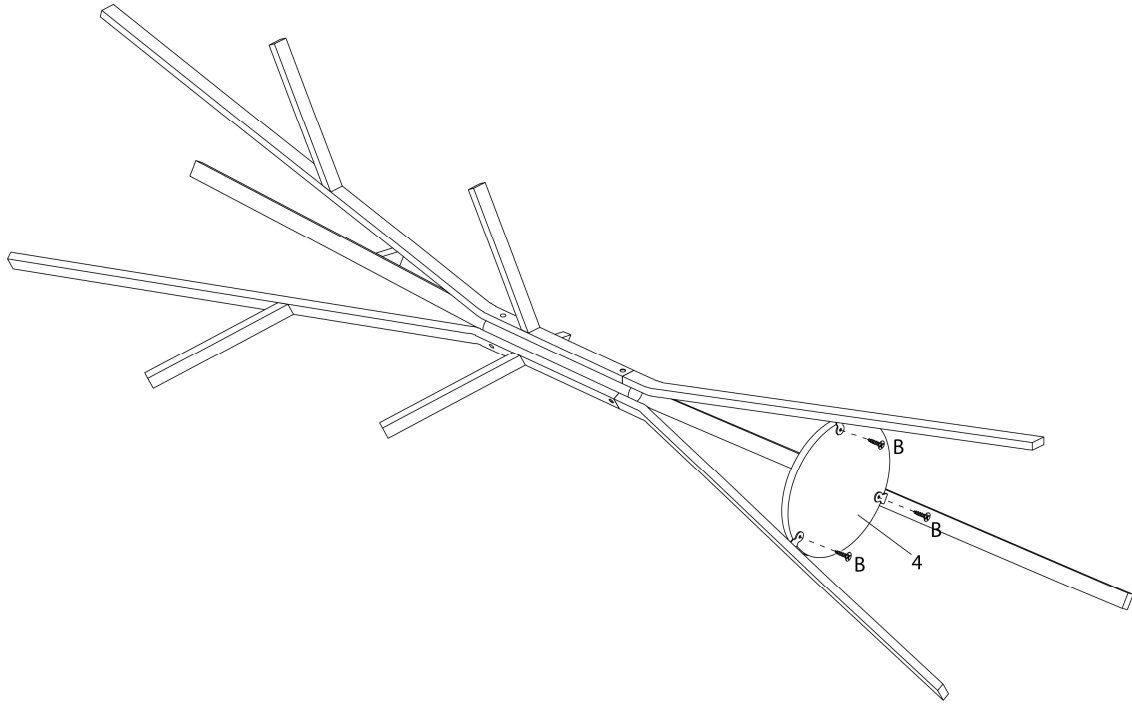

ÉTAPE / STEP 4

