

Manual

Book

Crystal chandelier





Please contact us in following format:

1. Order platform name and Order ID NO.
2. Problem details with picture / video if possible

Safety Rules

WARNING: BE SURE THE ELECTRICITY TO THE WIRES YOU ARE WORKING IN IS SHUT OFF; EITHER THE FUSE IS REMOVED OR THE CIRCUIT BREAKER IS TURNED OFF. TURNING THE POWER OFF USING THE LIGHT SWITCH IS NOT SUFFICIENT TO PREVENT ELECTRICAL SHOCK.

NOTE: The important safeguards and instructions appearing in this manual are not meant to cover all possible conditions or situation that may occur. It must be understood that common sense, caution, and care, are factors which cannot be built into any product. These factors must be supplied by the person(s) installing this unit.

READ & SAVE THESE INSTRUCTIONS

CAUTION: Before assembling the lighting fixture, refer to the section titled Wiring Connections. If you feel you do not have enough electrical wiring experience, either refer to a do-it-yourself wiring handbook or have your lighting fixture installed by a qualified, licensed electrician.

UNPACK THE PACKAGE

Check the contents to be sure everything is included

Tools Needed: Slotted screwdriver, Adjustable wrench, Step ladder, Wire cutters, wiring supplies as required by electrical code.

INSTALLATION & OPERATION INSTRUCTIONS GENERAL

Before starting the installation, disconnect the power by turning off the circuit breaker or by removing the appropriate fuse at the fuse box. Turning the power off using the light switch is not sufficient to prevent electrical shock. All electrical connections must be in accordance with local and National Electrical Code (NEC) standards. If you are unfamiliar with proper electrical wiring connections, obtain the services of a qualified electrician.

Remove the fixture and the mounting packages from the box and make sure that no parts are missing by referencing the illustrations on the installation instructions.

Be sure to read these installation instructions and review the diagrams thoroughly before installation.

LIGHT BULBS REQUIRED

This fixture uses G9 bulb base, works with incandescent, LED, CFL, halogen or color changing bulbs up to 40W. Fully dimmable when used with dimmable bulbs and a compatible dimmer switch (not included).

1. Installation Preparation

Tools You Need



Ladder



Pliers



Wire
Strippers

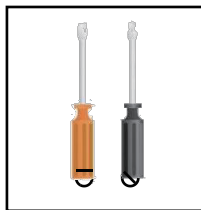

Screwdrivers



Power Drill
(optional)

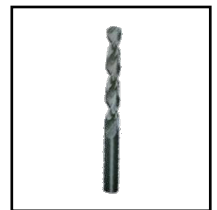

Drill bit
(optional)

If mounting to a support structure, you will also need the optional tools.

2. Mounting & Wiring

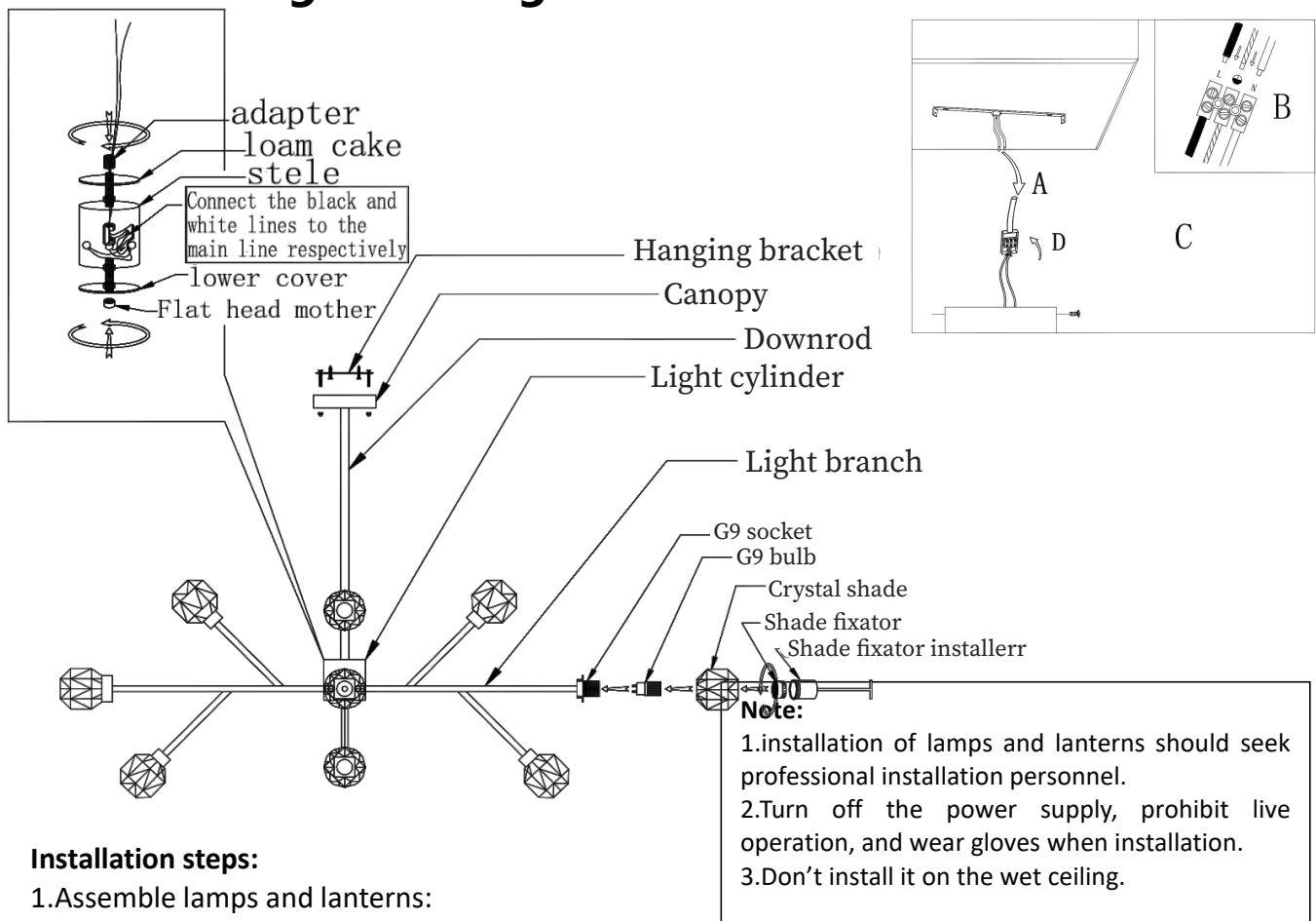

Installation steps:

1.Assemble lamps and lanterns:

In accordance with the installation instructions,all parts should be connected together. The length of the threads in the lamp should be suitable. The threads of multiple threads should be dipped in tin. The color of the wiring should be unified so as to make it easy to distinguish between the fire line and the zero line and straighten out the inner line of the lamp.

2.Installation of lamps and lanterns:

Installation of ordinary lamp holder: Cut off the remaining wires and strip out the wire holder after reserving enough maintenance length, and install the lamp holder one the junction box with connecting screw.

Installation of off-line lamp holder: Cut off the remaining wires and strip the wire head after leaving enough maintenance length of the power cord, and fix the lamp holder on the junction box with connecting screw through the lamp holder base. Take a section of lamp cord and connect it to the lamp head at one end. Inside the lamp head, fasten the safety buckle and put the other end of the lamp line into the base cover bowl. Inside the cover bowl, fasten the safety buckle and screw the buckle bowl with the power cord on the base.

3.Power-on Trial Operation

Turn on the power supply and test whether it is on.

Trouble Shooting

1. Missing/Broken Parts

- Make a list of the missing/broken parts according to the packing list, take photos for broken parts, then email us for free replacements.

2. Bulbs Do Not Light Up

- Check your power and switch to make sure it's power on.
- Check the bulb to make sure it's installed correctly.
- Change a new bulb.
- Check the wires to make sure they are connected correctly

3. Bulbs Flicker/Noisy Operation

- Check the bulb to make sure it's installed correctly.
- Change a new bulb.
- Make sure your bulb is dimmable if you use a dimmer switch.

4. Could Not Install/Assemble

- Take photos of the ceiling/fixture, contact seller for technical support.

Clean And Care

To clean, wipe fixture with soft cloth. Spray from chemical cleaners can discolor the finish of fixture. Do not use scouring pads, powders, steel wool or abrasive paper to clean this fixture. When cleaning, please turn off the power supply and use non-corrosive detergent for cleaning.

Ordering Parts

Keep this manual for future reference, and in case replacement parts are needed. Available parts can be ordered from place of purchase. Use exact wording from diagrams when ordering parts.



7.88"
11.81"



43.31"

118"

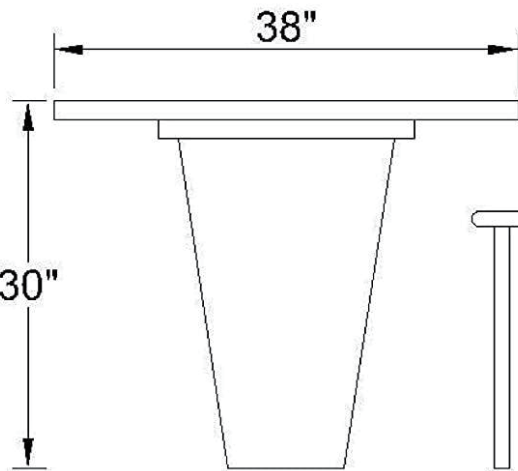

38"

30"

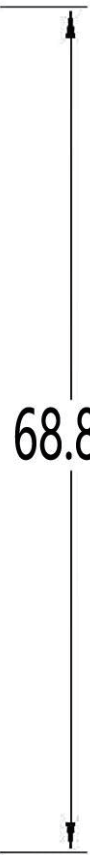
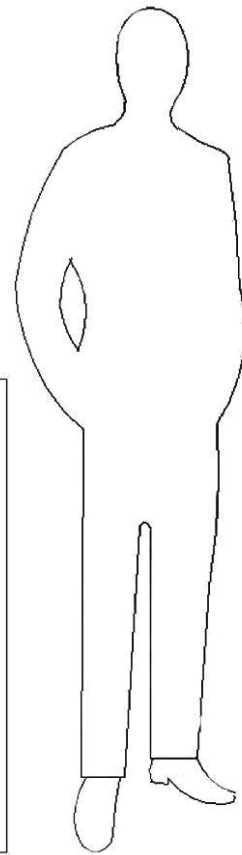
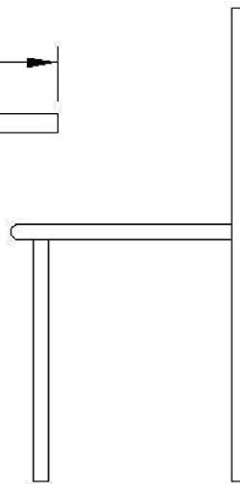

68.89"

“There's always a light on for you.”