

Instruction Manual

6-CUBE LADDER

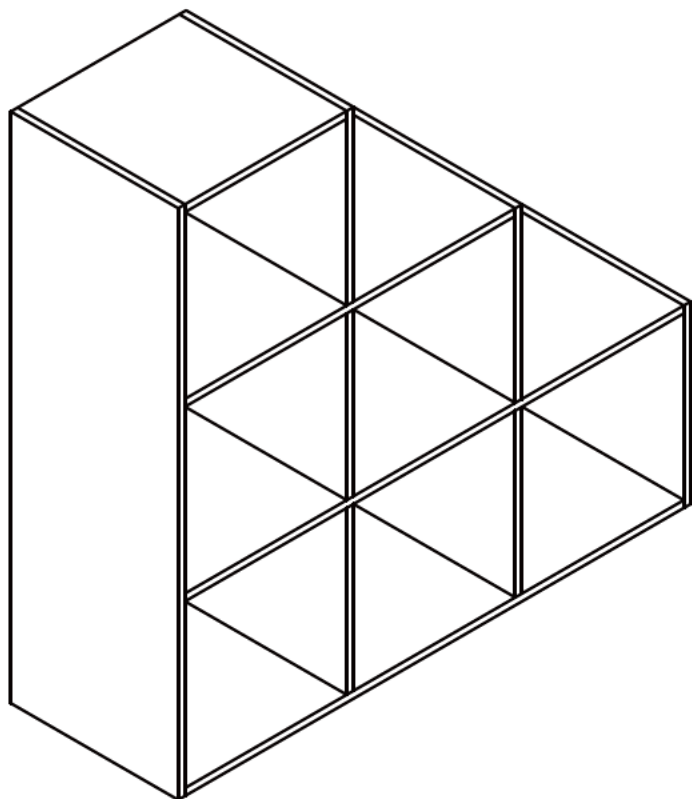

CONTENTS

Safety and care advice	1
Components – panels	2
Components – fittings	3
Assembly instructions	4
Copyright	16

⚠ SAFETY AND CARE ADVICE ⚠

PLEASE READ THESE INSTRUCTIONS CAREFULLY AND KEEP FOR FUTURE REFERENCE

Warning: Please lift with care.

- Check you have all the components and tools listed on pages 2 and 3.
- Remove all fittings from the plastic bags and separate them into their groups.
- Keep children and animals away from the work area, small parts could choke if swallowed.
- Make sure you have enough space to layout the parts before starting.
- Do not stand or put weight on the product, this could cause damage.
- Assemble the item as close to its final position (in the same room) as possible.
- Assemble on a soft level surface to avoid damaging the unit or your floor (use opened out unit carton).



·We do not recommend the use of power drill/drivers **for inserting screws**, as this could damage the unit. Only use hand screwdrivers.

·**Safety note:** If there is any chance of this unit being pulled over by children etc. it is recommended that the unit is secured to a wall using suitable fixings (not supplied).

·Dispose of all packaging carefully and responsibly.

CARE AND MAINTENANCE

- Only clean using a damp cloth and mild detergent, do no use bleach or abrasive cleaners.
- From time to time check that there are no loose screws on this unit.

·This product should not be discarded with household waste. Take to your local authority waste disposal center.

Note: *If required the next page can be cut out and used as reference throughout the assembly. Keep this page with these instructions for future reference*

COMPONENTS — PANELS

Please check you have all the panels listed below:



2 PERSON
ASSEMBLY
RECOMMENDED

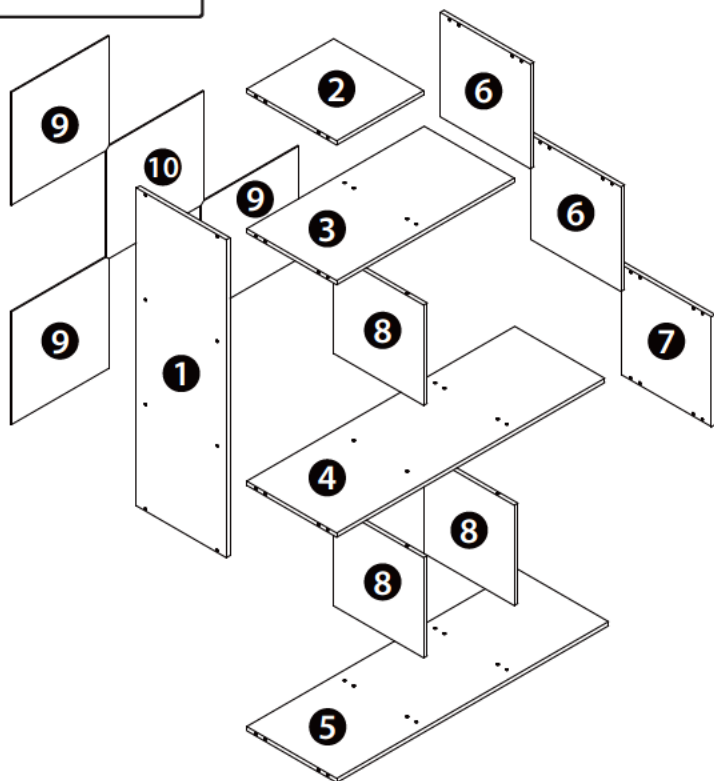

PANEL LIST

1	Left Side Panel	x1	6	Right Side Panel	x2
2	Top Panel	x1	7	Vertical Panel	x1
3	Shelf Panel	x1	8	Vertical Panel	x3
4	Shelf Panel	x1	9	Back Panel	x3
5	Bottom Panel	x1	10	Back Panel	x1



COMPONENTS — FITTINGS

Please check you have all the fittings listed below:

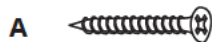

Screw x 24



Screw x 1



Hole cover x 20

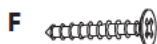

Screw x 2



Wooden Dowel x 22



Wooden Dowel x 6



Safety Device x 1



Screw x 32

TOOLS NEEDED
(We don't provide)



Phillips Screwdriver x 1





Hammer x 1





ASSEMBLY INSTRUCTIONS

Step 1

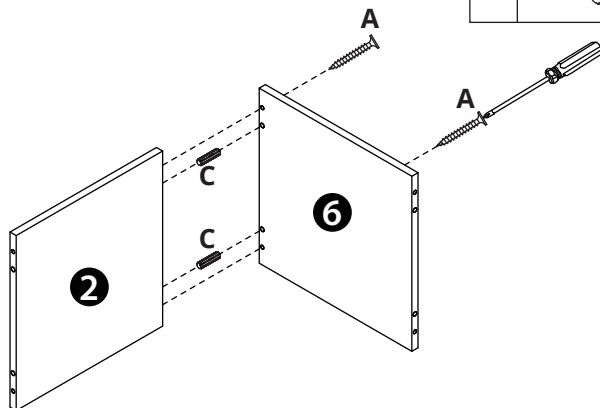
A		2	
C		2	



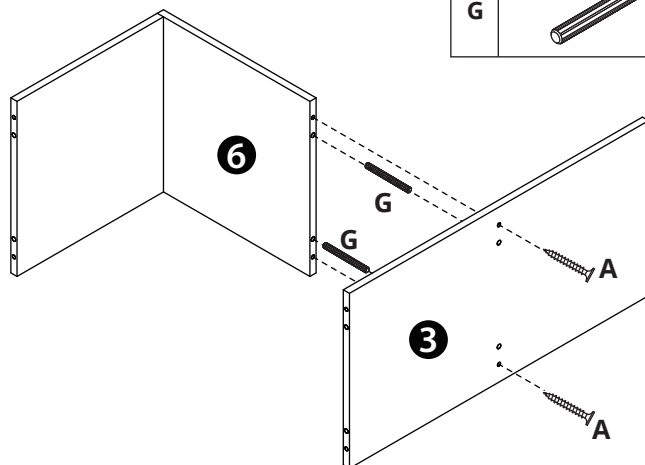

Step 2

A		2	
G		2	



ASSEMBLY INSTRUCTIONS

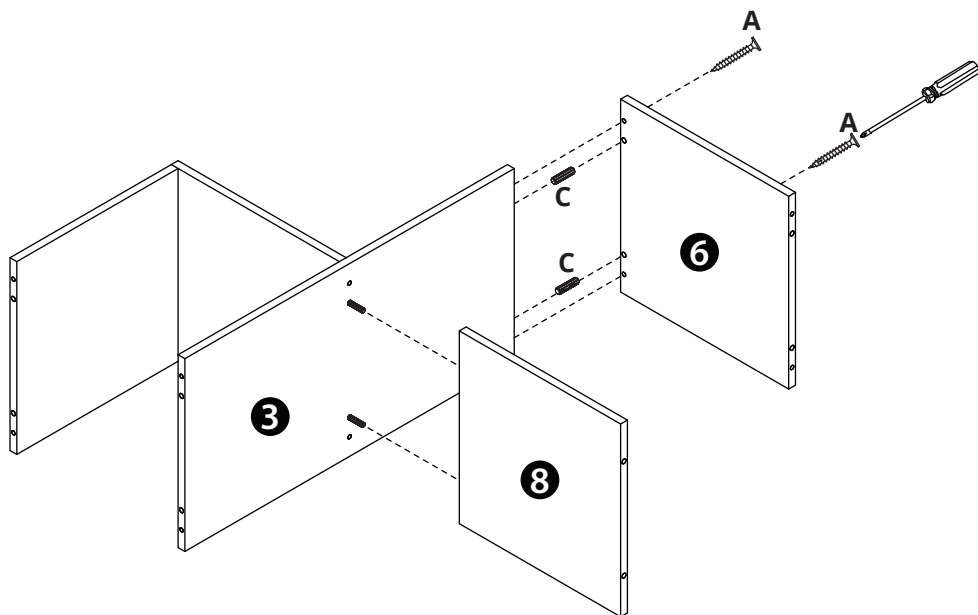

Step 3

A		2	
C		2	



ASSEMBLY INSTRUCTIONS

Step 4

A		2	
G		4	

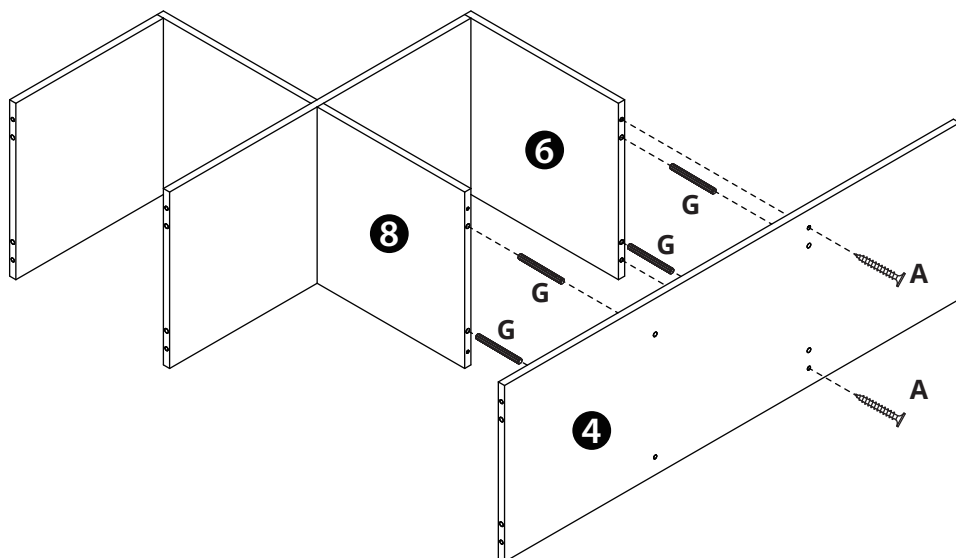

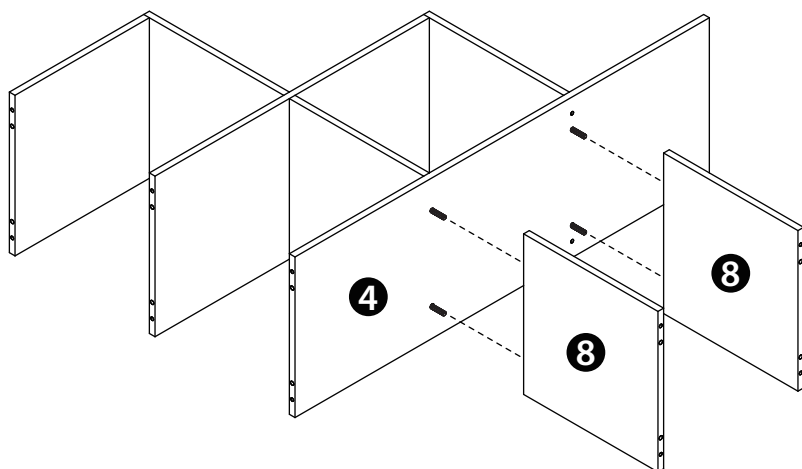

ASSEMBLY INSTRUCTIONS

Step 5



ASSEMBLY INSTRUCTIONS

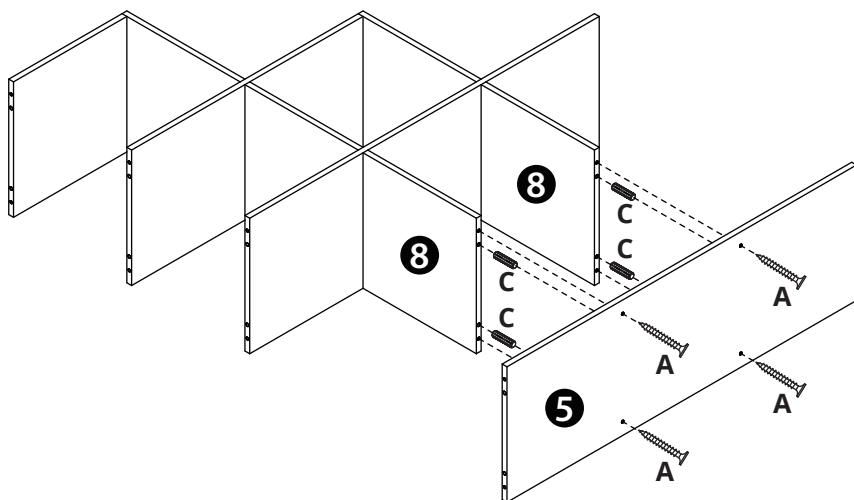

Step 6

A		4	
C		4	



ASSEMBLY INSTRUCTIONS

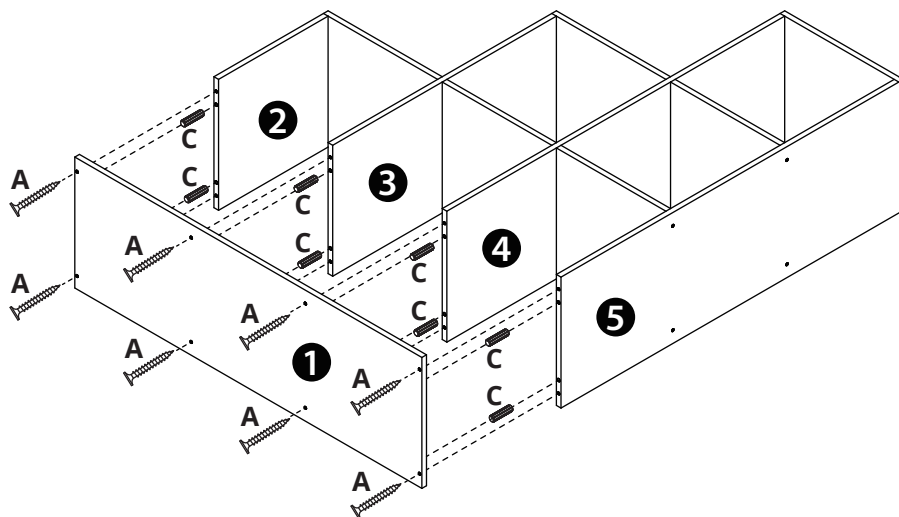

Step 8

A		8	
C		8	



ASSEMBLY INSTRUCTIONS

Step 9

H		32	
---	---	----	---

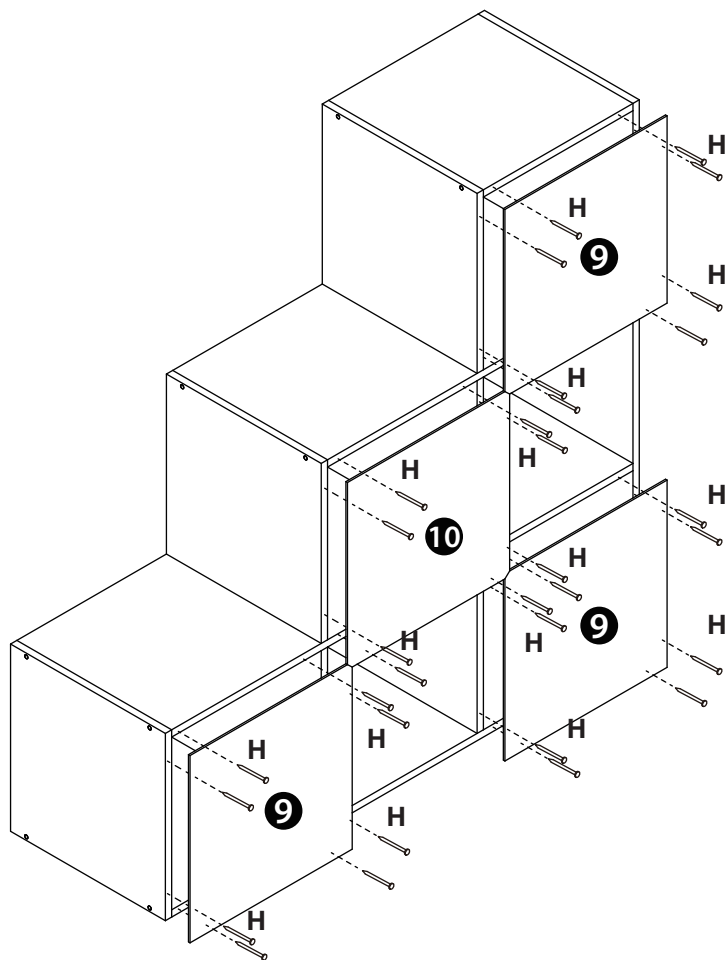

ASSEMBLY INSTRUCTIONS

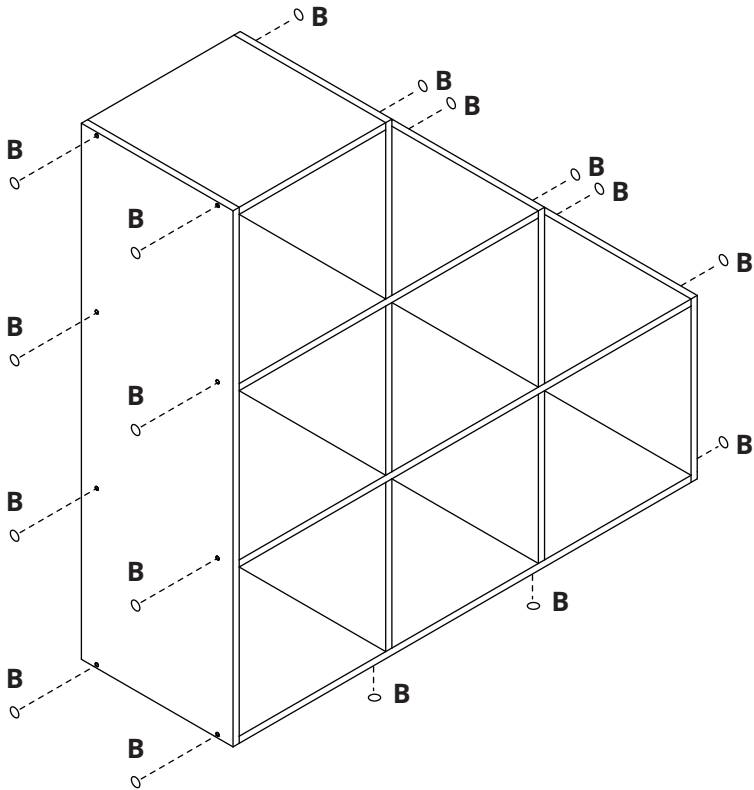

Step 10

B		20	
---	---	----	--



ASSEMBLY INSTRUCTIONS

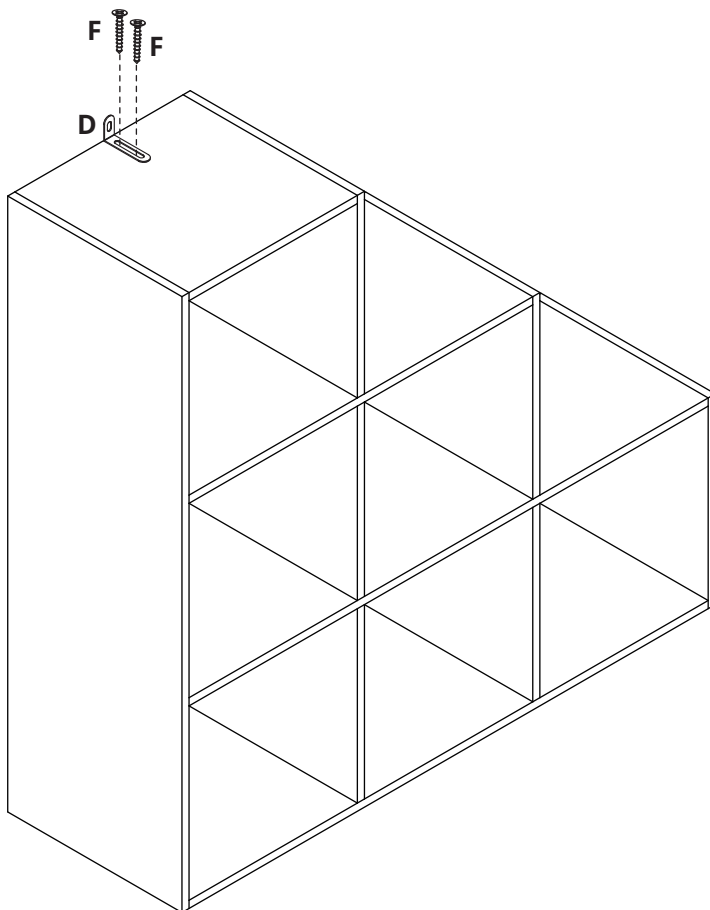

Step 11

F		2	
D		1	



ASSEMBLY INSTRUCTIONS

Step 12

H		1	
---	---	---	---

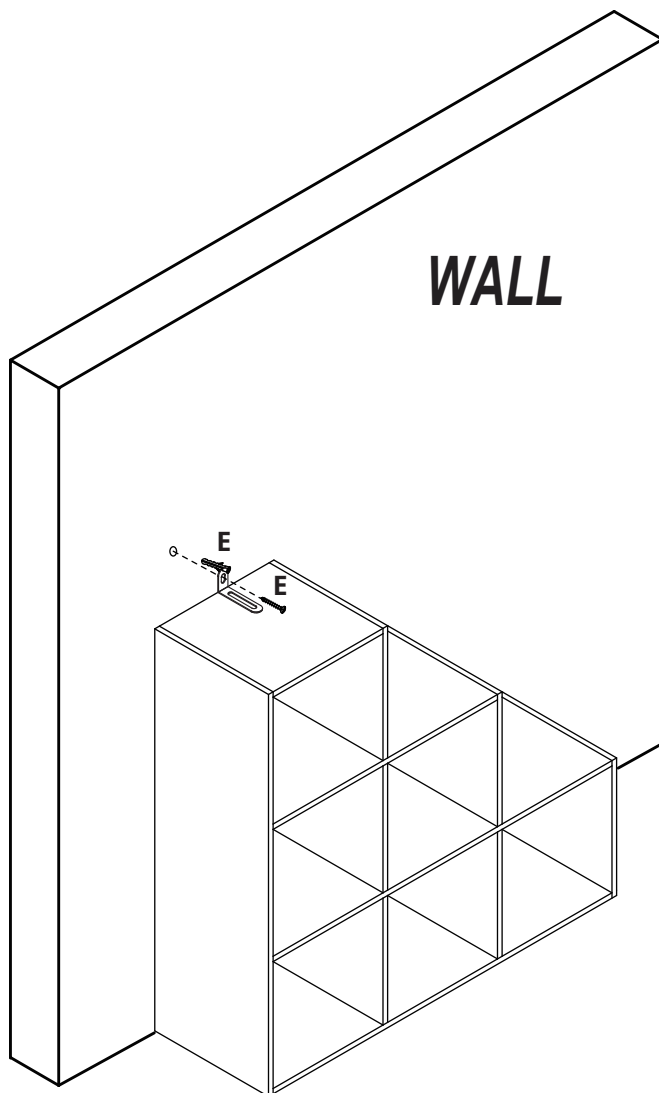

ASSEMBLY INSTRUCTIONS

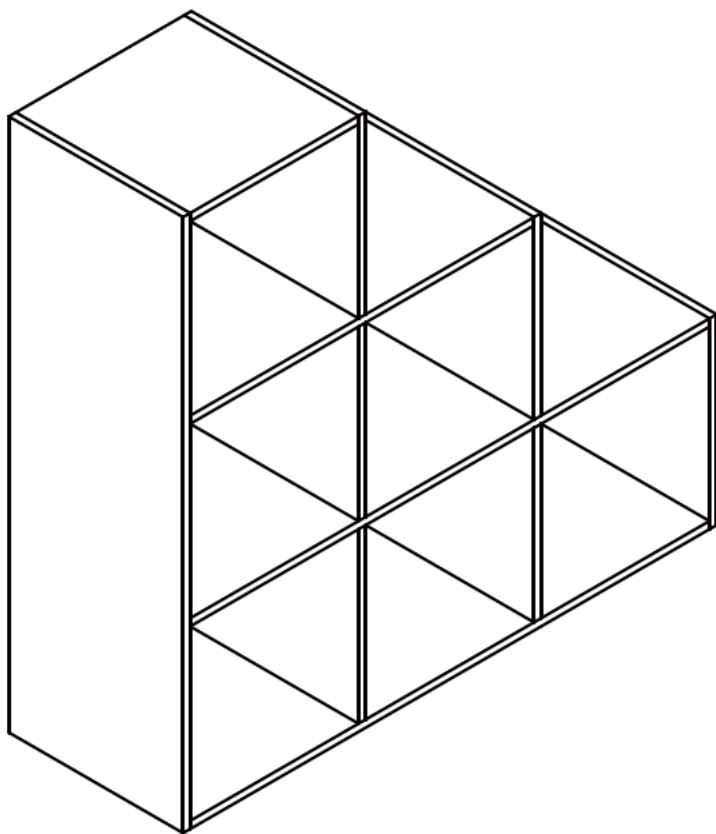

Congratulations! Now you have finished assembling the product.