

NOTE:

This brochure contains IMPORTANT safety info. Please read and keep for future reference.

MAINTAINANCE AND WARNING

- 1.Keep furniture away from heat sources.
- 2.Do not clean furniture with harsh cleaner or polishes.Do not use detergents,solvents,abrasives,spray packs or leather cleaner. Use non-color mild soa with warm water to clean spills(Mix 1:10 soap to water).
- 3.Do not place furniture under direct sunlight,material will possibly fade over time.
- 4.Do not use on site dry cleaning machine.Children should not climb or jump on the furniture.
- 5.Do not write on furniture that is not protectedby a padded barrier.
- 6.Not for commercial use,only for residential use.



Weight Limitation
250 LBS

PARTS LIST

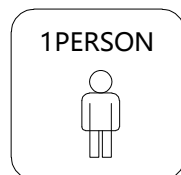
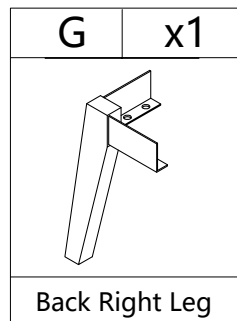
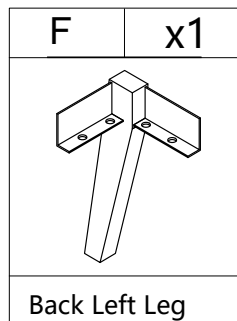
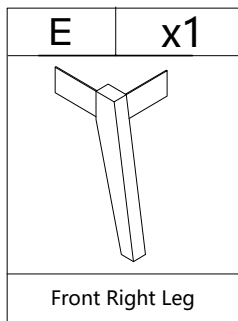
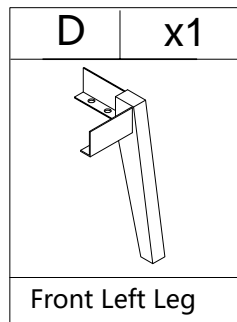
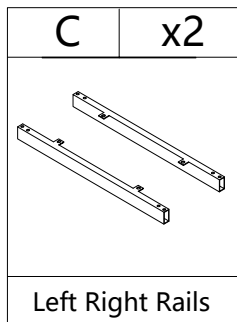
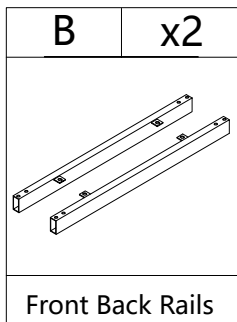
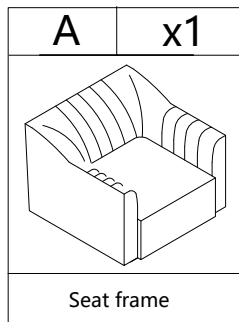

HARDWARE LIST

#1	x16
	
Bolts	
1/4*15mm	

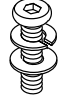
#2	x8
	
Bolts	
1/4*20mm	

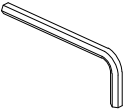
#3	x1
	
Allen Key	

HARDWARE SPARE LIST

#1	x1
	
Bolts	
1/4*15mm	

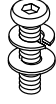
#2	x1
	
Bolts	
1/4*20mm	

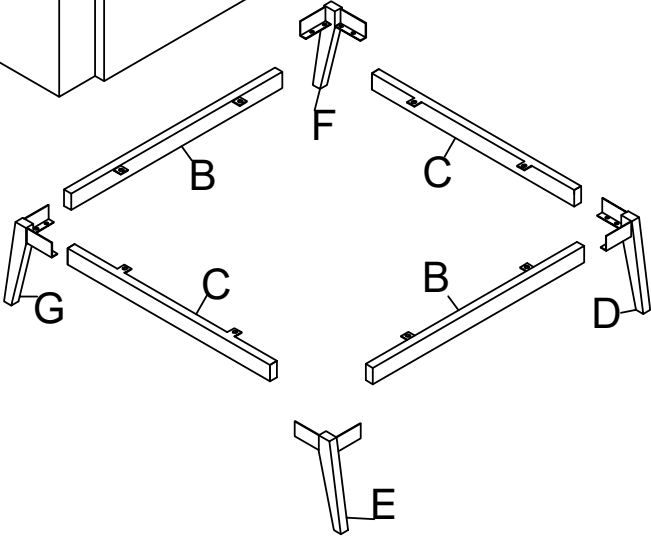
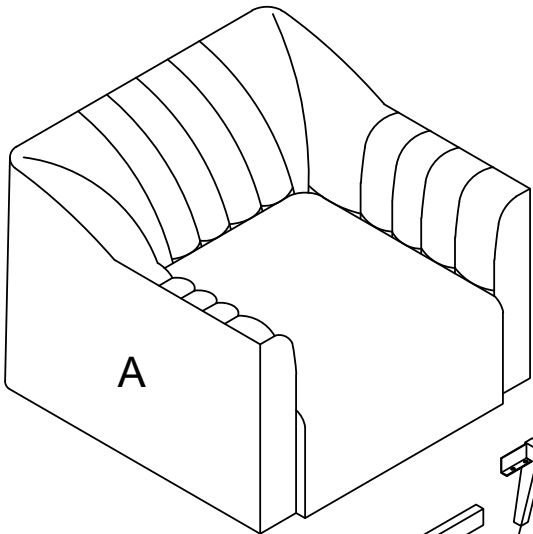

ASSEMBLY INSTRUCTIONS

STEP-1

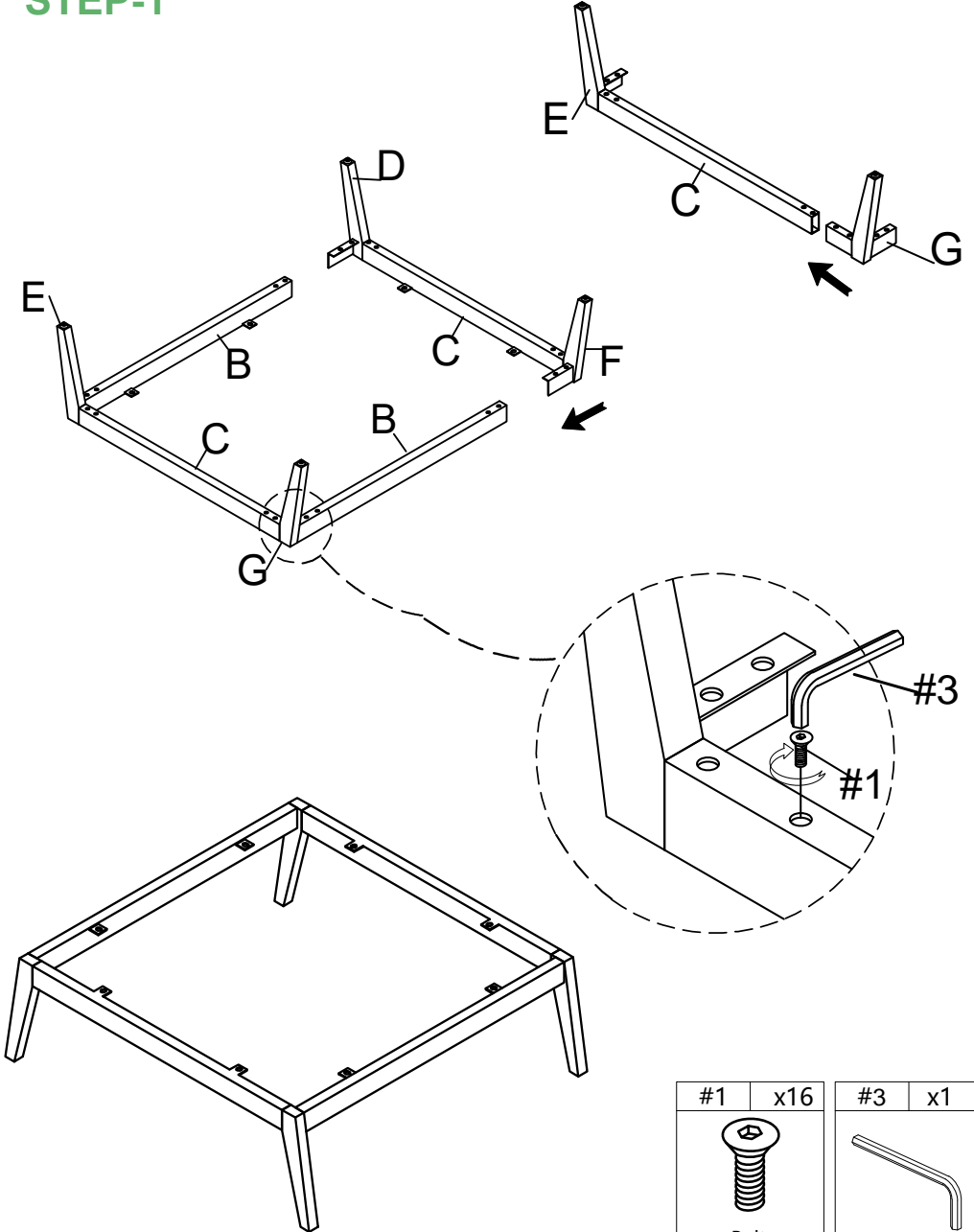

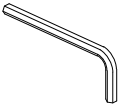
#1	x16	#3	x1
			
Bolts		Allen Key	
1/4*15mm			

ASSEMBLY INSTRUCTIONS

STEP-2

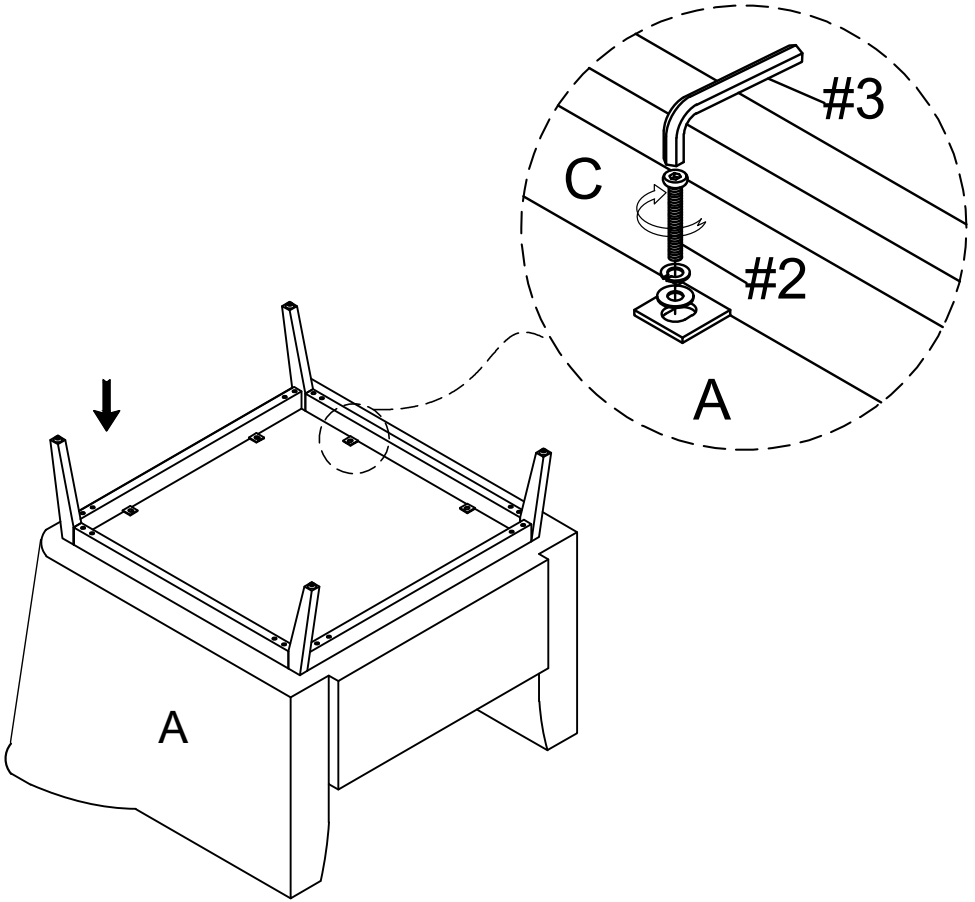

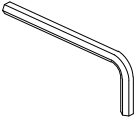
#2	x8	#3	x1
			
Bolts		Allen Key	
1/4*20mm			

ASSEMBLY INSTRUCTIONS

STEP-3

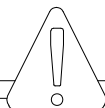

Attention:

After installation, adjust the adjustable leveler to keep the chair balanced.

Be sure to check all packing material for small parts, which may have come loose inside the carton during shipment.

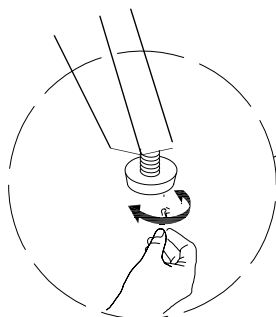
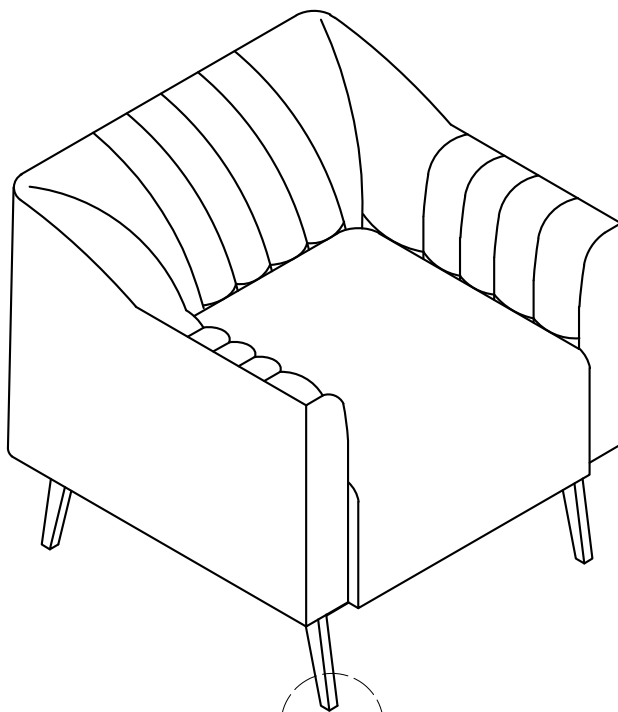

WARRANTY

1. We strive to offer high-quality products, and we also try our best to satisfy each and every customer that orders from us with product or service as needed.
2. We provide 30 days warranty starting from the time you receive the item. Each customer must provide a record of their order such as the order number, or item receipt for any items that are out of the warranty period you may also still receive.
3. Replacement parts by purchasing them with our company if they are available.