

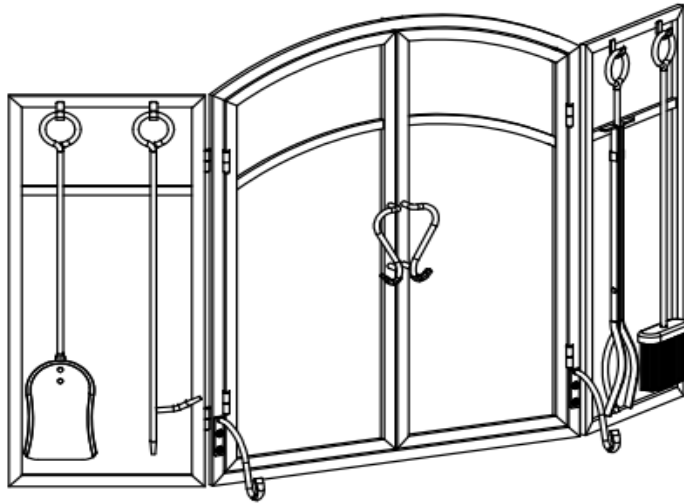



Assembly Instructions



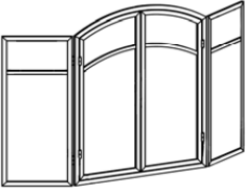

Caution : You must read this before you proceed

Fireplace screen







Parts List

Label	Picture	Description	QTY
A		Folding Screen	1
B		Feet	2
C		Left Handle	1
D		Right Handle	1

E		Shovel	1
F		Tong	1
G		Poker	1
H		Brush	1

Hardware

Label	Picture	Description	QTY
①		Bolt(M6X20mm)	9
②		Nut(M6)	5
③		Wrench	1
④		Screwdriver(Not provided)	1

Assembly Preparation

Before Beginning Assembly:

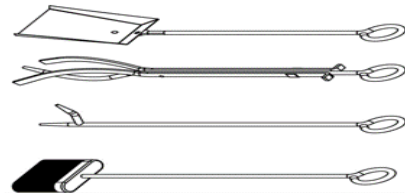
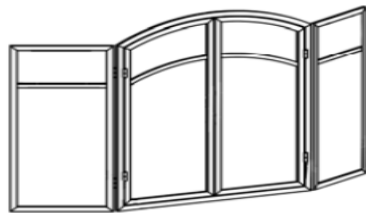

- Read instructions, cover to cover-



- Have 2 adults on hand for assembly-



- Do not assemble on flooring or carpet-



- Assemble on a clean non-marring surface (packing foam)-



- Save all packaging until finished-

Assembly Steps

Overview

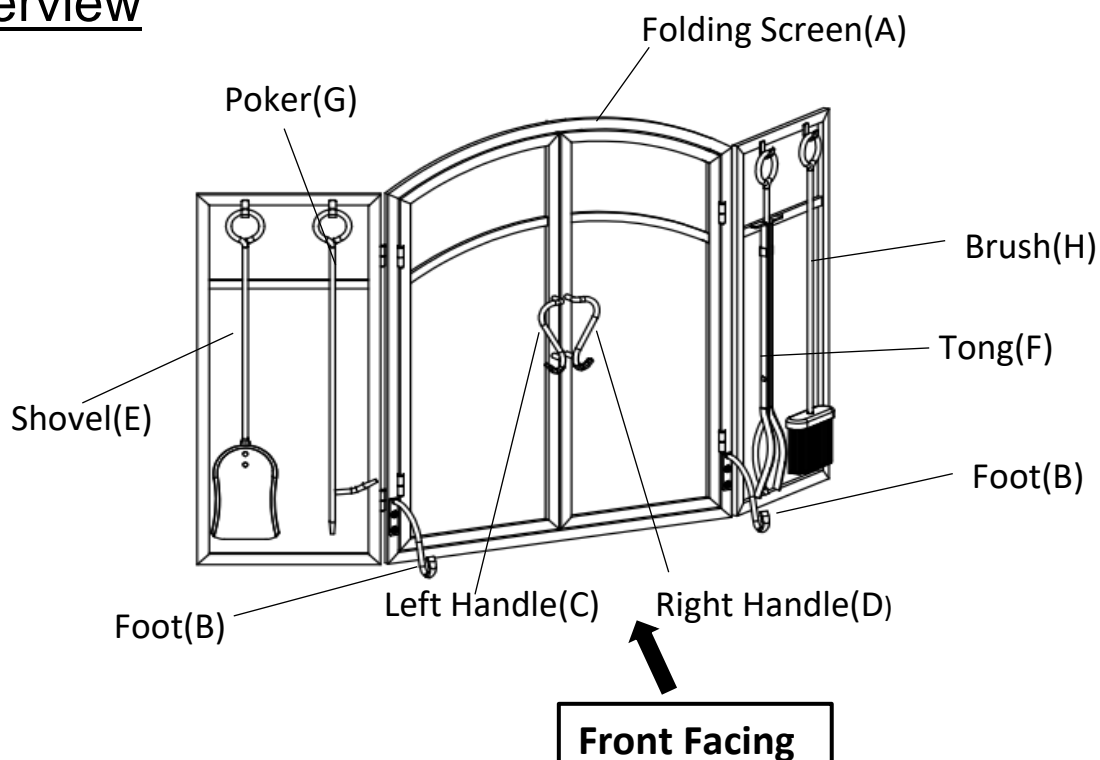

This Fireplace Screen has multiple parts and may require up to some 30 minutes to assemble. To give you an overview of the Fireplace Screen parts, the above picture is to help you put the various parts into perspective. Please read through the instructions below to familiarise yourself with the parts and steps before assembly.

Step 1

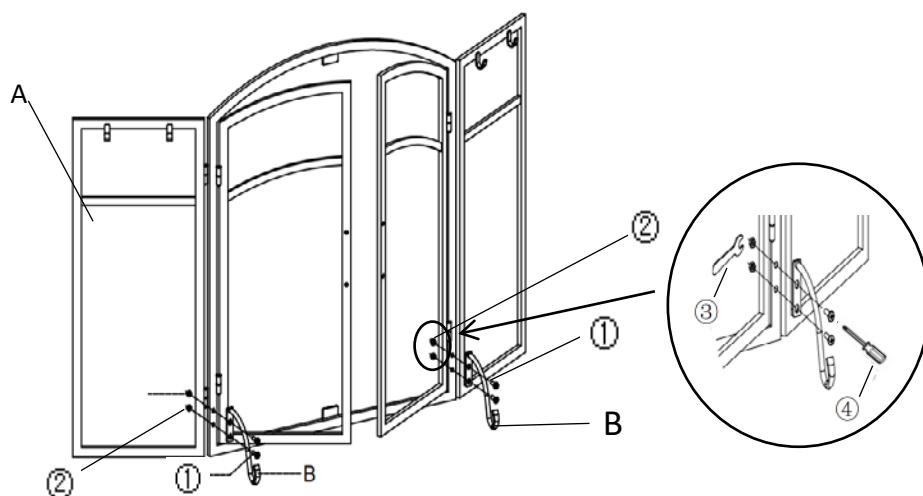

Attach the Foot(B) to Folding Screen(A) using Bolt(①) and Nut(②) with Wrench(③) and Screwdriver(④) as shown.
Repeat this step for the second Foot(B).

Step 2

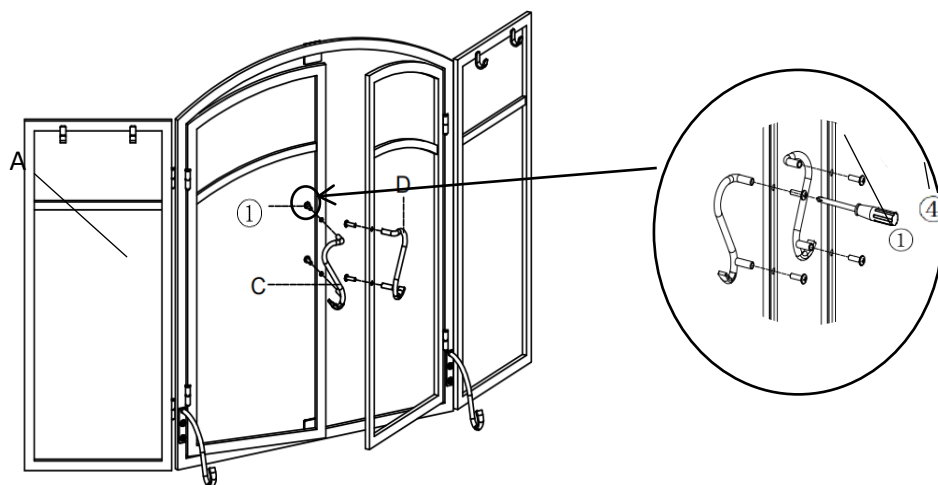

Attach the Left Handle(C) and Right Handle(D) to the Folding Screen(A) using Bolt(①) with Screwdriver(④) as shown.

Step 3

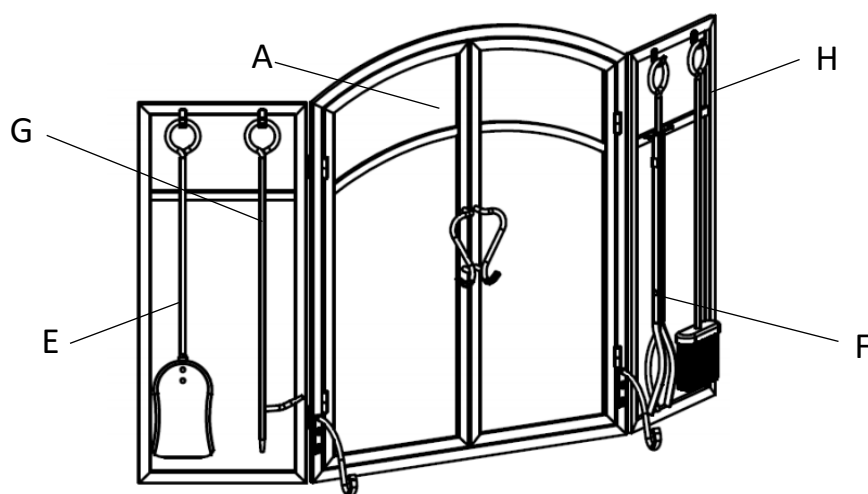





















Hang the Shovel(E),Tong(F),Poker(G) and Brush(H) on the Folding Screen(A).

Then your Fireplace Screen tool set is ready for use.

NOTICE:Make sure the opened angles of the side panels are between 90 and 120 degrees.

Care & Maintenance

-   • Do not put hot items directly on furniture surface
 -   • Do not clean furniture with harsh cleansers or polish.
 -   • Do not place furniture under direct sunlight.
 -   • Do not place furniture near heating or cooling vents.
 -   • Do not write on furniture without a padded barrier to protect the surface.
 -   • Do not place furniture outside . For indoor use only .
 -   • Not for commercial use. For residential use only .
 -   • Stains may be removed with mild soap solution and damp cloth.
 -   • Children should not climb or jump on the furniture.
-
-   • Dust and pick-up spills using a clean, non-colored, lint-free cloth .