

# Outdoor Wall Lamp

## User Manual

# INSTRUCTIONS

## TURN OFF YOUR SWITCH

**FIG.1.** Place the wall switch to the "OFF" position.

**FIG.2.** Place either the main (Master) switch to "OFF" position, cutting off power to your entire home OR turn off the individual switch that provides power to where the fixture will be installed.

**FIG.3.** Place either the main (Master) switch to "OFF" position, cutting off power to the entire home OR unscrew the fuse that provides power to where the fixture will be installed.

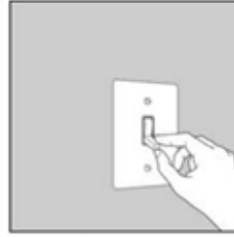

FIG.1  
WALL SWITCH

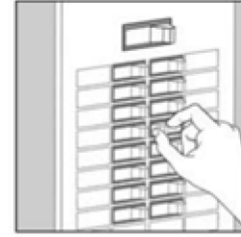

FIG.2  
BREAKER PANEL

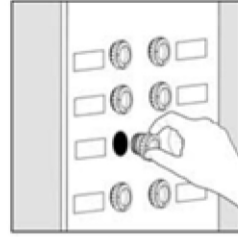

FIG.3  
FUSE BOX

## Package Included:

3\*Wire Connectors

2\*Outlet Screws

1\*User Manual

1\*Wall Sconce Light

1\*Mounting Bracket

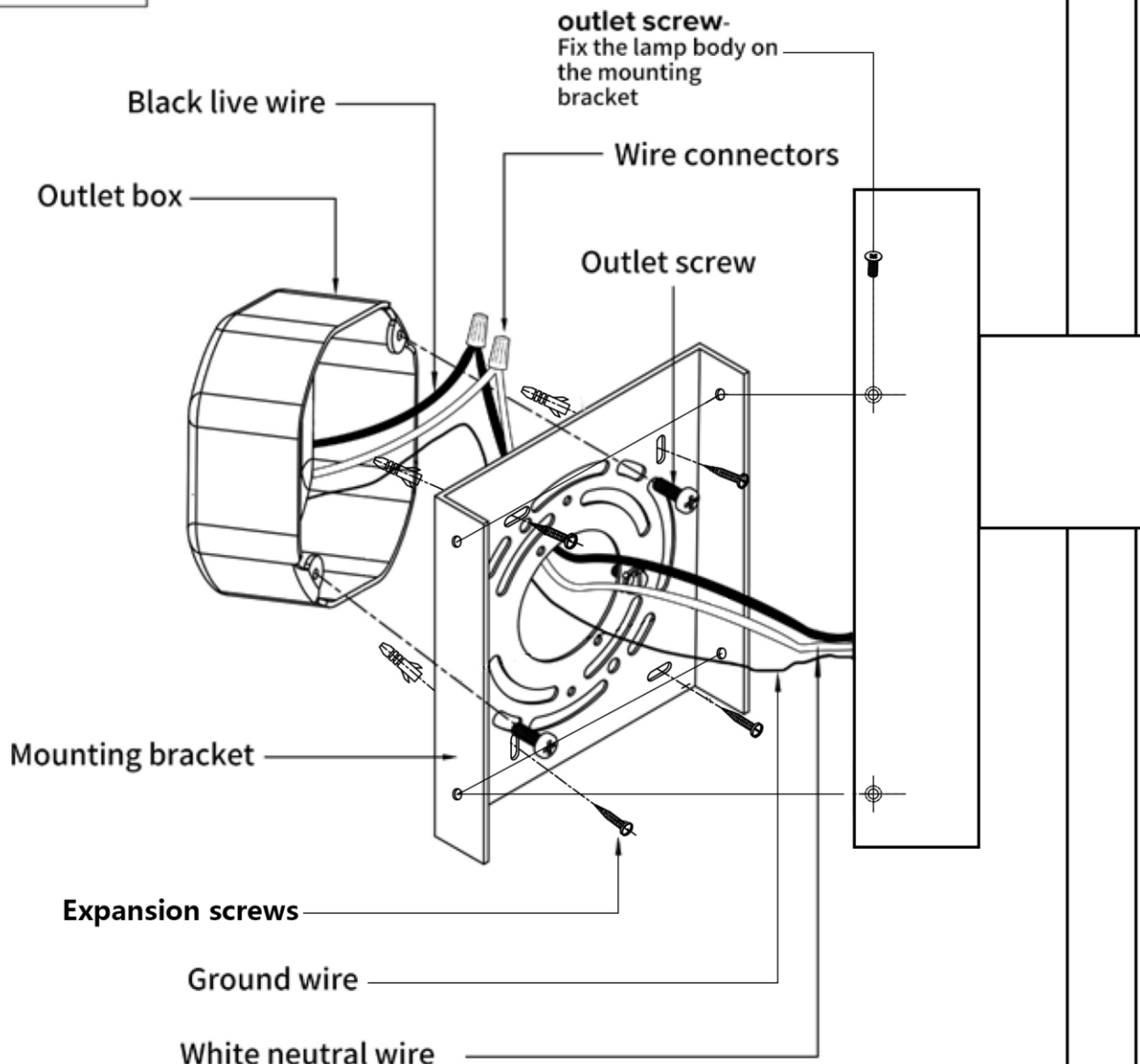

# Outdoor Wall Sconce User Manual

## SAFETY WARNING

- ⚡** Most electrical accidents are caused by ignorance and carelessness. With basic knowledge of electricity and caution, you can easily handle basic electrical installation and repairs. Here are some basic guidelines for your electrical installation:
- Before working, go to the main panel to turn off the switch or remove the fuse. Tape a sign to the main panel to warn people to keep away from the main panel when you are ready to work.
  - Before touching any wire, use a voltage tester to check if it's live. Make sure there is no electricity through wires. Check both outlets when you check for voltage in the receptacle. Because each of the outlets may be controlled by separate circuit.
  - Before you changing fuses, switch off the main power first. Make sure your body is dry and place one hand behind your back to avoid the electricity go completely through your chest.
  - Only use the insulated rim to touch a plug fuse. Use a fuse puller to remove cartridge fuses.
  - Use the insulated tools made of wood or fiberglass.
  - Make sure there are dry-chemical fire extinguishers in the kitchen, basement and workshop.
  - Enable grounding devices. Make sure all appliances and electrical systems are grounded.
  - Meet or exceed all the electrical working rules when you are doing electrical work.
  - Always make sure you are working with enough lights because it's easy to make mistakes if there is little light.
  - When you are not sure of the safety and electrical rules or tests. Please ask for a professional electrician for help.

## INSTALLATION

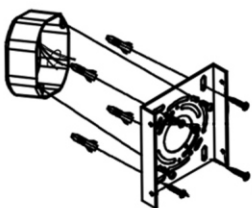

1. Attach the Mounting Bracket to the junction box using Outlet Screws

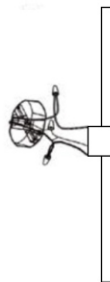

2. Connect fixture wires and junction box wires using the wire nuts

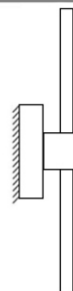

3. Attach the fixture to the Mounting Bracket through screw holes, and secure it with outer screws.