

Pure & Easy



# **ASSEMBLY INSTRUCTIONS**



# NOTICE

IMPORTANT, RETAIN FOR FUTURE REFERENCE: READ CAREFULLY  
WICHTIG, FÜR SPÄTERE NACHSCHLAGE AUFBEWAHREN: SORGFÄLTIG LESEN  
IMPORTANTE, GUARDAR PARA REFERENCIA FUTURA: LEER ATENTAMENTE  
IMPORTANTE, CONSERVARE PER RIFERIMENTI FUTURI: LEGGERE ATTENTAMENTE  
IMPORTANT, À CONSERVER POUR RÉFÉRENCE FUTURE : LIRE ATTENTIVEMENT

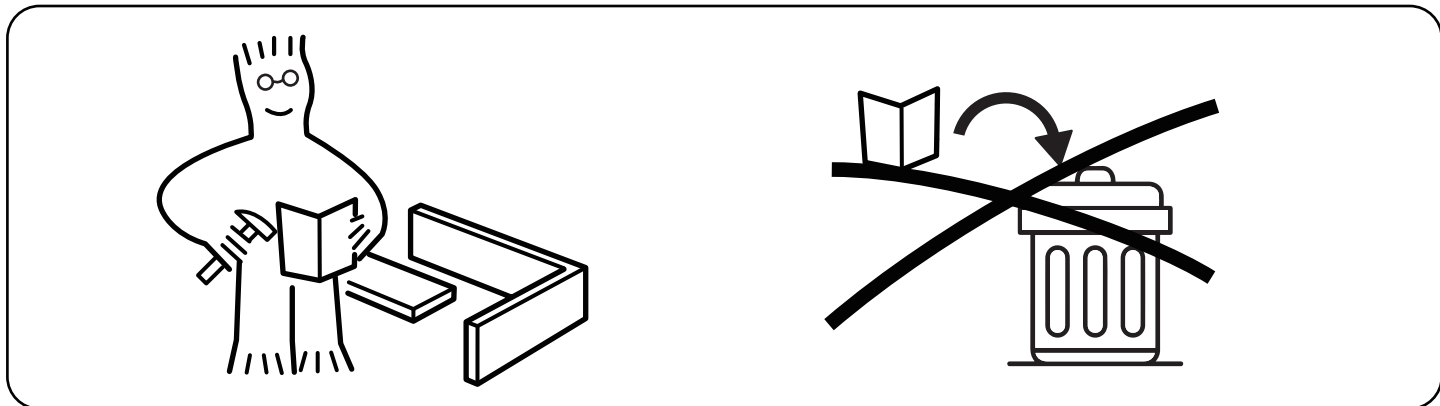

Assemble on a flat and solid surface. To avoid the unstable surface affecting the overall frame stability during installation.

Montieren Sie auf einer ebenen und festen Oberfläche. Um zu verhindern, dass eine unebene Oberfläche während der Montage die Gesamtrahmen-Stabilität beeinträchtigt.

Ensamblar en una superficie plana y sólida. Afin d'éviter que la surface inégale n'affecte la stabilité générale du cadre lors de l'installation.

Assemblare su una superficie piana e solida. Per evitare che una superficie irregolare influisca sulla stabilità complessiva della struttura durante l'installazione.

Assemble sur une surface plate et solide. Para evitar que la instalación en una superficie irregular afecte la estabilidad general del marco.

Professional installation is highly recommended.  
Eine professionelle Installation wird dringend empfohlen.  
Une installation professionnelle est fortement recommandée.  
Si raccomanda vivamente l'installazione professionale.  
Se recomienda altamente la instalación profesional.



Periodically Check That All Components Are Tightly Secured.  
Überprüfen Sie Regelmäßig, Dass Alle Komponenten Fest Gesichert Sind.  
Vérifiez Périodiquement Que Tous Les Composants Sont Bien Fixés.  
Controllare Periodicamente Che Tutti I Componenti Siano Ben Fissati.  
Verifique Periódicamente Que Todos Los Componentes Estén Bien Asegurados.

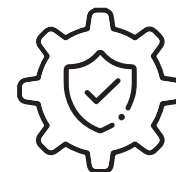



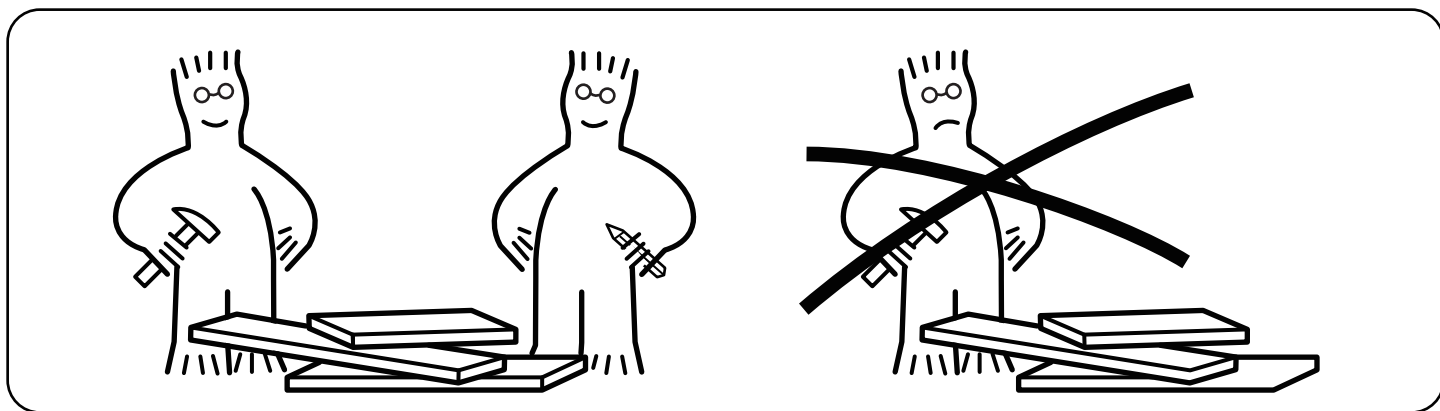



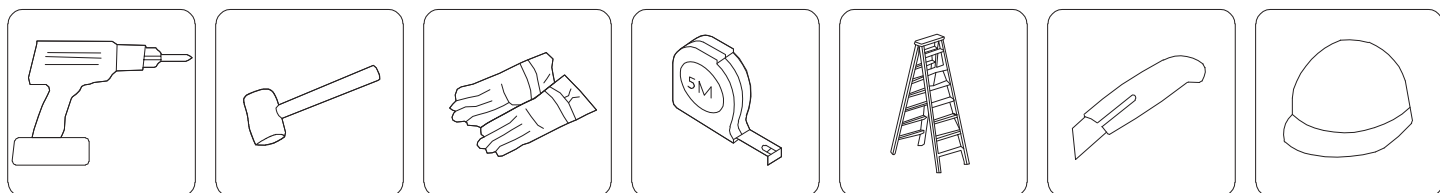



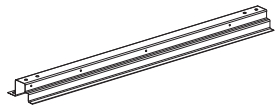
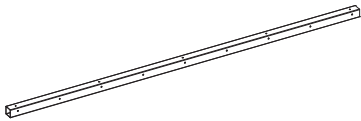

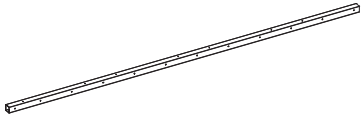
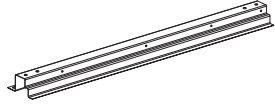
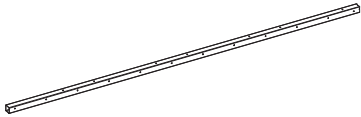
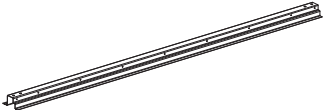
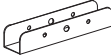
It is recommended that multiple people assemble this product.  
Es wird empfohlen, dass mehrere Personen dieses Produkt zusammenbauen.  
Il est recommandé que plusieurs personnes assemblent ce produit.  
Si raccomanda che più persone assemblino questo prodotto.  
Se recomienda que varias personas ensamblen este producto.



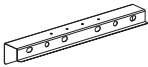
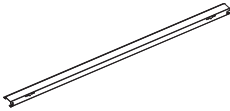

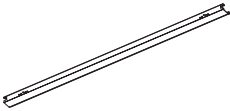
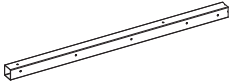
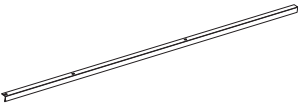

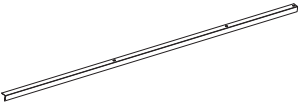
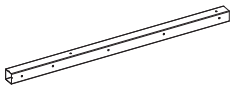





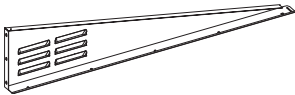

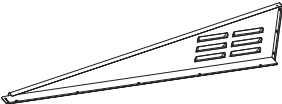

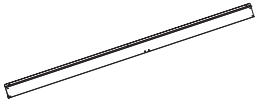
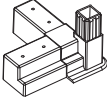
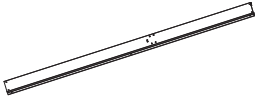

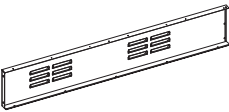

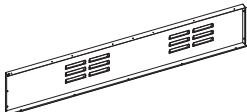

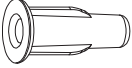

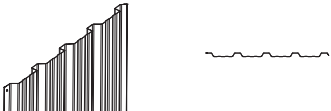
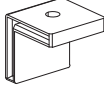

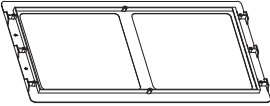
Please have the following auxiliary tools ready:

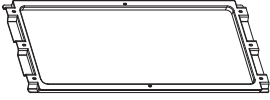

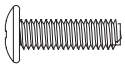
# PARTS

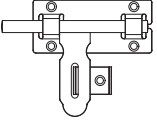
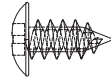
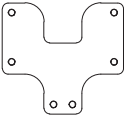
Item no.	Reference Image	Qty.	Item no.	Reference Image	Qty.
1L		X1	7		X2
1		X1	8L		X1
1R		X 1	8R		X1
2		X2	10		X3
3L		X1	15		X4
3R		X1	16		X2
4B		X3	17L		X1
5		X4	17R		X1
6L		X1	19L		X2
6		X1	19R		X2
6R		X1	20		X2

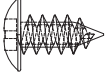
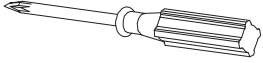
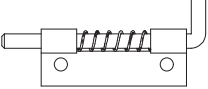
Item no.	Reference Image	Qty.	Item no.	Reference Image	Qty.
21		X4	C2		X1
21L		X1	W12		X8
21R		X1	M1		X2
22		X1	C		X4
23		X1	F		X4
24L		X1	F4		X4
24R		X1	F7		X68
W1		X4	F8		X52
W3		X4	F9		X2
W5		X6	F10		X2
W7		X4	F12		X1

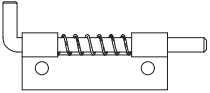
Item no.	Reference Image	Qty.	Item no.	Reference Image	Qty.
F13		X1	S6	 M4 X 8mm	X58
F14		X1	S6A		X10
S1		X1	S7	 M4	X62
S2		X1	S8	 M5 X 16mm	X6
S3		X1	S9		X4
S4	 M4 X 10mm	X264	S12		X1
S5L		X1	S15		X1
S5R		X1			

# EXPLODED VIEW

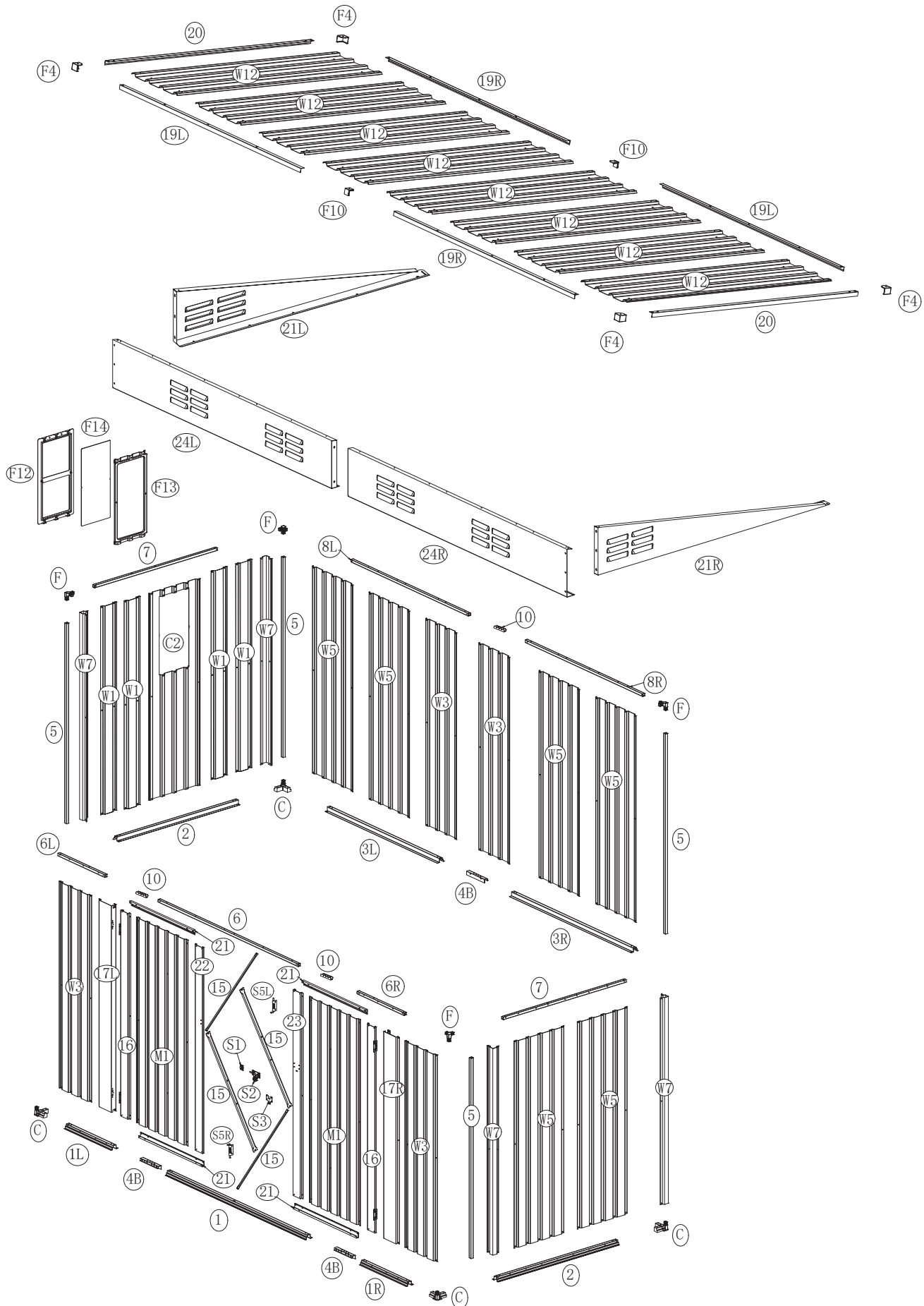



**2**

③L 1pc   ③R 1pc   ④B 1pc   ⑤S4 4pcs

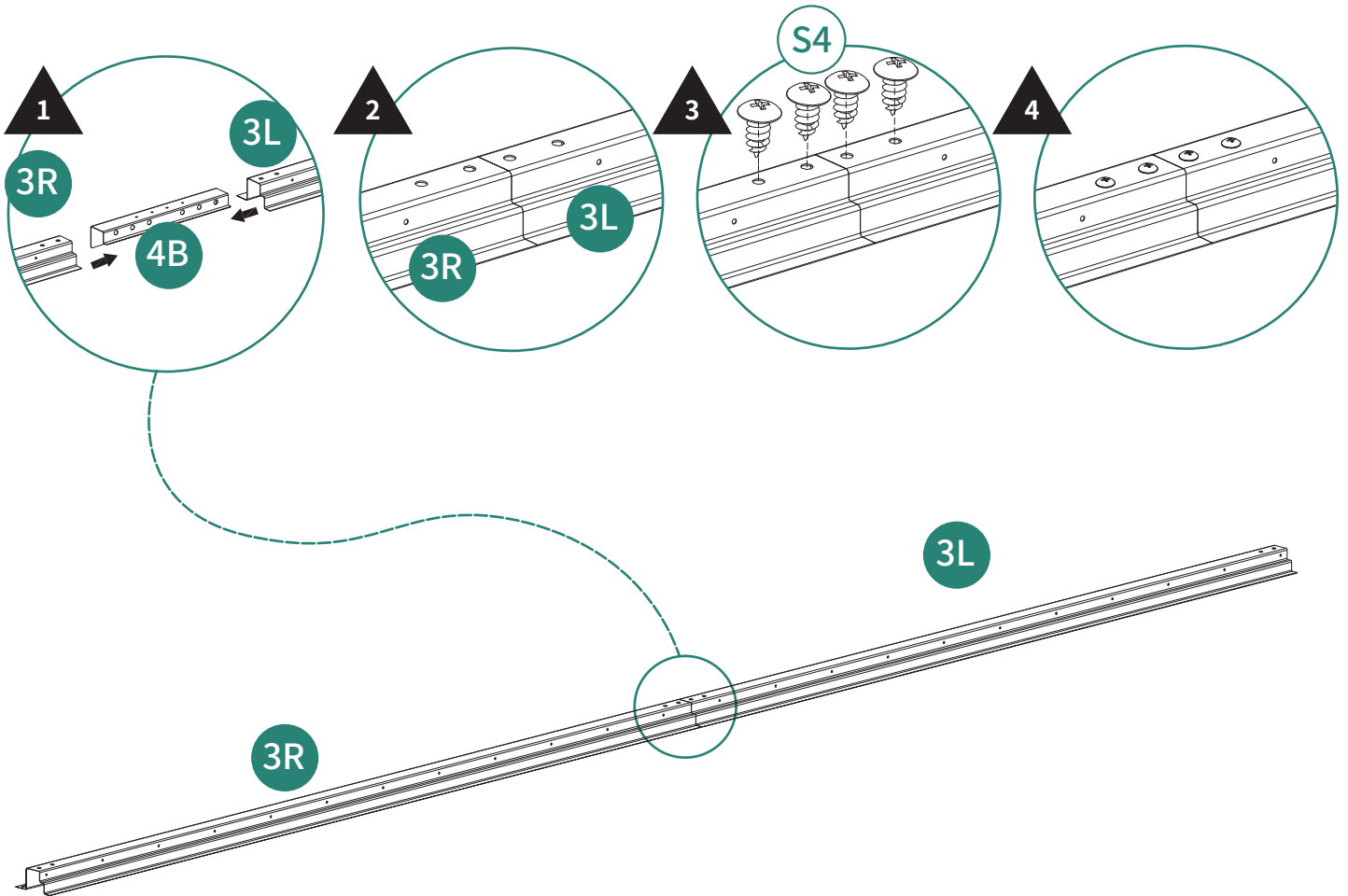

# 3



② 2pcs

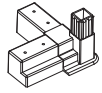

③ 4pcs



④ 16pcs

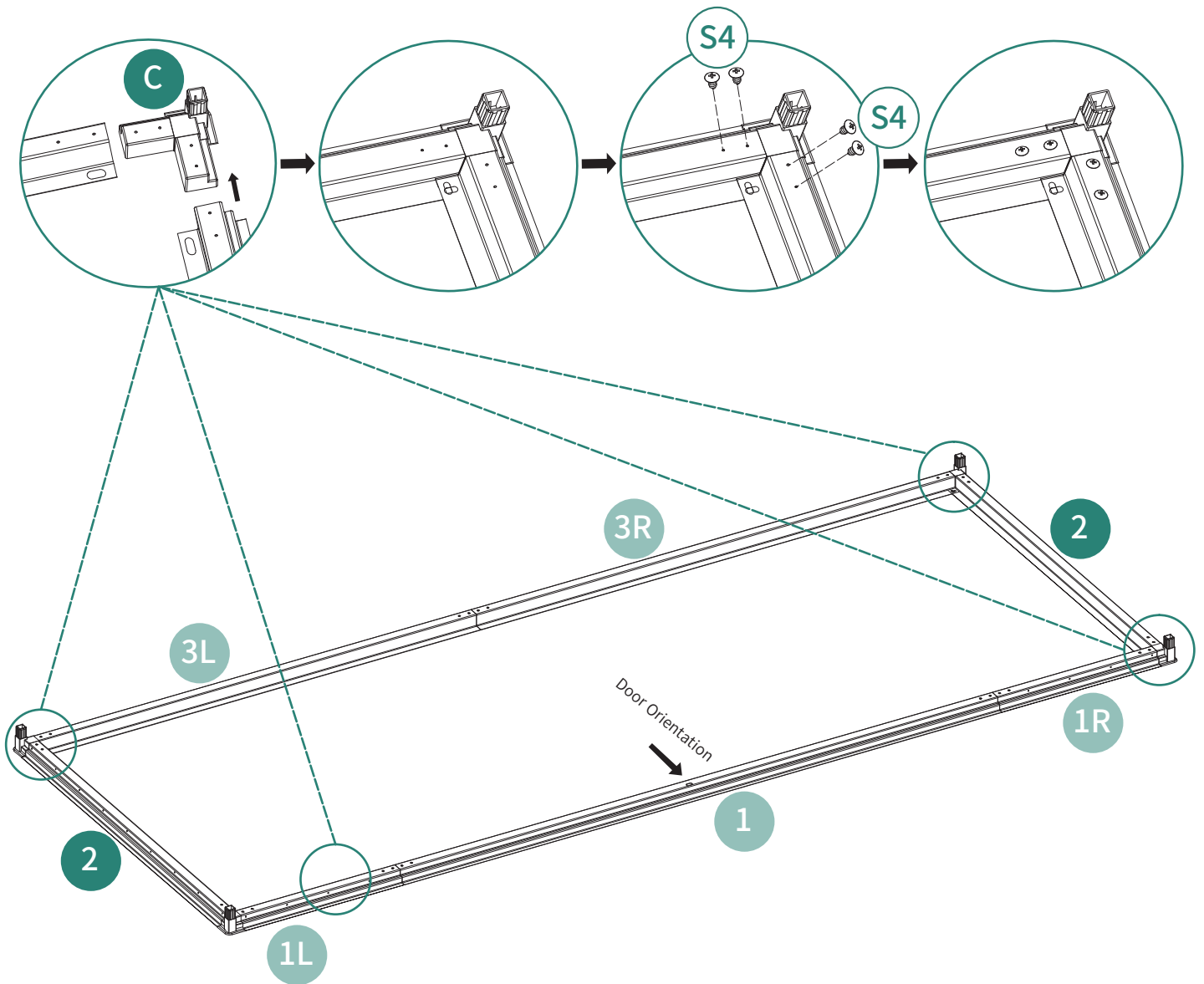

4



⑤ 4pcs

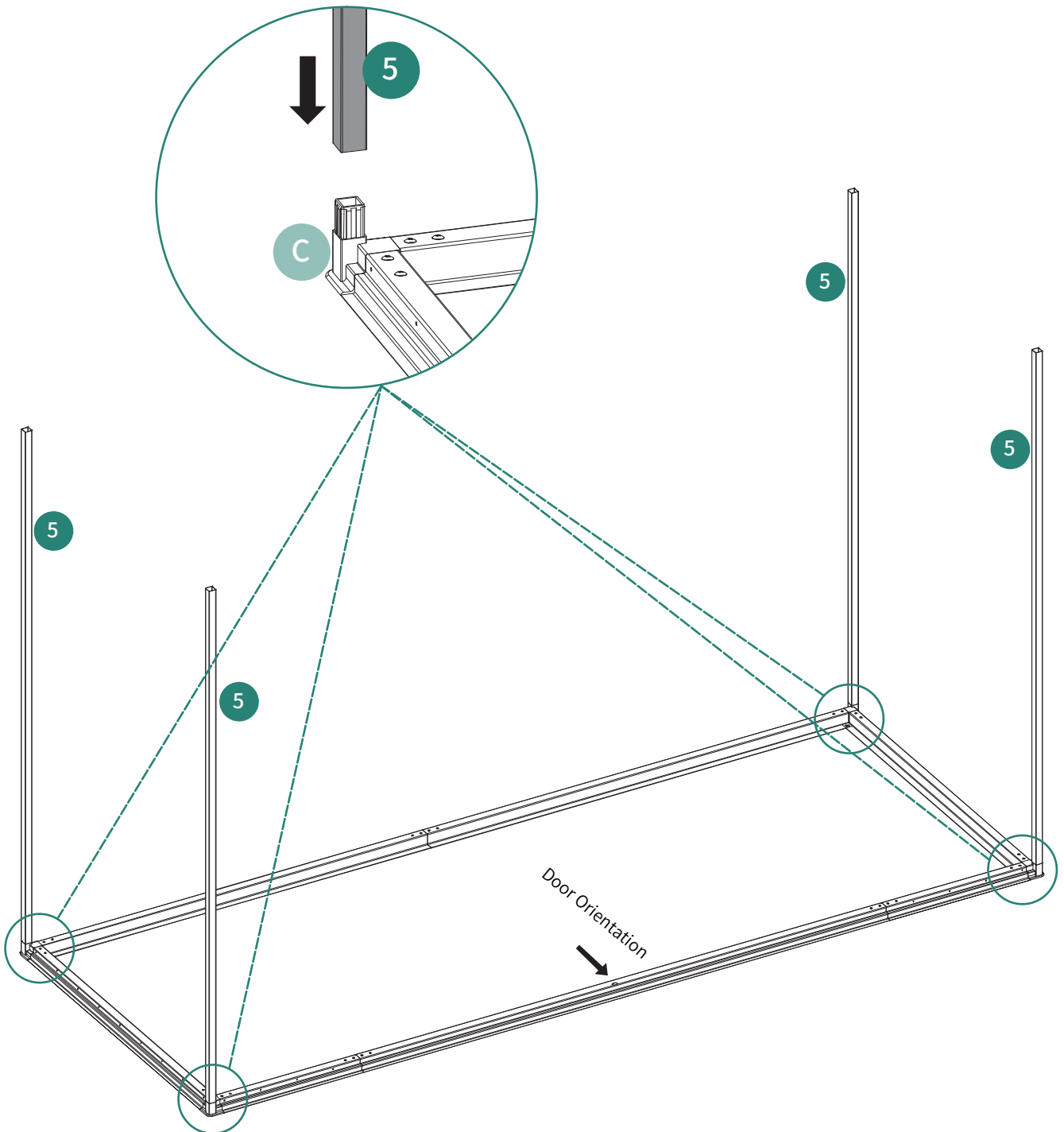

5

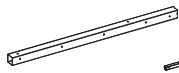

⑥L 1pc



⑥ 1pc

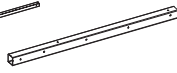

⑥R 1pc







⑩ 2pcs

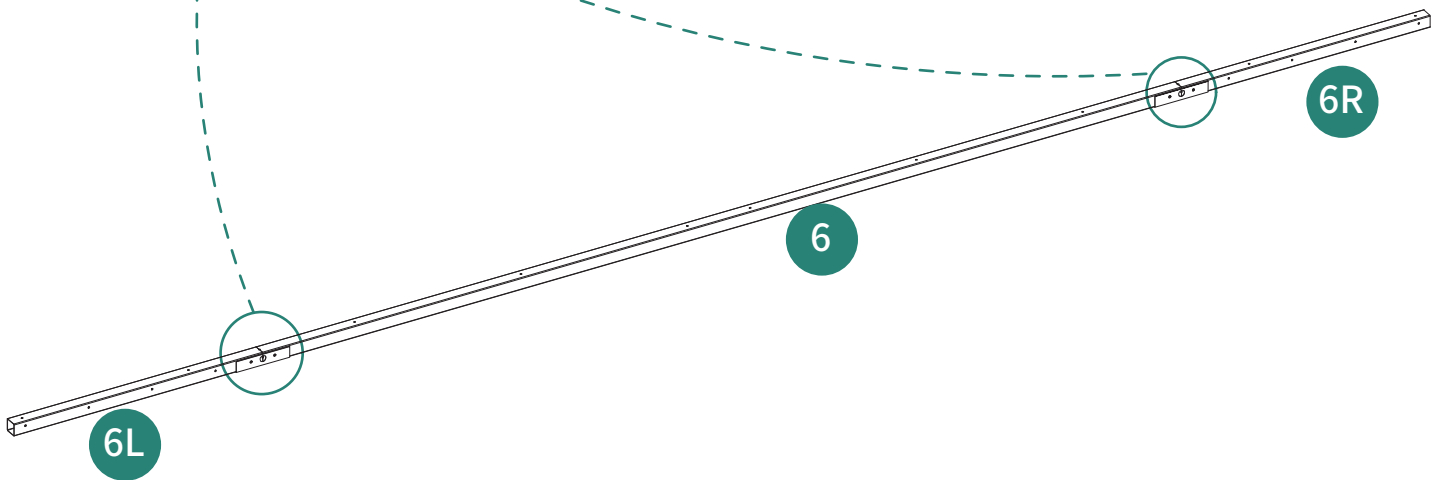
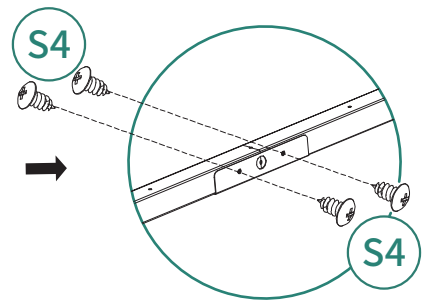
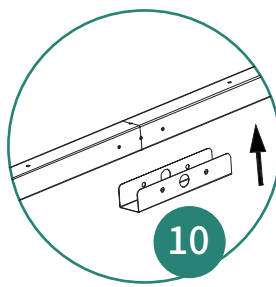
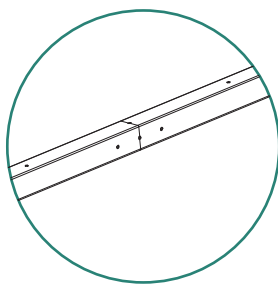
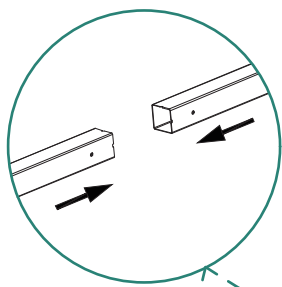

④S 8pcs

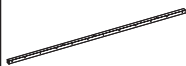

6

-  8L 1pc
-  8R 1pc
-  10 1pc
-  S4 4pcs

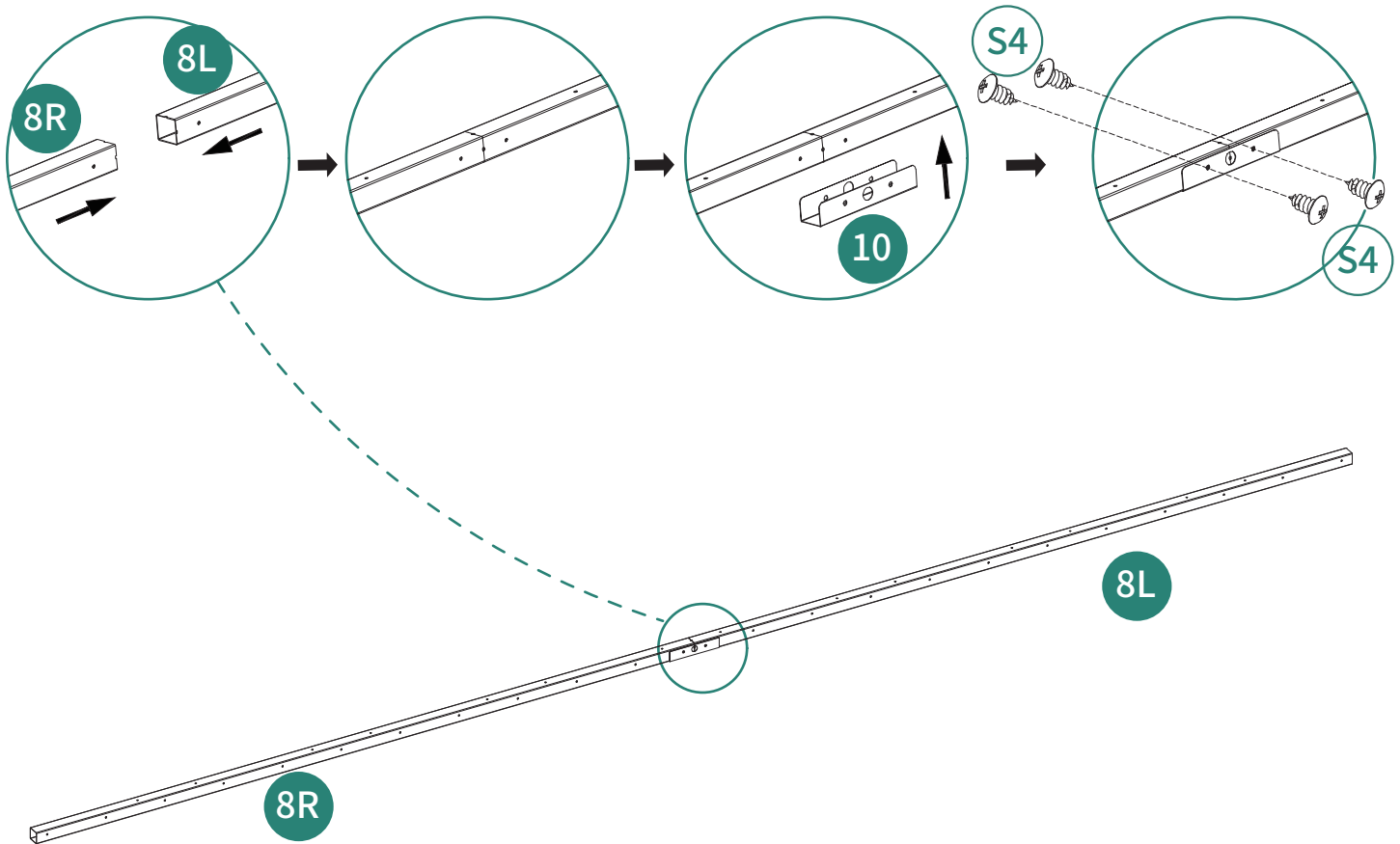

# 7



⑦ 2pcs

④ F 4pcs

④ S4 8pcs

**NOTES:**

When assembling the beam:

1. Make sure parts (8L, 8R) have the sides with closely spaced holes facing outward, and the sides with widely spaced holes facing upward.

2. Ensure parts (6L, 6R) have the sides with rectangular latch lock slot facing downward. Part 6L should be on the left side and part 6R on the right.

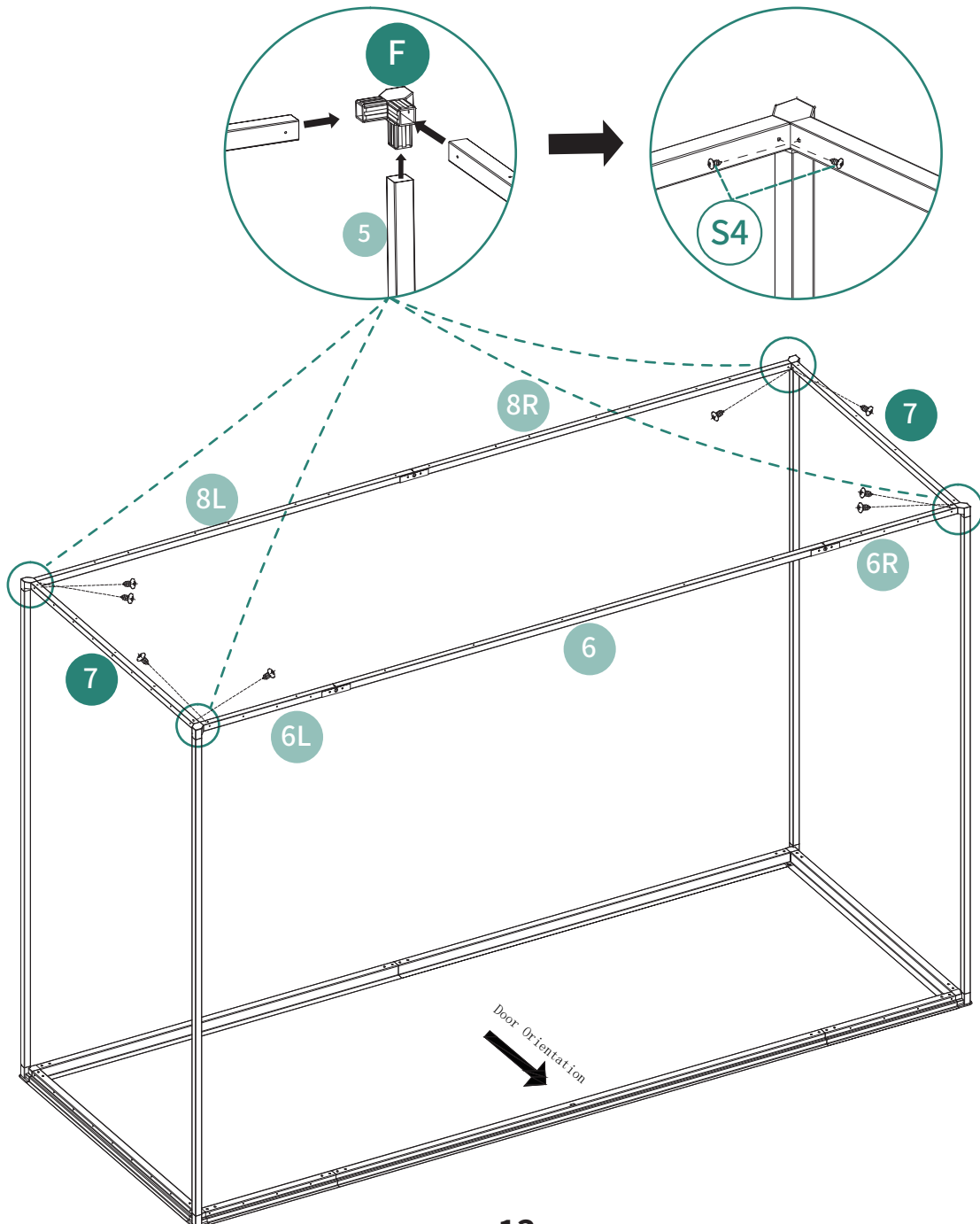

# 8



W1 4pcs



C2 1pc



W7 2pcs



S4 18pcs



S6 6pcs



S7 6pcs

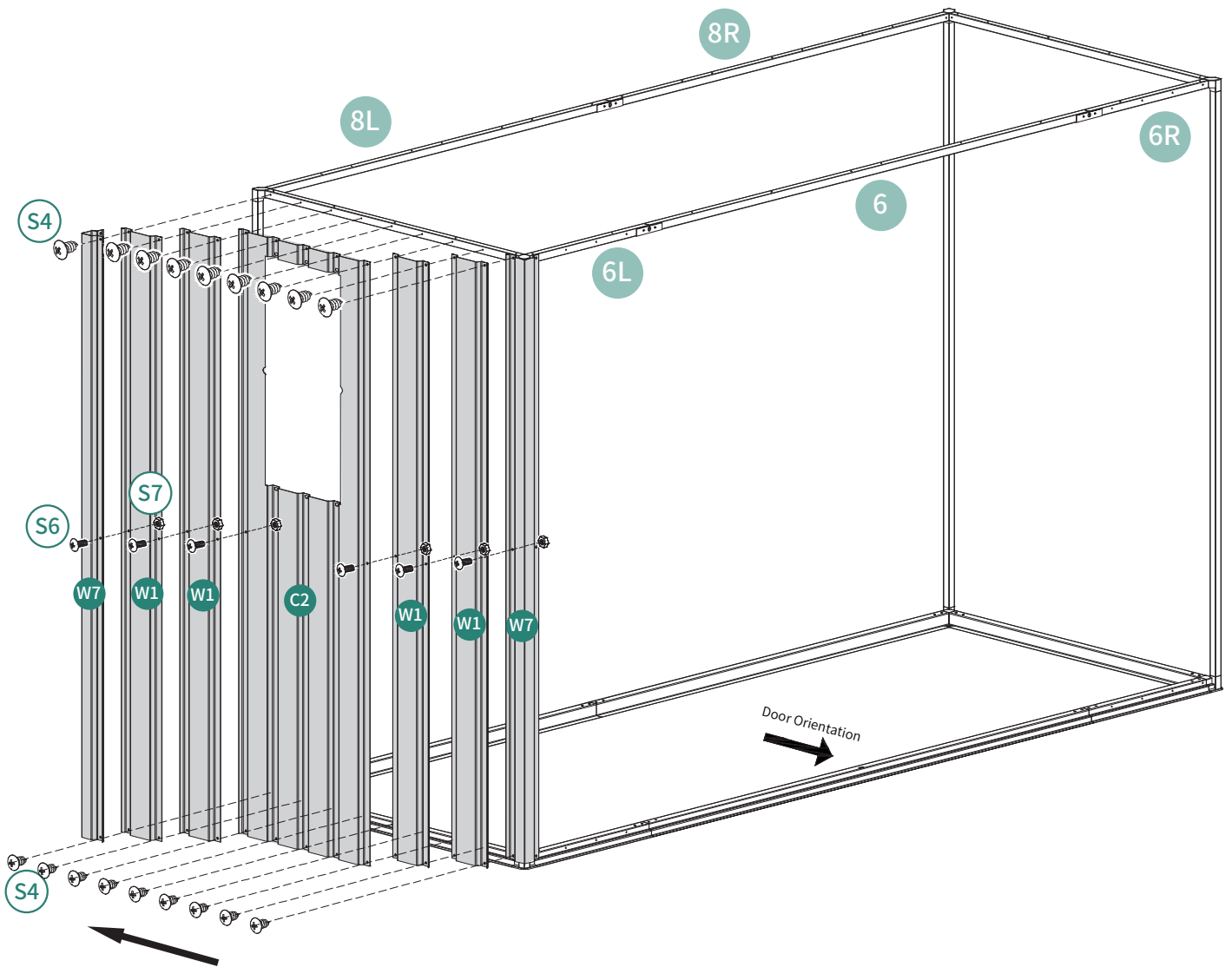

Secure the screws sequentially as indicated by the arrow.

# 9

-      
- ⓂW3 2pcs   ⓂW5 4pcs   ⓂW7 1pc   ⓂS4 46pcs   ⓂS6 7pcs   ⓂS7 7pcs

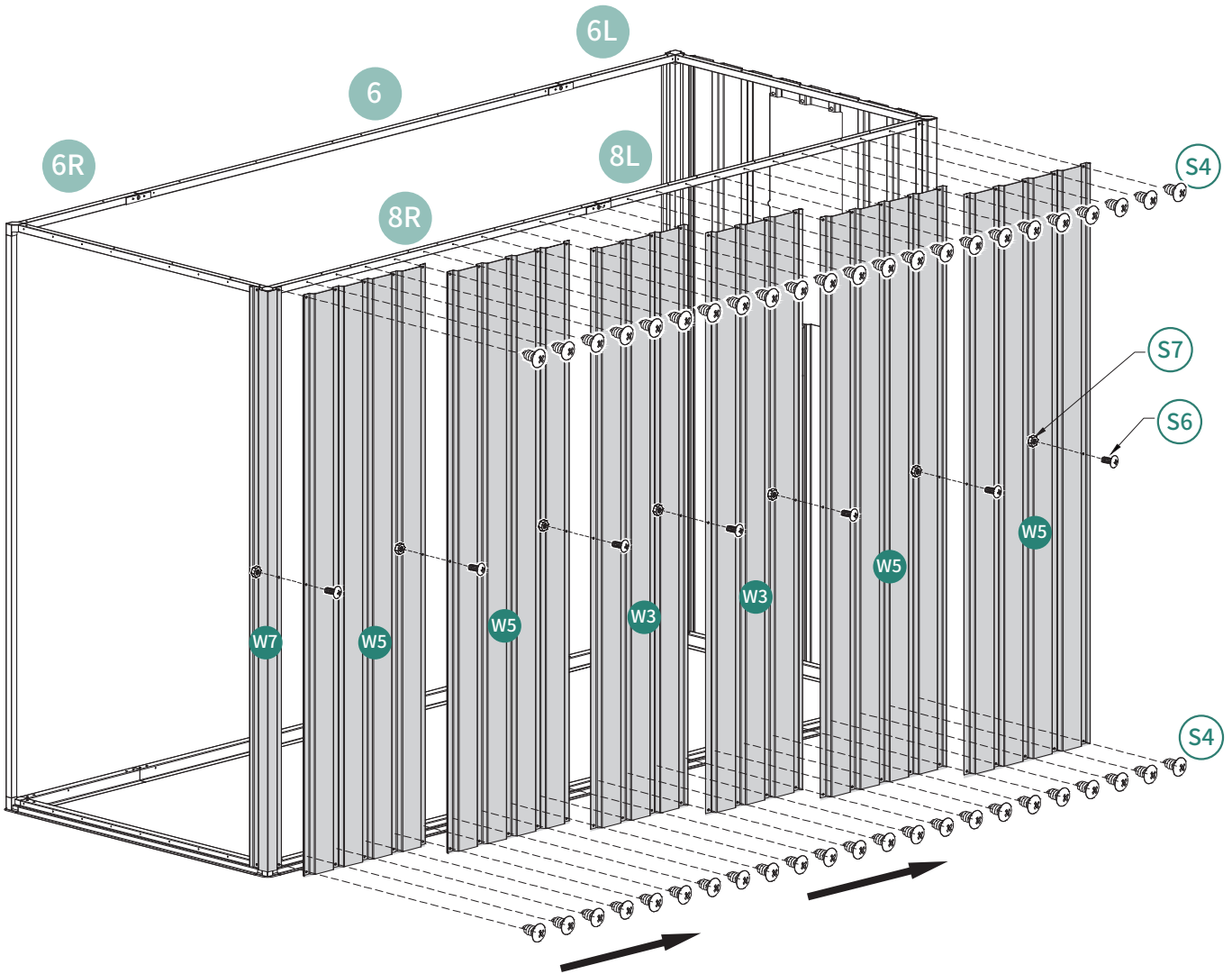

Secure the screws sequentially as indicated by the arrow.

# 10



W5 2pcs



W7 1pc



S4 18pcs



S6 3pcs



S7 3pcs

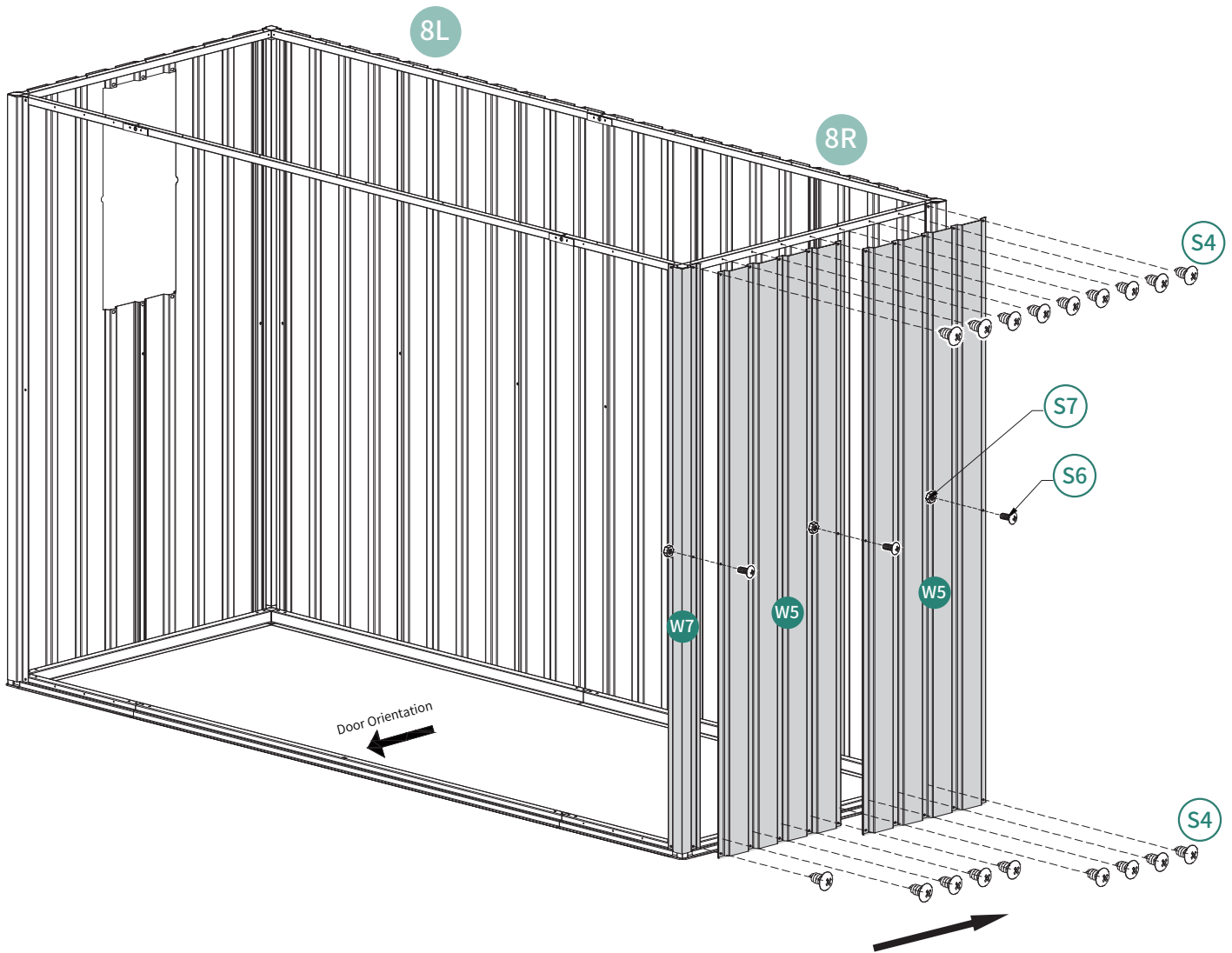

Secure the screws sequentially as indicated by the arrow.

# 11



W3 2pcs 17L 1pc 17R 1pc S4 20pcs S6 4pcs S7 4pcs

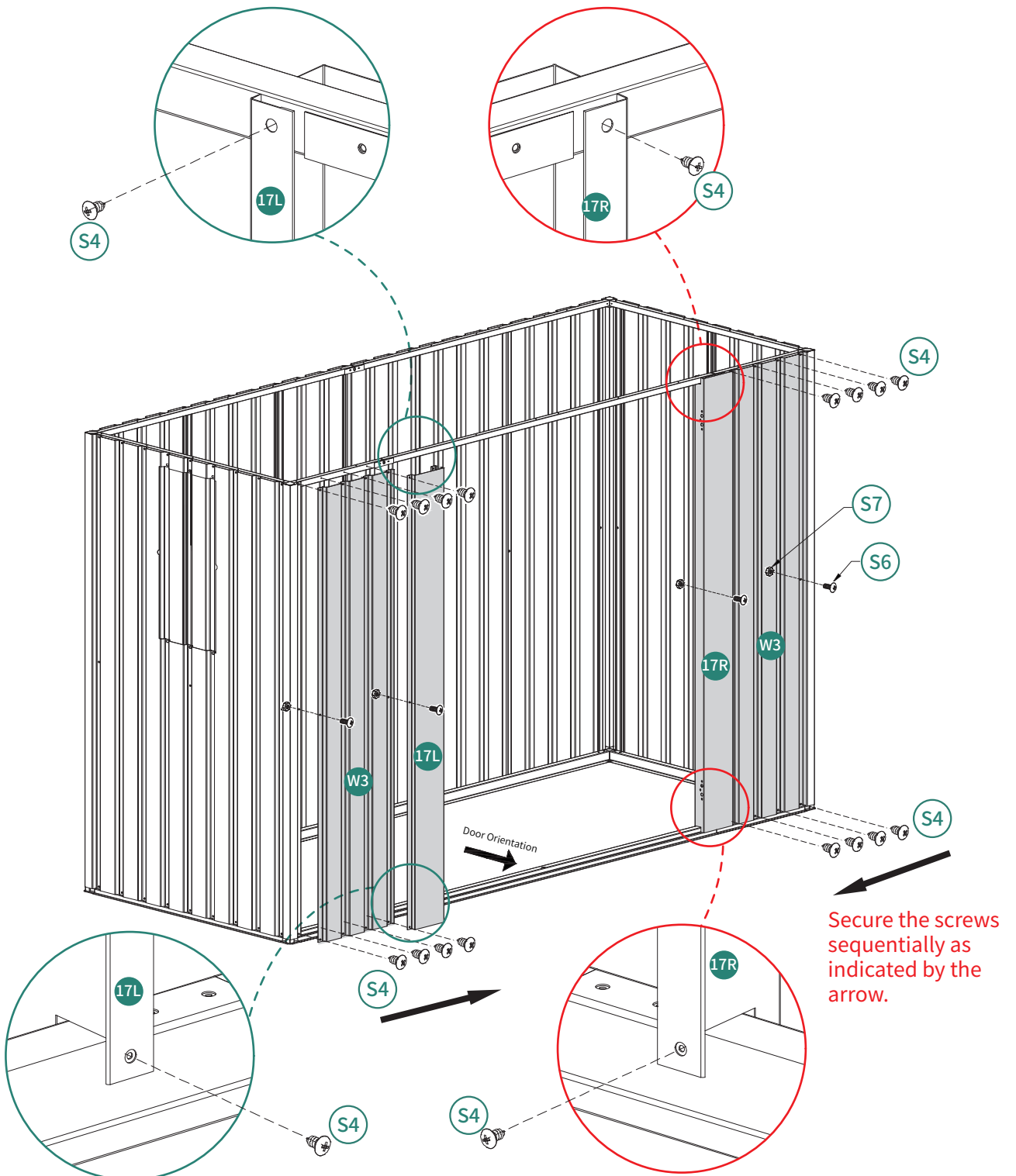

# 12

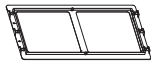

F12 1pc

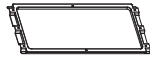

F13 1pc

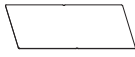

F14 1pc



S4 8pcs

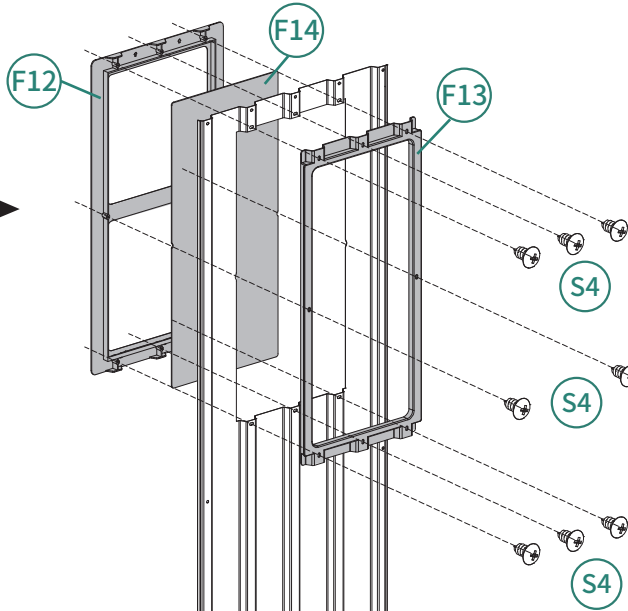
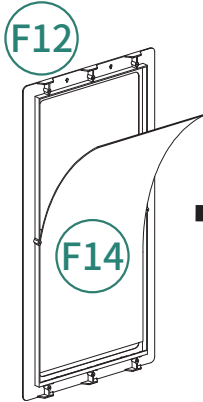

F13

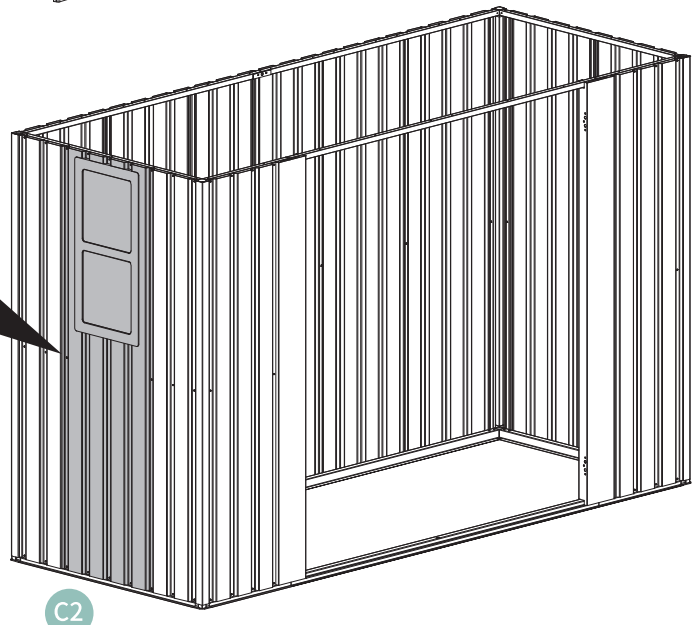
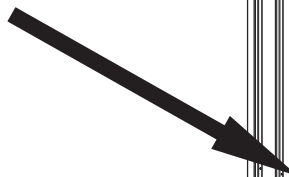
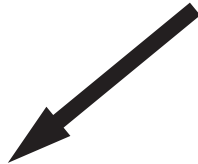
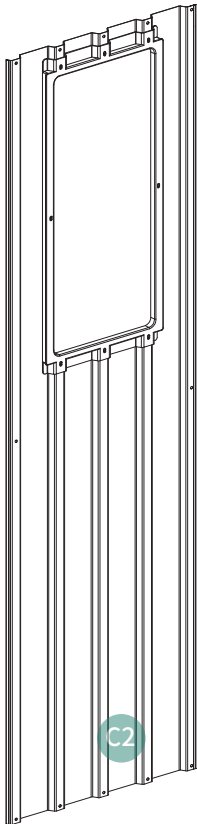

13

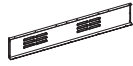

24L 1pc

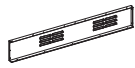

24R 1pc



S6 2pcs



S7 2pcs

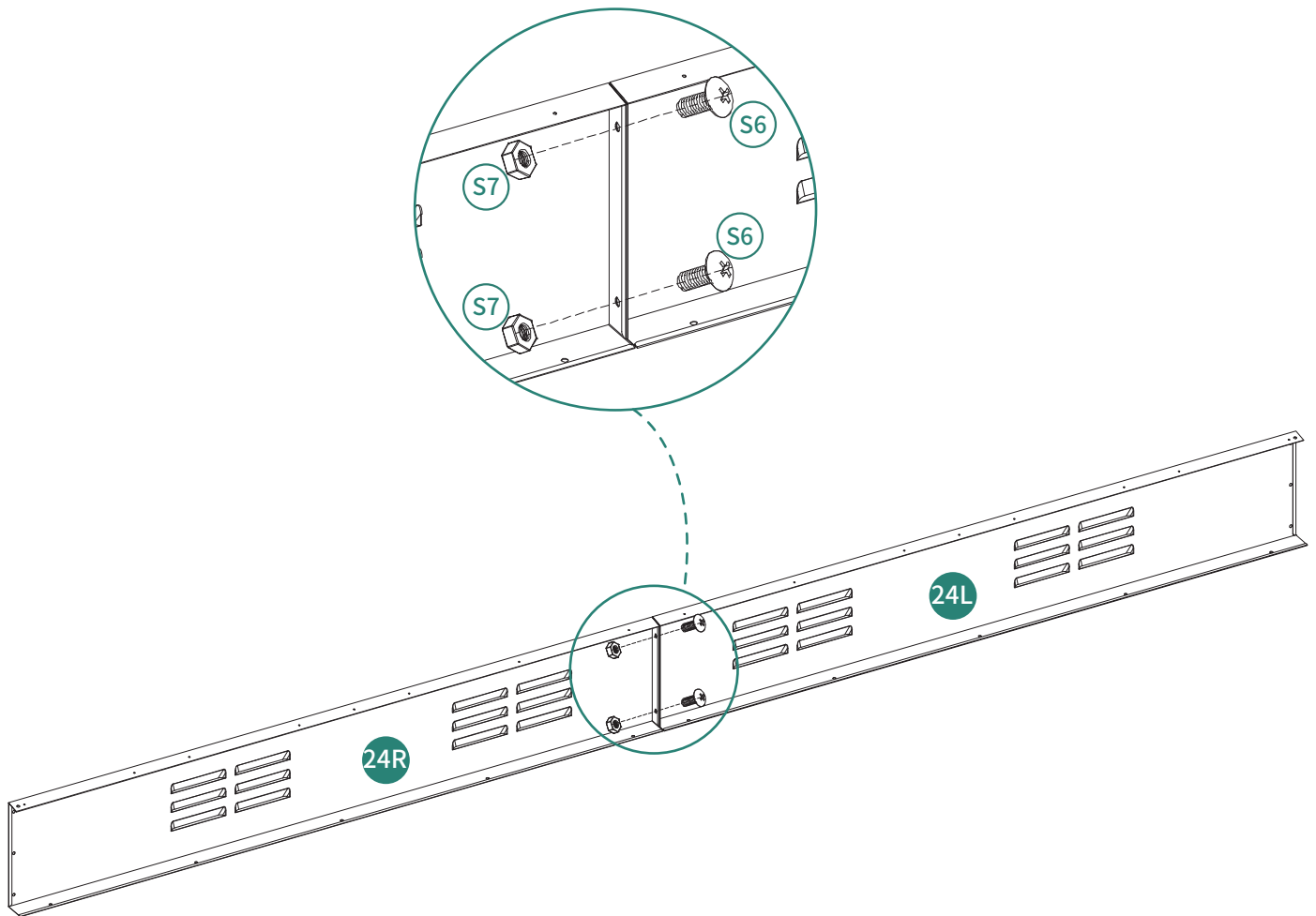

14



S4 10pcs

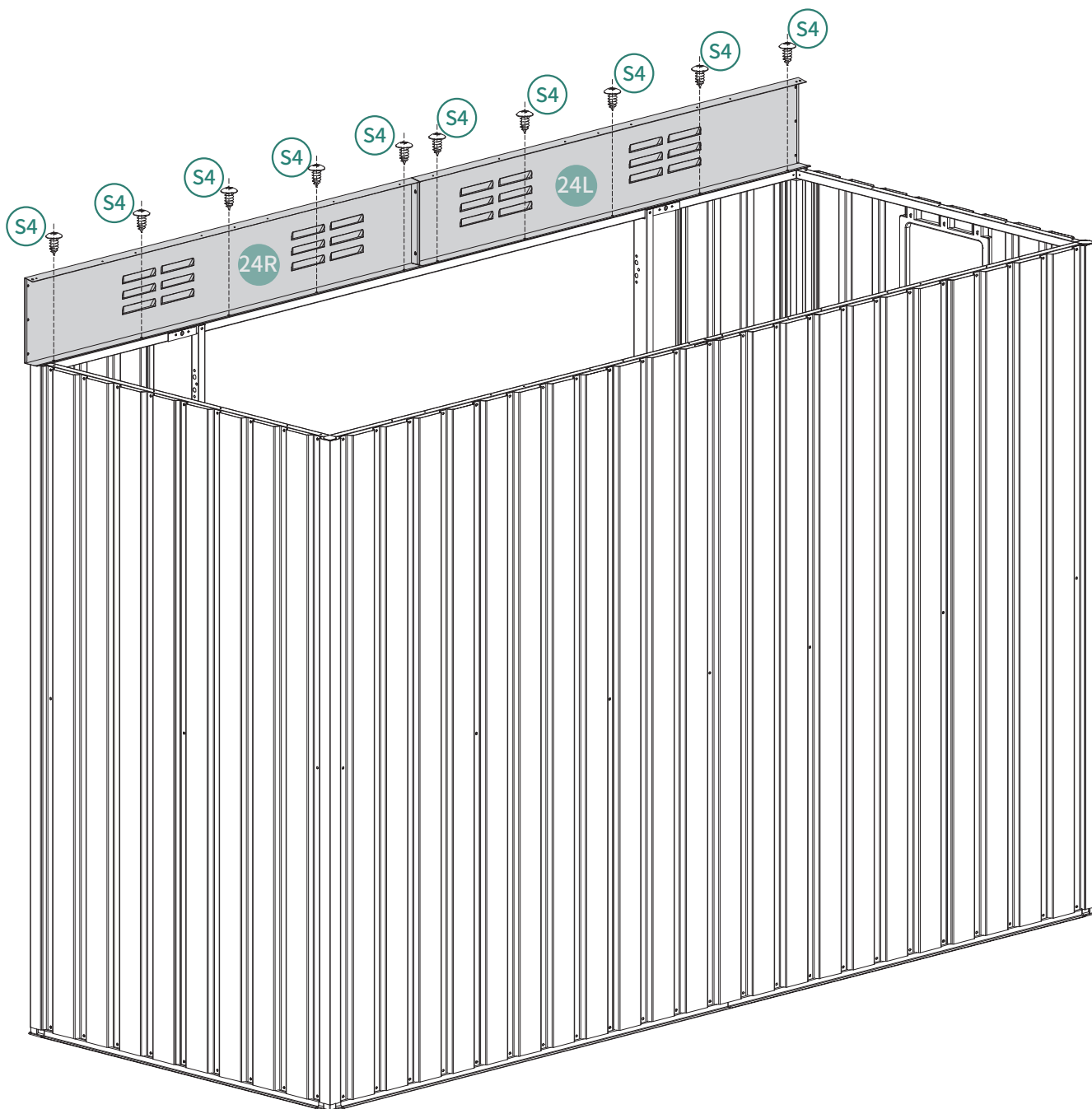

# 15

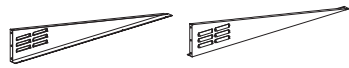

21L 1pc

21R 1pc



S4 12pcs



S6 6pcs



S7 6pcs

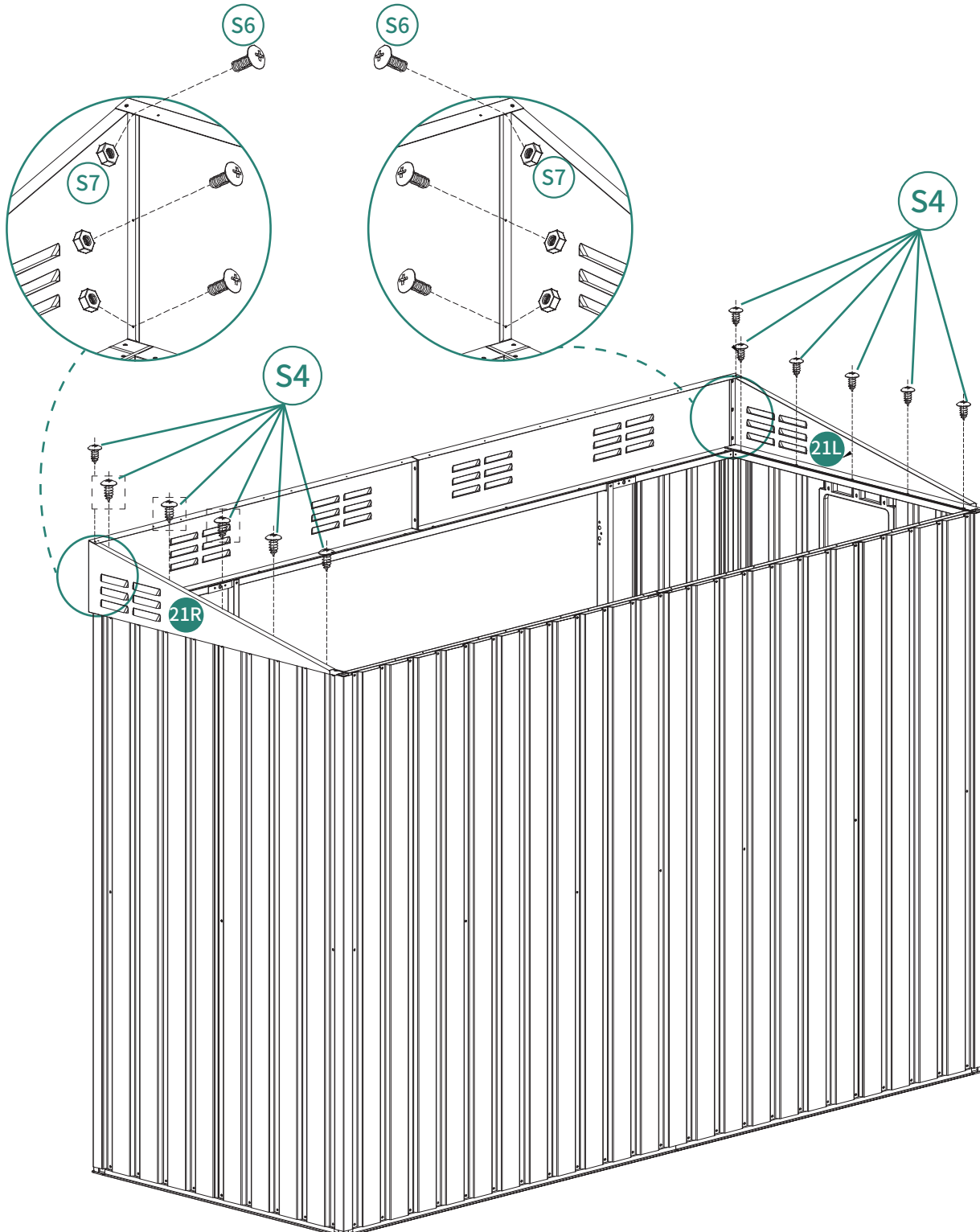

# 16

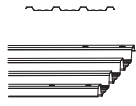

W12 8pcs



S4 46pcs



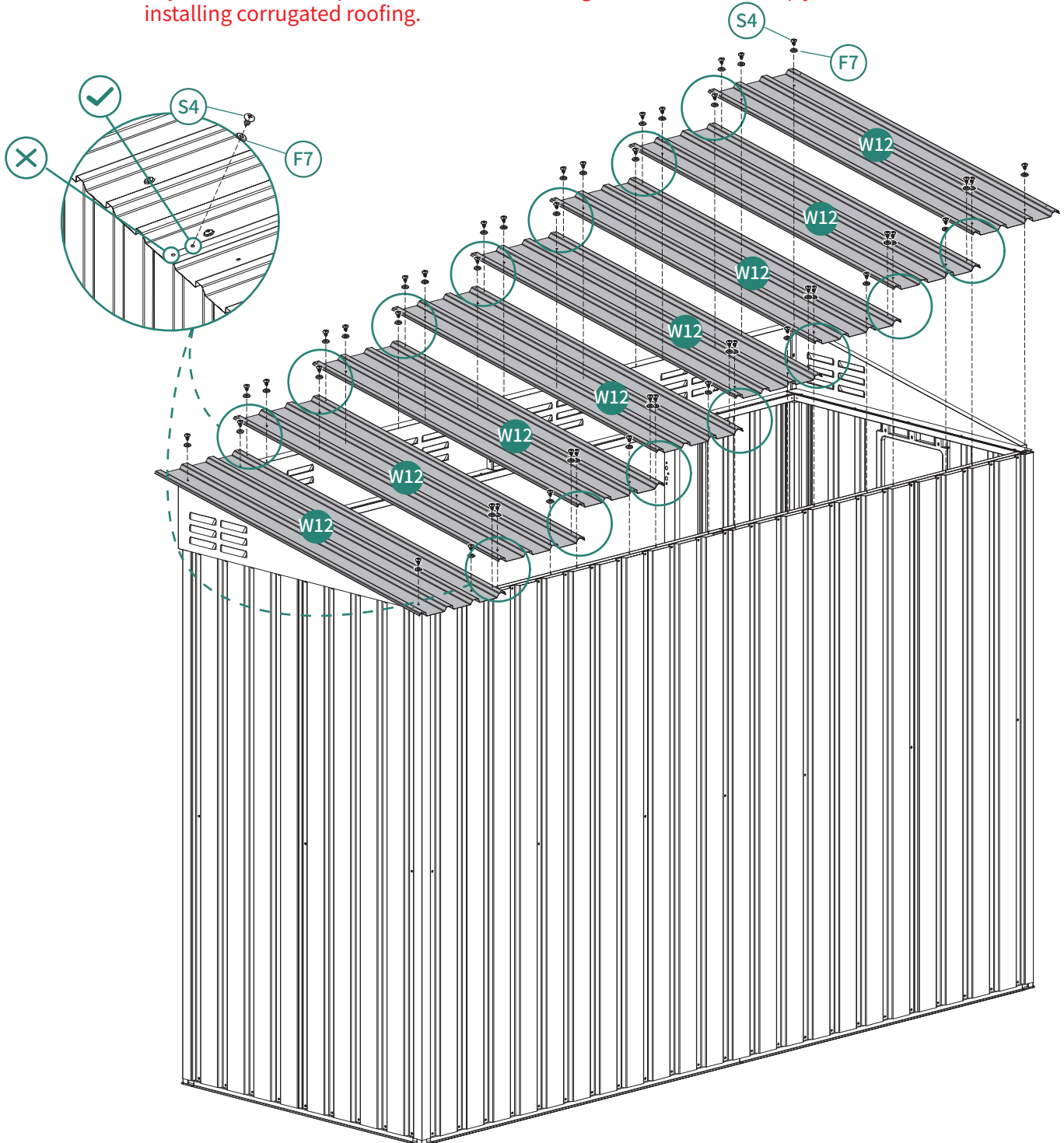

F7 46pcs

Pay attention to the placement of the fastening screws at the overlap joints when installing corrugated roofing.



**17**

		
②0 2pcs	③4 4pcs	④7 4pcs

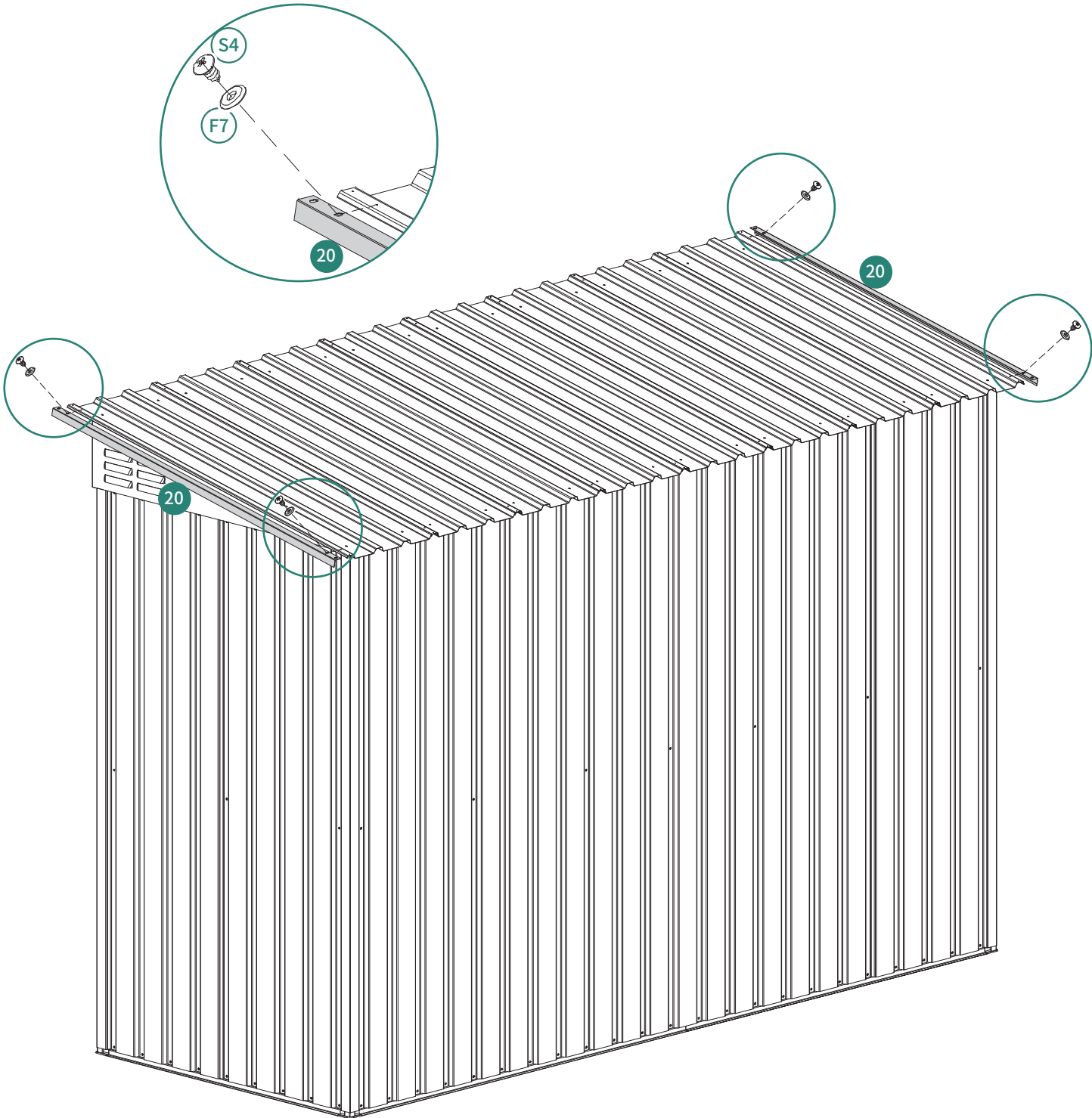

# 18

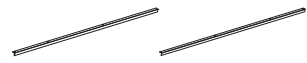

①9L 2pcs ①9R 2pcs ③S4 12pcs ③S8 6pcs ③F7 18pcs ③F4 4pcs ③F10 2pcs

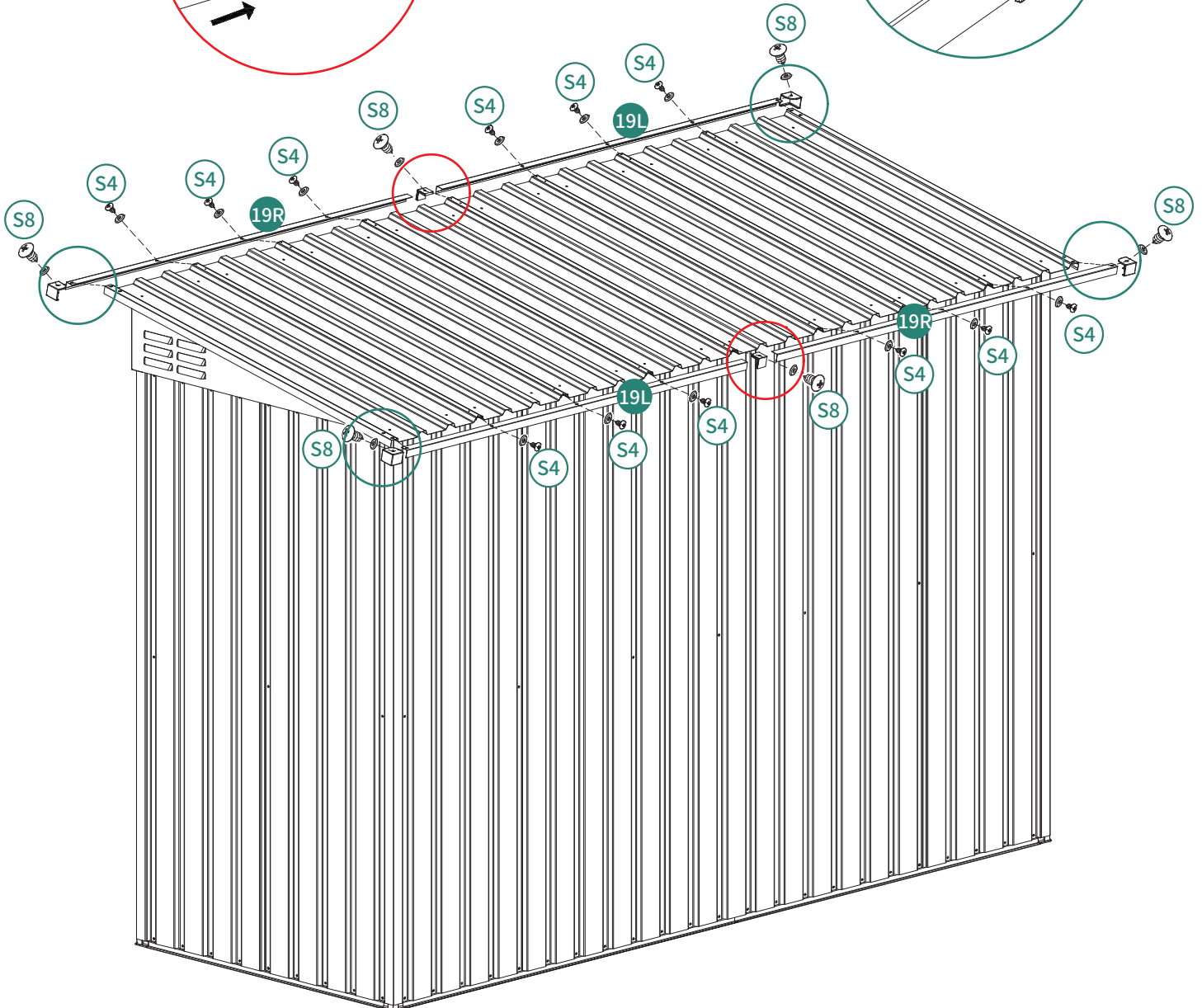
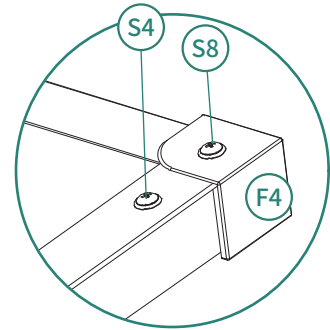
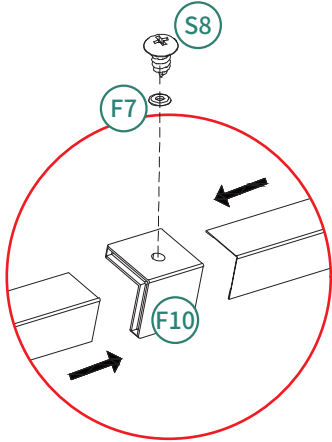

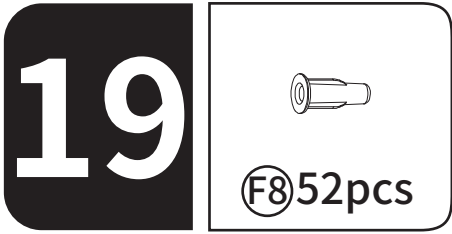

After fixing the screws, there will be some exposed screw parts on the component. Please use the provided plastic protective covers to protect the exposed screw parts, to avoid scratches during use.

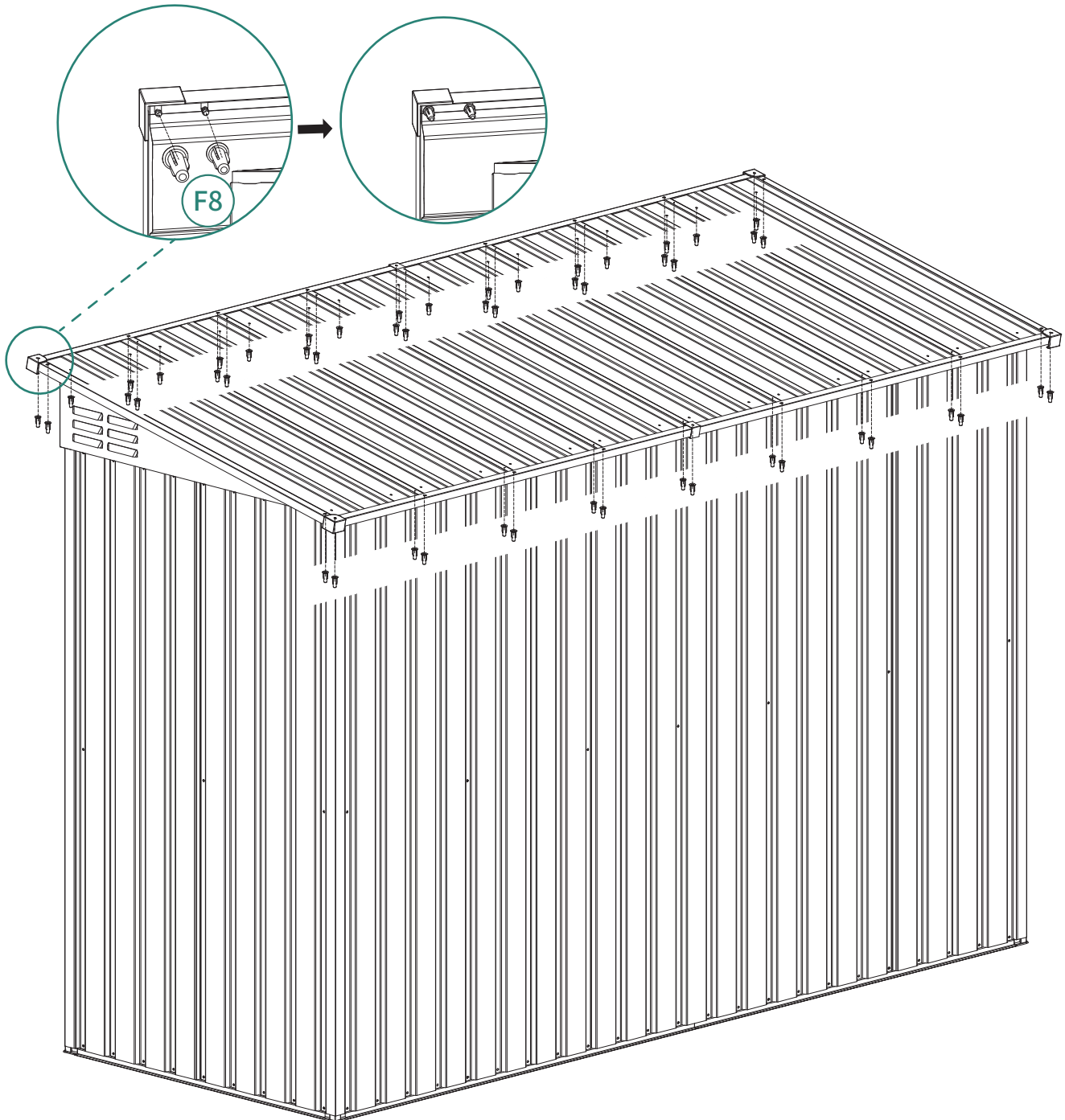

# 20

- 
- ⑮ 2 pcs
  - ⑯ 1 pc
  - ⑳ 1 pc
  - ㉑ 1 pc
  - ㉒ 3 pcs
  - ㉓ 6 pcs
  - ㉔ 3 pcs
  - ㉕ 1 pc

Install part 16 to the side of part M1 (front side panel) with the longer distance from the center screw hole to the edge, and part 22 to the side with the shorter distance.

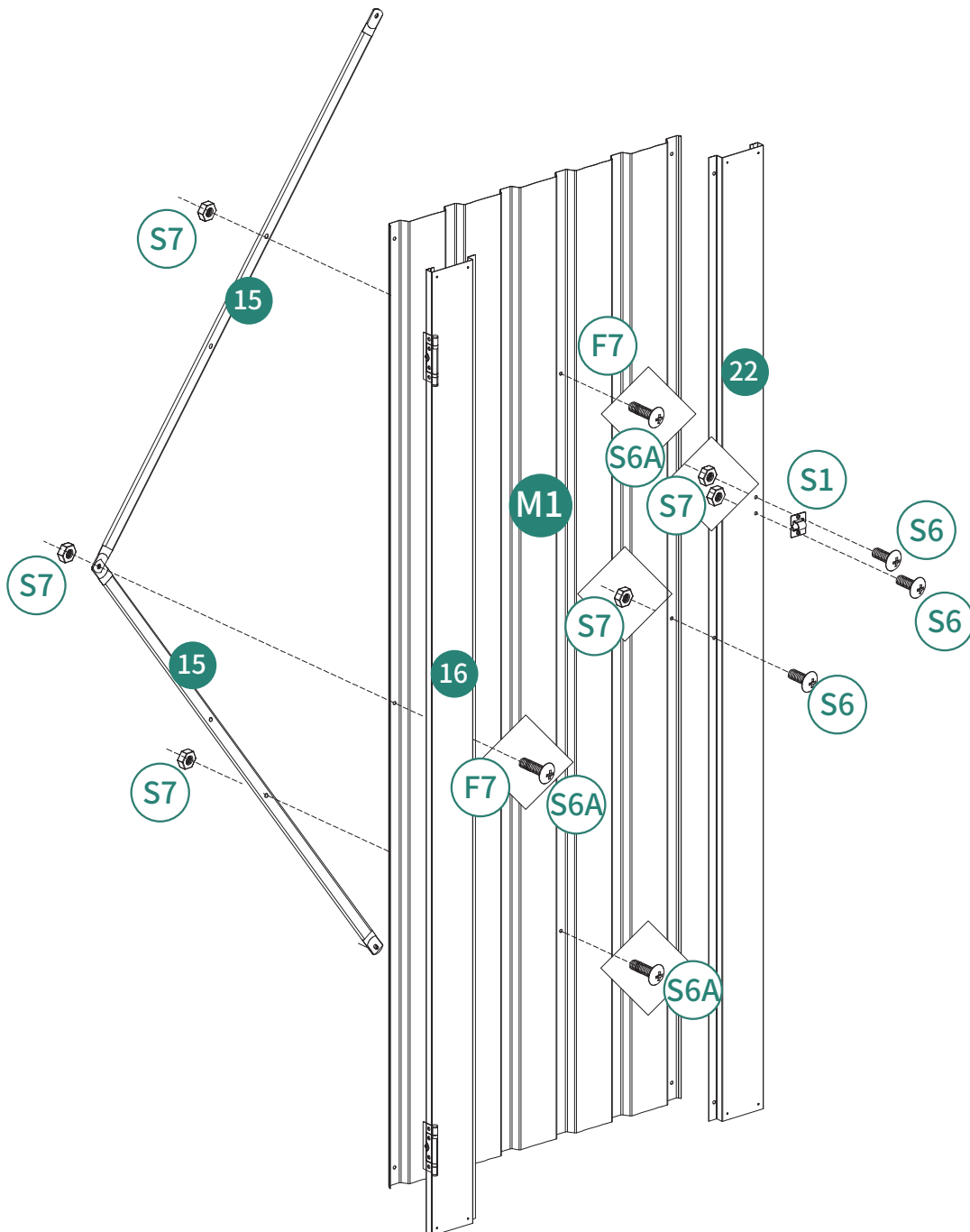

**21**



②1 2pcs    ④S4 8pcs

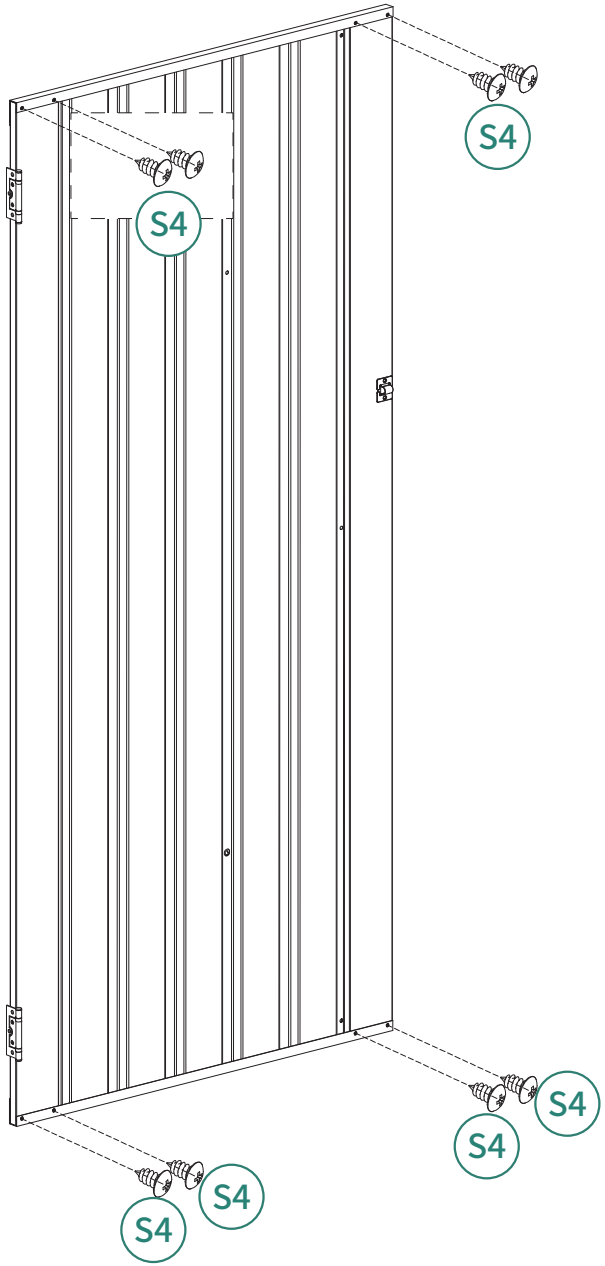
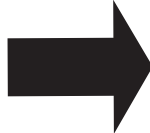
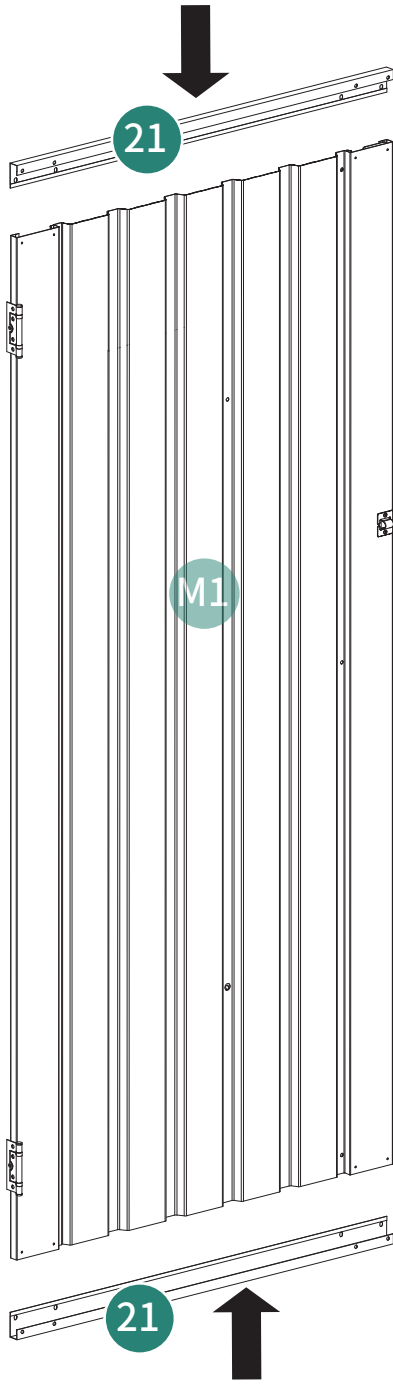

# 22

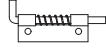
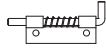

(S4) 2pcs

(S5L) 1pc

(S5R) 1pc

(S6) 6pcs

(S6A) 2pcs

(S7) 8pcs

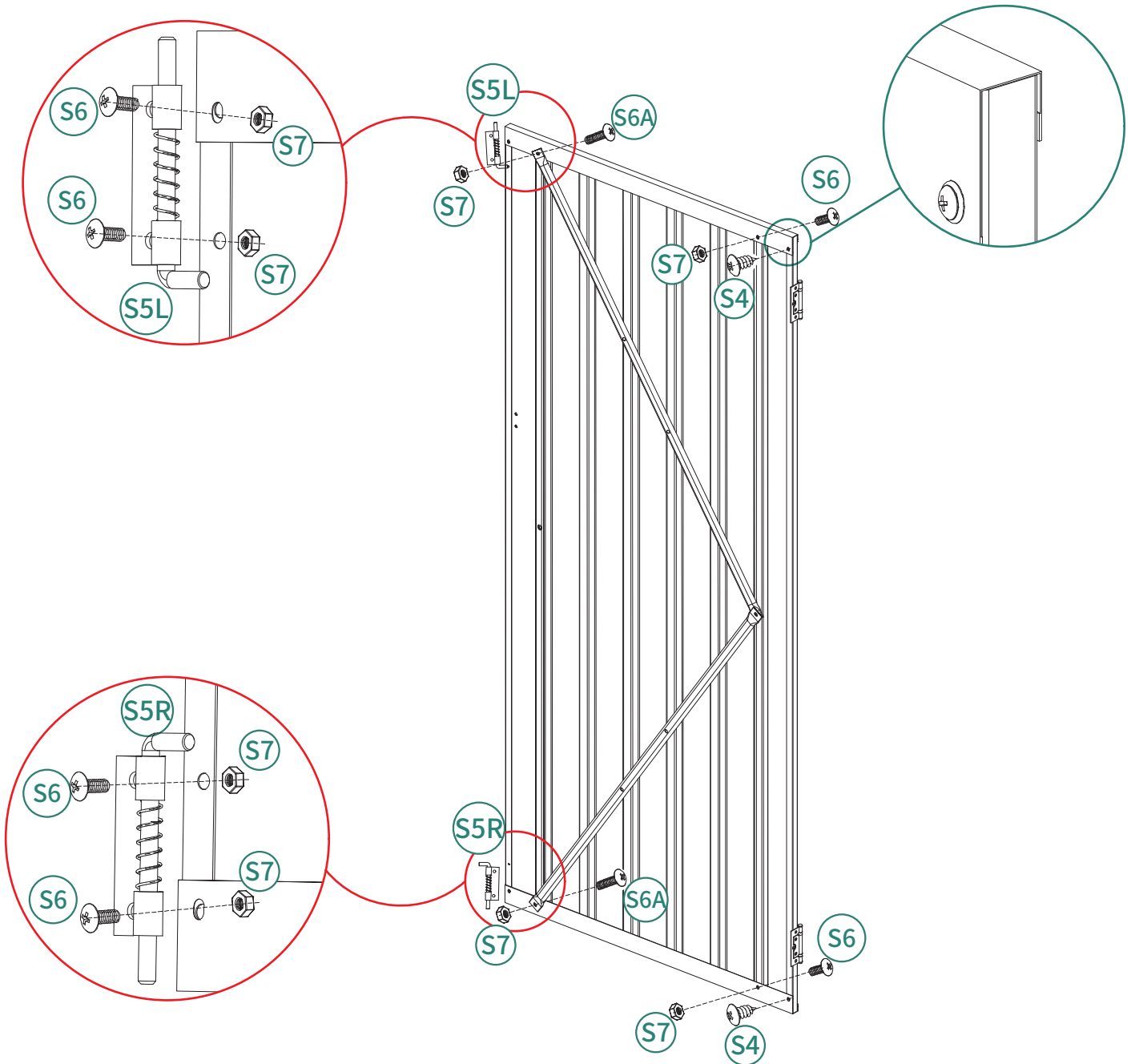

# 23

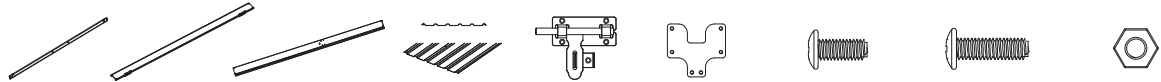
- 
- ⑮ 2pcs ⑯ 1pc ⑰ 1pc M1 1pc S2 1pc S3 1pc S6 7pcs S6A 3pcs S7 4pcs

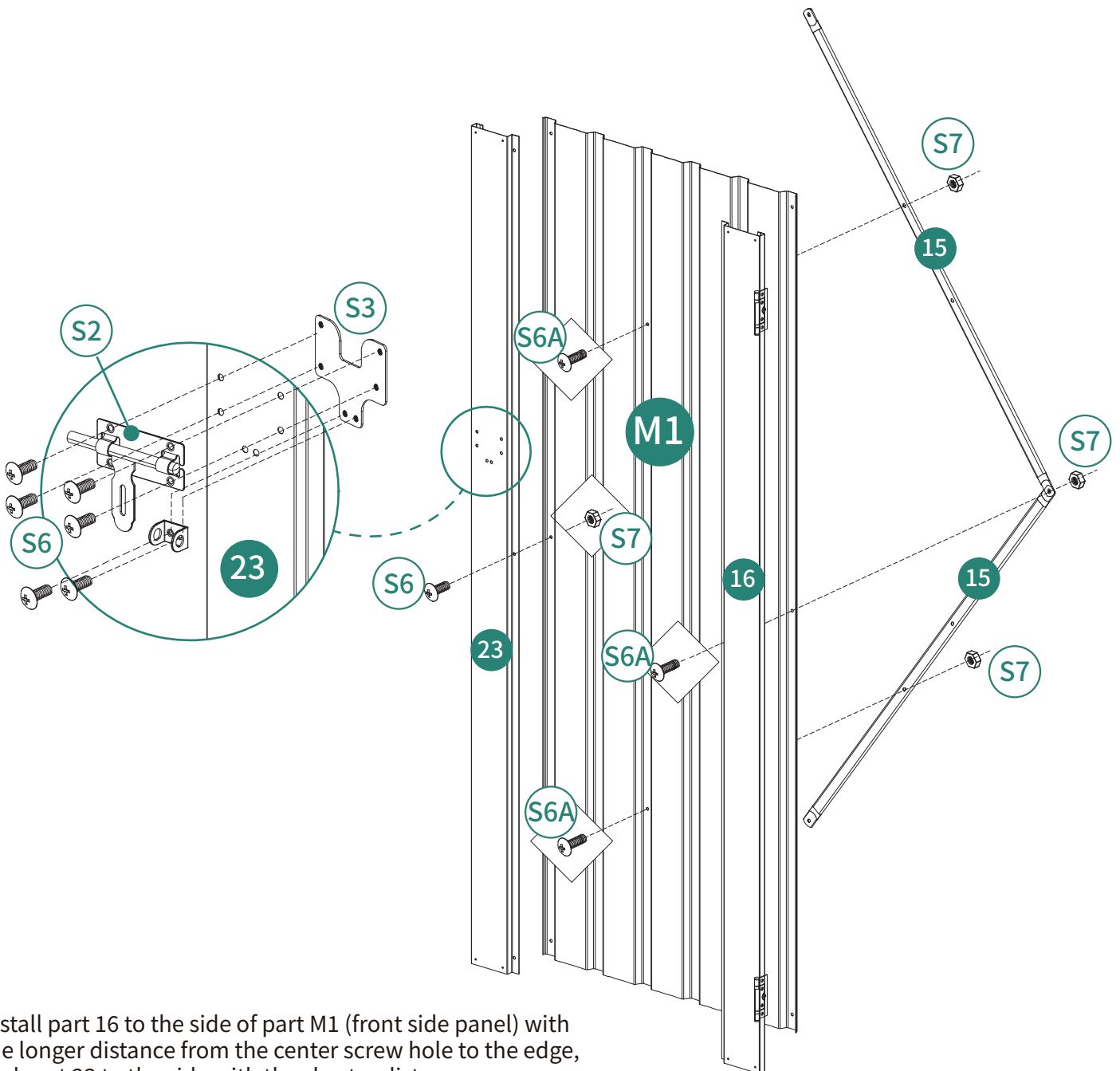

Install part 16 to the side of part M1 (front side panel) with the longer distance from the center screw hole to the edge, and part 23 to the side with the shorter distance.

24



21) 2pcs



S4) 8pcs

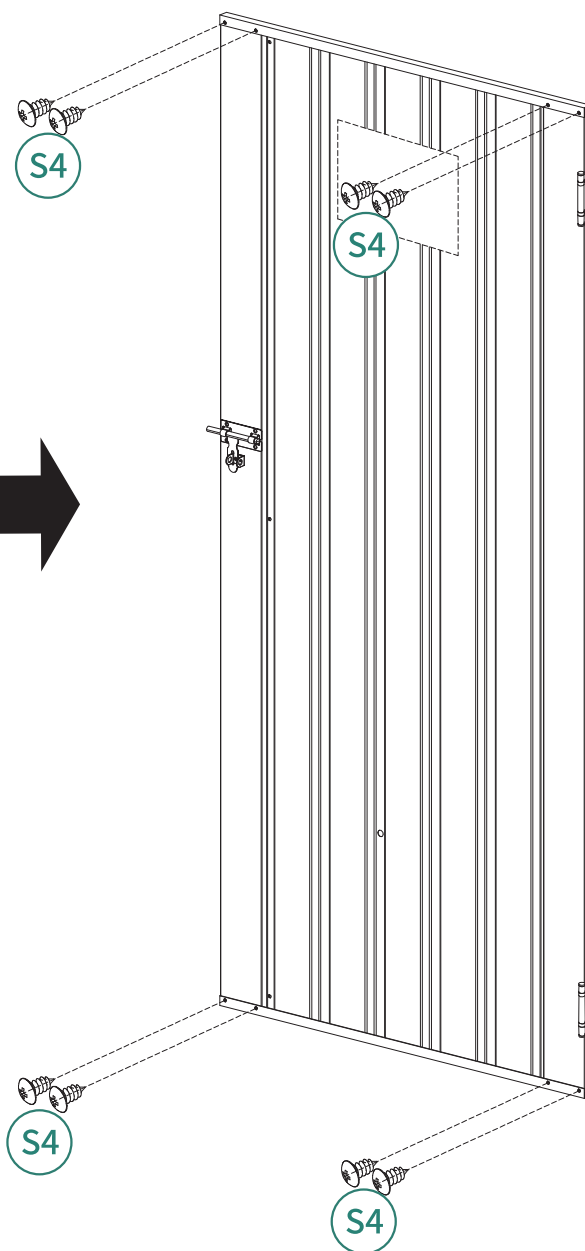
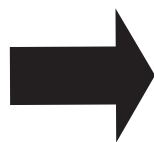
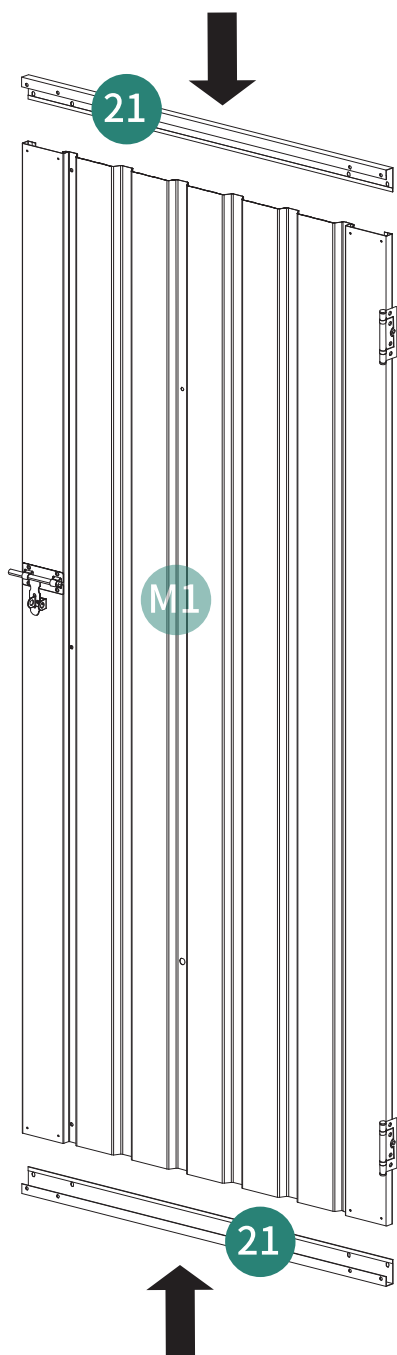

25



S4 4pcs

S6 2pcs

S6A 2pcs

S7 4pcs

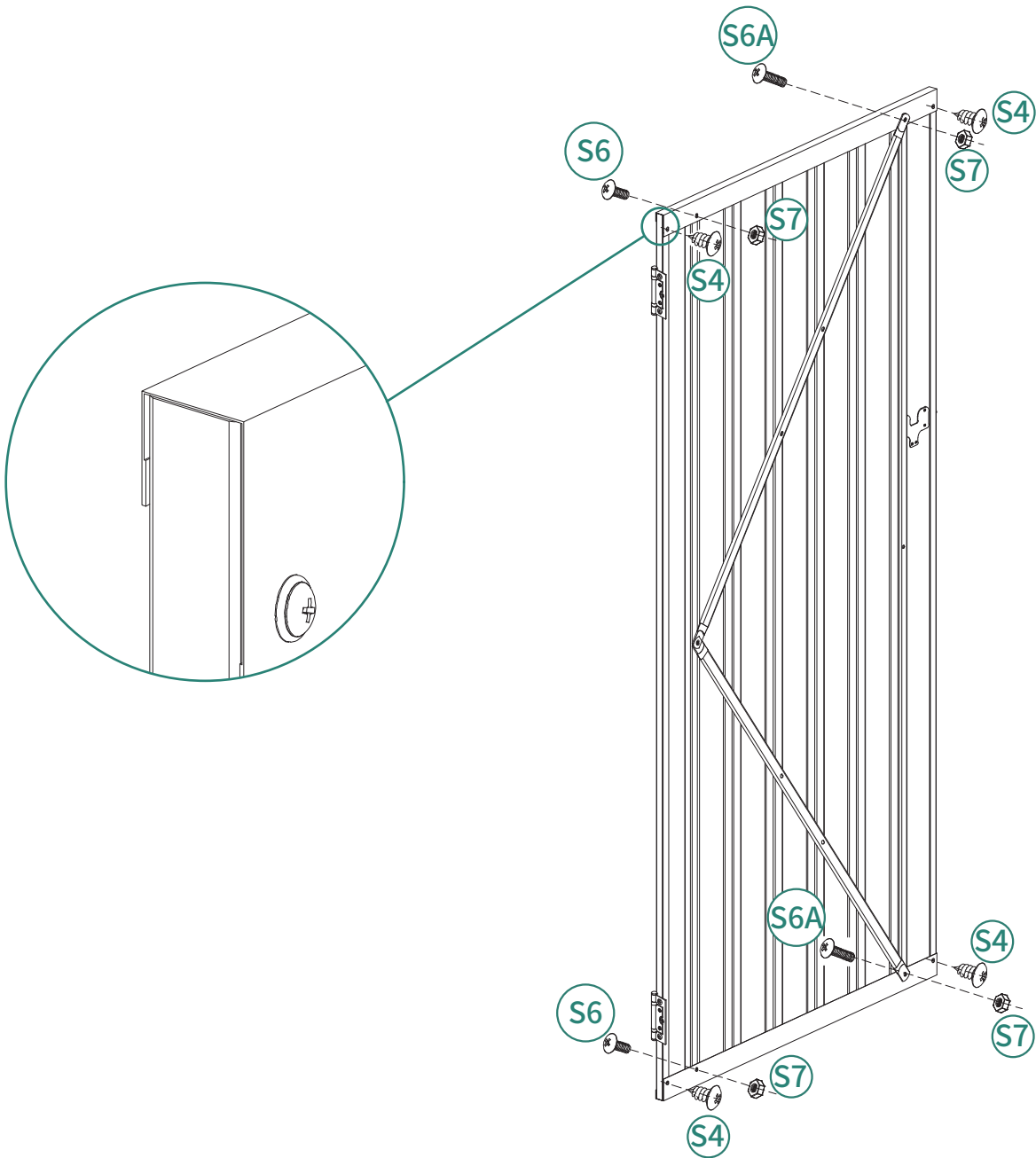

26

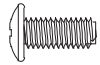

S6 12pcs

S7 12pcs

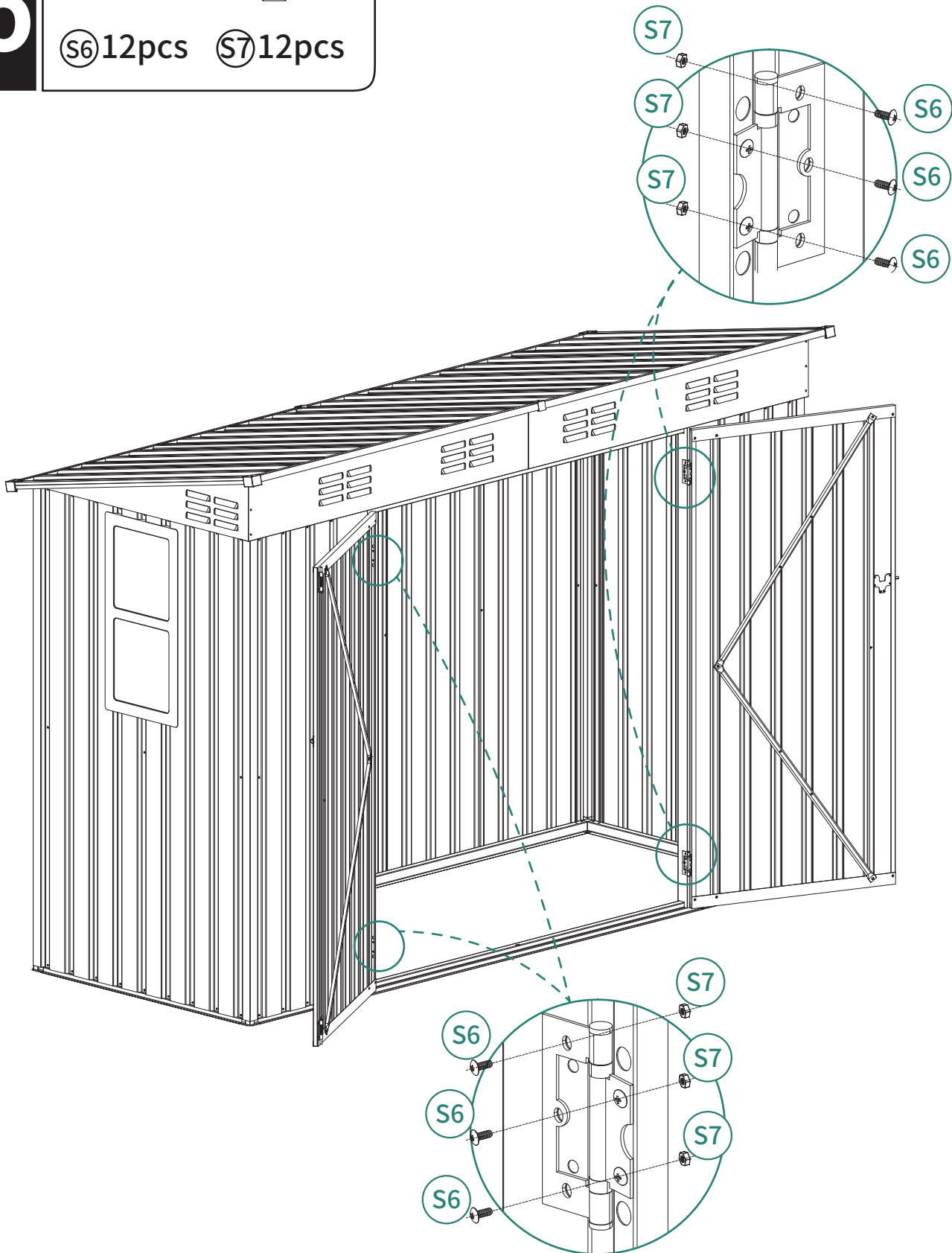

# 27



(S9) 4pcs

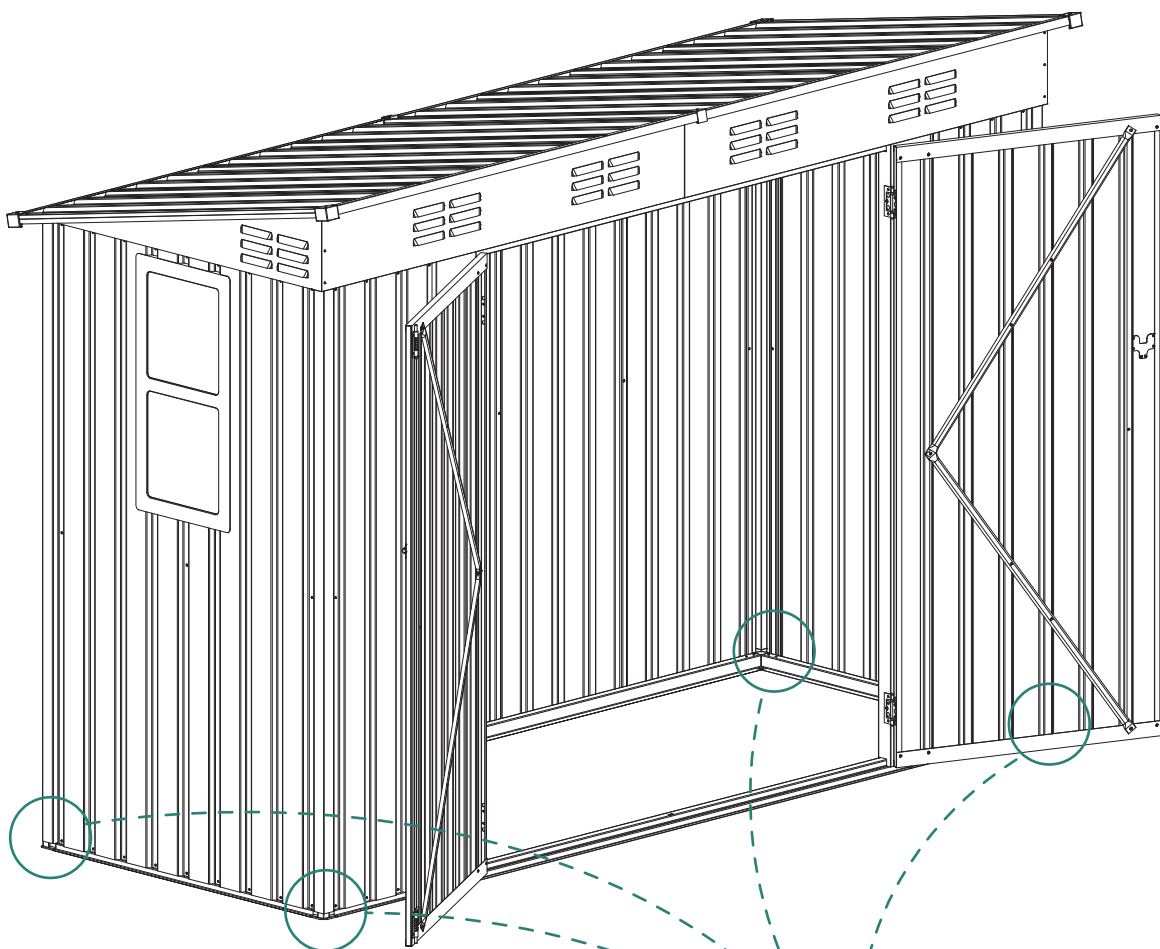

To improve the wind resistance, please be sure to complete this installation step. If expansion bolts or ground stakes are not installed, strong winds may cause the tool shed to collapse. Expansion bolts are crucial for the stability on concrete surfaces, and ground stakes are used for grassy areas. The accessory package includes the ground stake components, but the expansion bolts are not included.

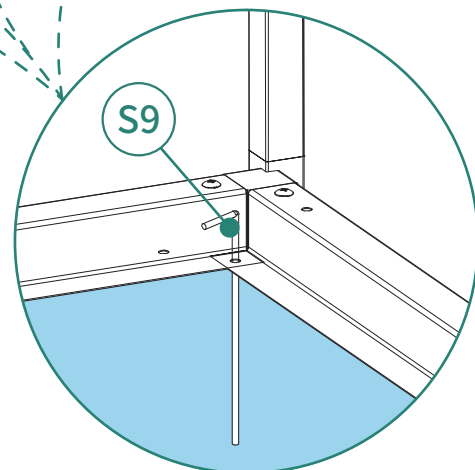

28

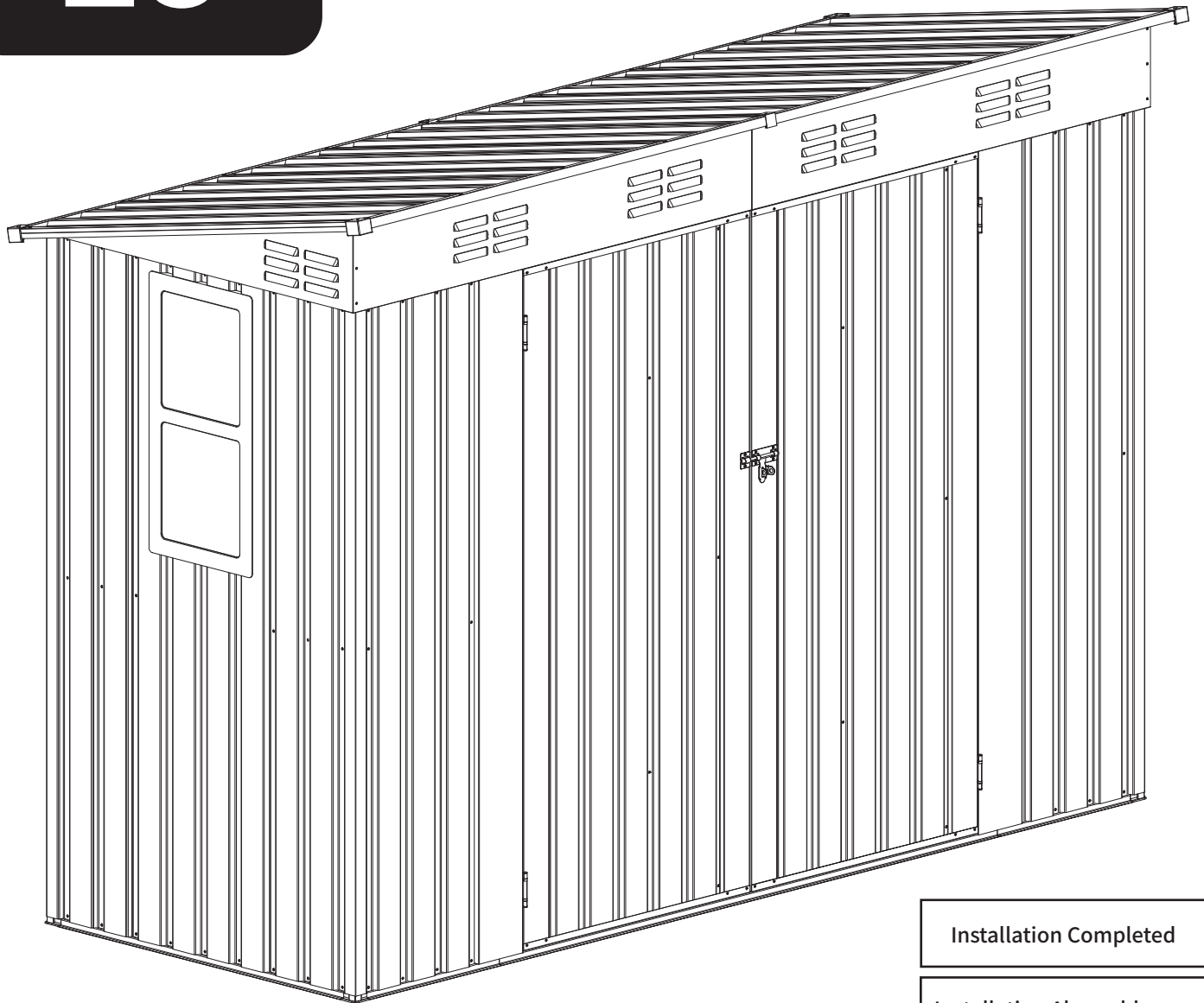

Installation Completed

Installation Abgeschlossen

Installation Complétée

Installazione Completata

Instalación Completada

# HELP CENTER



Inquiry



Assembly issue



Missing parts

If you encounter any difficulties during assembly, please contact us.

Wenn Sie während der Montage auf Schwierigkeiten stoßen, kontaktieren Sie uns bitte.

Si vous rencontrez des difficultés lors du montage, veuillez nous contacter.

Se incontri difficoltà durante il montaggio, ti preghiamo di contattarci.

Si encuentras alguna dificultad durante el ensamblaje, por favor contáctanos.

# DISCLAIMER

Manufacturer and seller expressly disclaim any and all liability for personal injury, property damage or loss, whether direct, indirect, or incidental, resulting from the incorrect attachment, improper use, inadequate maintenance, unapproved modification, or neglect of this product.

Der Hersteller und Verkäufer lehnen ausdrücklich jegliche Haftung für Personenschäden, Sachschäden oder Verluste ab, egal ob direkt, indirekt oder zufällig, die durch falsche Anbringung, unsachgemäßen Gebrauch, unzureichende Wartung, nicht genehmigte Änderungen oder Vernachlässigung dieses Produkts entstehen.

El fabricante y vendedor renuncian expresamente a toda responsabilidad por lesiones personales, daños materiales o pérdidas, ya sean directos, indirectos o incidentales, derivados de la incorrecta colocación, uso inadecuado, mantenimiento insuficiente, modificación no aprobada o negligencia de este producto.

Il produttore e il venditore declinano espressamente ogni responsabilità per lesioni personali, danni materiali o perdite, dirette, indirette o incidentali, derivanti dall'errato fissaggio, uso improprio, manutenzione inadeguata, modifica non autorizzata o negligenza di questo prodotto. Le fabricant et le vendeur déclinent expressément toute responsabilité en cas de blessures corporelles, de dommages matériels ou de pertes, qu'ils soient directs, indirects ou accessoires, résultant de la fixation incorrecte, de l'utilisation inappropriée, de l'entretien insuffisant, de la modification non approuvée ou de la négligence de ce produit.