

# Cabinet > Manual

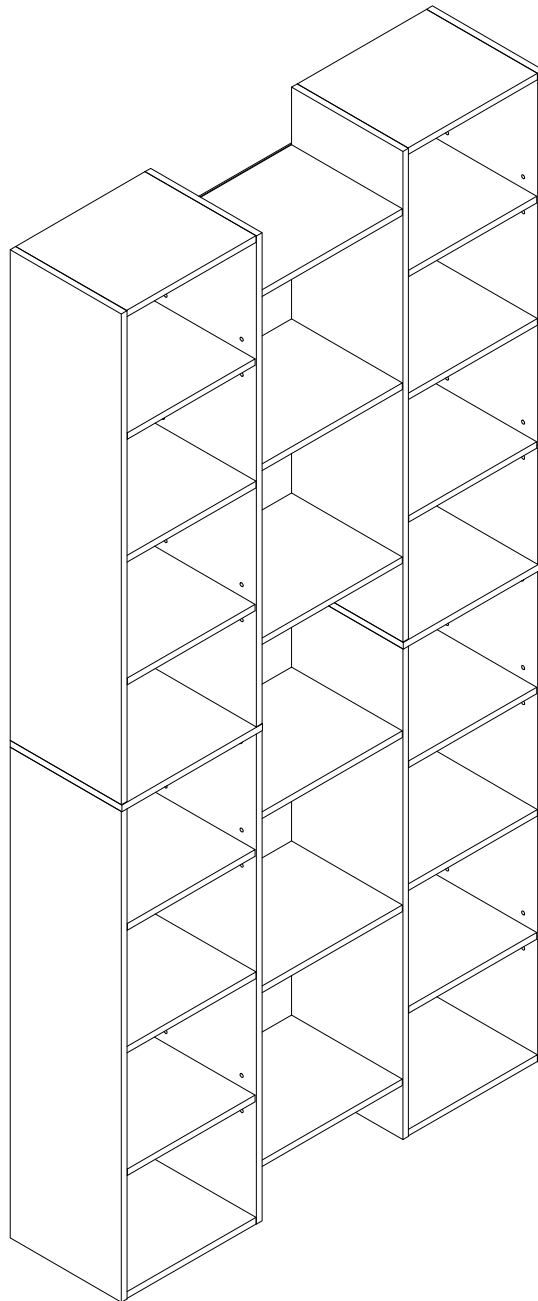

Thank you for purchase on our products. Please contact us if you have difficulty with assembly or need replacement parts. Our customer service is here to assist you. Please attach your User Name or Order ID so that we can assist you better.

Vielen Dank für Ihren Kauf von uns Produkten. Bitte kontaktieren Sie uns, wenn Sie Probleme mit Montage haben oder Ersatzteile benötigen. Wir Kundenservice ist für Sie da. Bitte geben Sie Ihren Benutzernamen oder Ihre Bestellnummer an, damit wir Sie besser unterstützen können.

**EN**

## **WARNING**

Serious or fatal injury may occur from unexpected assembly or use.

1. During the assembly process, keep all parts away from babies or children.
2. Always securely fix this product to the wall. Make sure the wall area to be drilled is free from hidden electrical wires, water and gas pipes.
3. Use of tip-over restraints may only reduce, but not eliminate the risk of tip-over.
4. Unless specially designed to accommodate, do not set heavy objects on top of this product.
5. Place the heaviest items on the lowest shelf.
6. Never allow children to climb or bang on drawers, doors or shelves.

**DE**

## **WARNUNG**



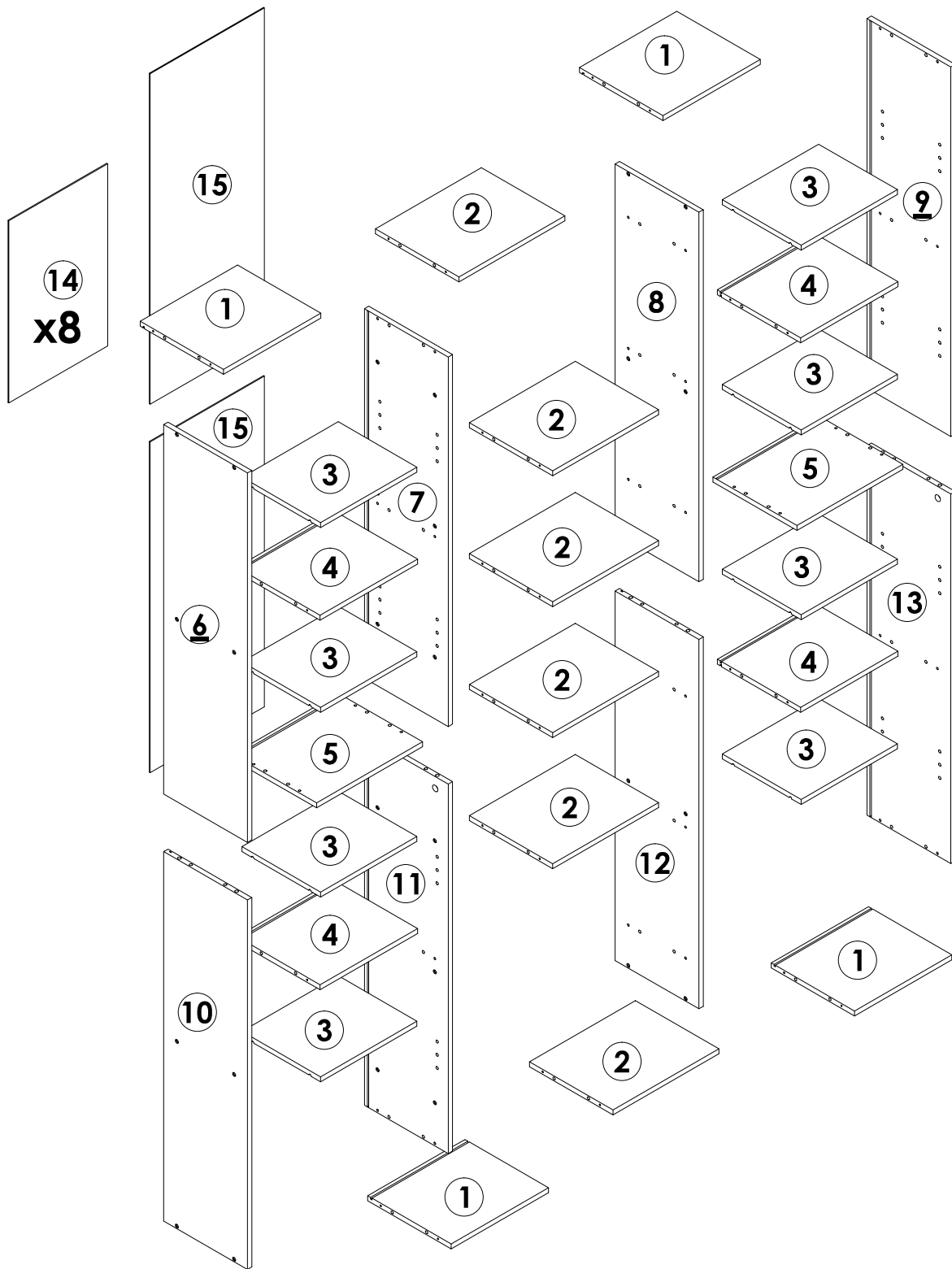

Bei unerwarteter Montage oder Verwendung können schwere oder tödliche Verletzung auftreten.

1. Legen Sie in den Montageprozess alle Teile weg von Babys oder Kindern.
2. Stellen Sie sicher, dass der gebohrte Wandbereich frei von verborgenen Stromkabeln, Wasser- und Gasleitungen ist, wenn Sie dieses Produkt an der Wand befestigen.
3. Die Verwendung von Kippsicherungen kann die Gefahr eines Kippens nur verringern, jedoch nicht beseitigen.
4. Setzen Sie bitte keine schweren Gegenstände auf dieses Produkt, es sei denn, dass das Produkt speziell für die Unterbringung konzipiert wird.
5. Legen Sie bitte die schwersten Gegenstände auf das unterste Regal.
6. Erlauben Sie nie Kindern, auf Schubladen, Türen oder Regale zu klettern oder zu knallen.

# Parts List(EN) / Teile Liste(DE)

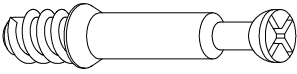
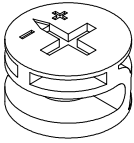
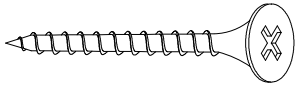

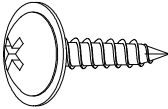
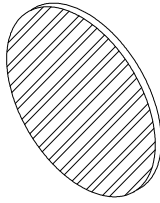
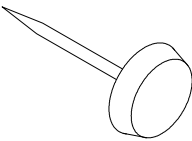
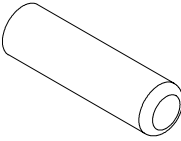
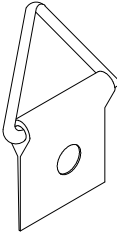
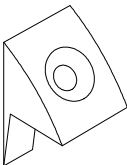
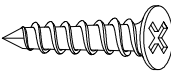
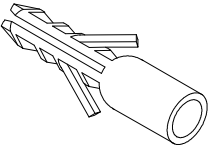
## Parts List(EN) / Teile Liste(DE)

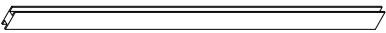
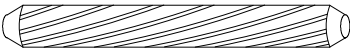
<p><b>A</b></p>  <p>M6x35mm      8+1PCS</p>	<p><b>B</b></p>  <p>Ø15x9mm      8+1PCS</p>	<p><b>C</b></p>  <p>M4x40mm      66+2PCS</p>
<p><b>D</b></p>  <p>Ø6x30mm      56+2PCS</p>	<p><b>E</b></p>  <p>M3x14mm      16+2PCS</p>	<p><b>F</b></p>  <p>Ø20mm      64+2PCS</p>
<p><b>G</b></p>  <p>8+1PCS</p>	<p><b>H</b></p>  <p>M5x20mm      32+2PCS</p>	<p><b>I</b></p>  <p>4PCS</p>
<p><b>J</b></p>  <p>32+2PCS</p>	<p><b>K</b></p>  <p>M3x14mm      34+2PCS</p>	<p><b>L</b></p>  <p>M6x30mm      2PCS</p>
<p><b>M</b></p>  <p>2PCS</p>	<p><b>N</b></p>  <p>293mm      1PC</p>	<p><b>O</b></p>  <p>Ø6x50mm      8+1PCS</p>

# Assembly Steps(EN) / Montageschritte(DE)

## STEP 1

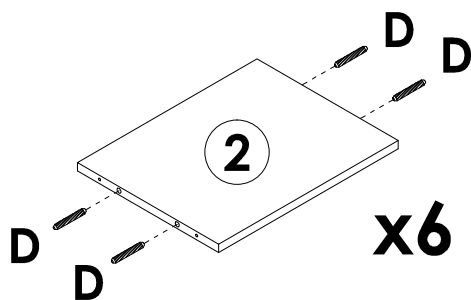

D x 24PCS

## STEP 2

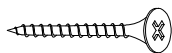
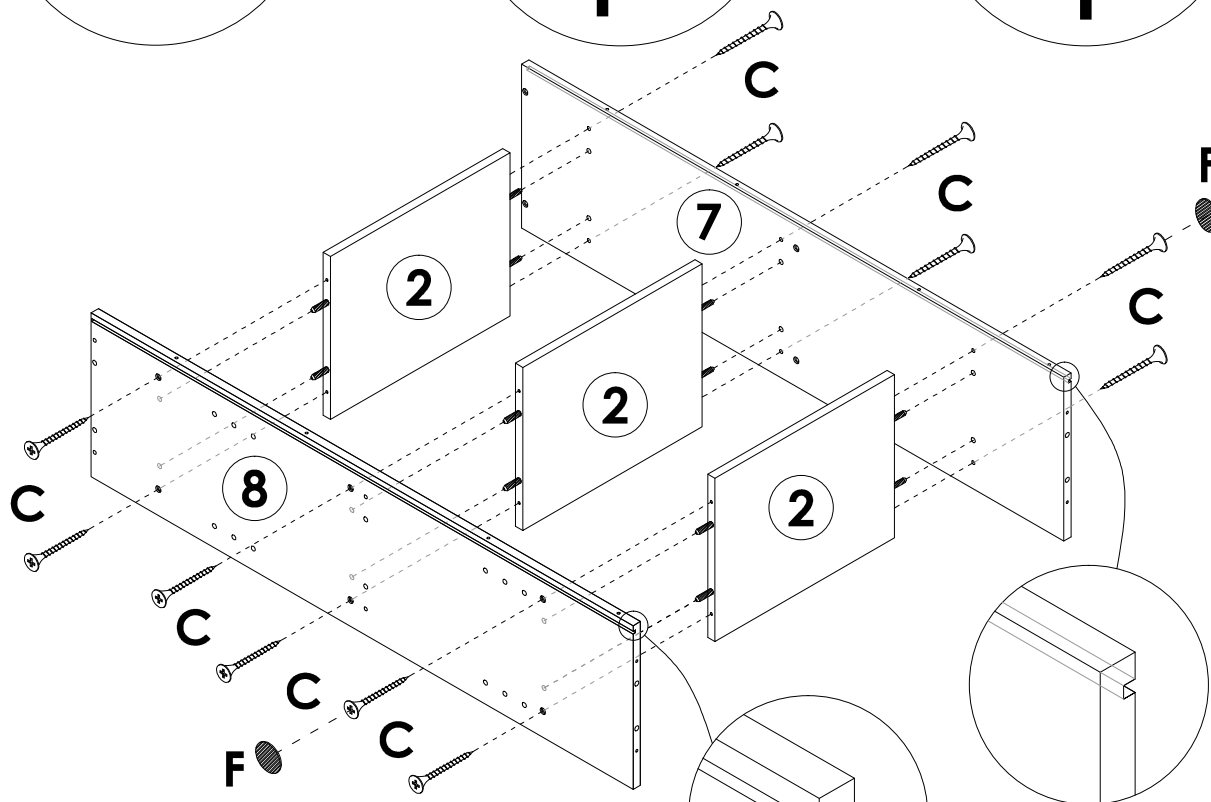
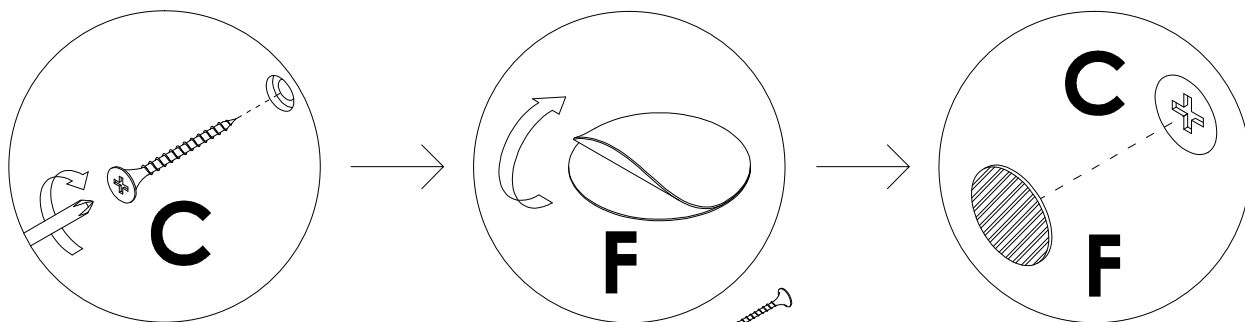

C x 12PCS



F x 12PCS

# Assembly Steps(EN) / Montageschritte(DE)

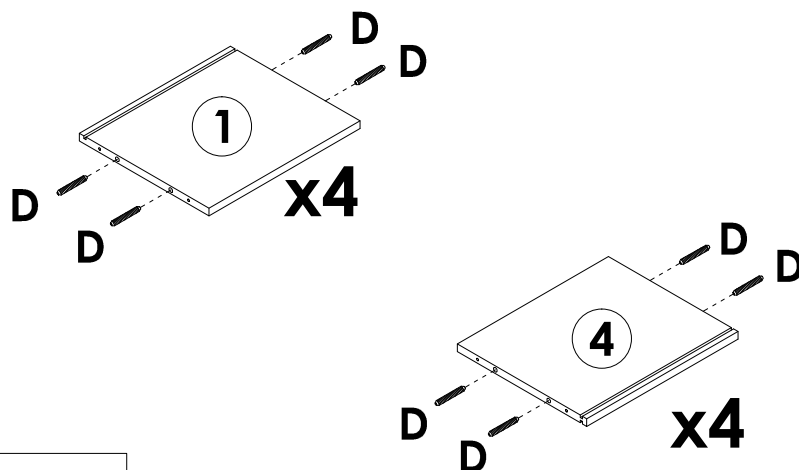

## STEP 3

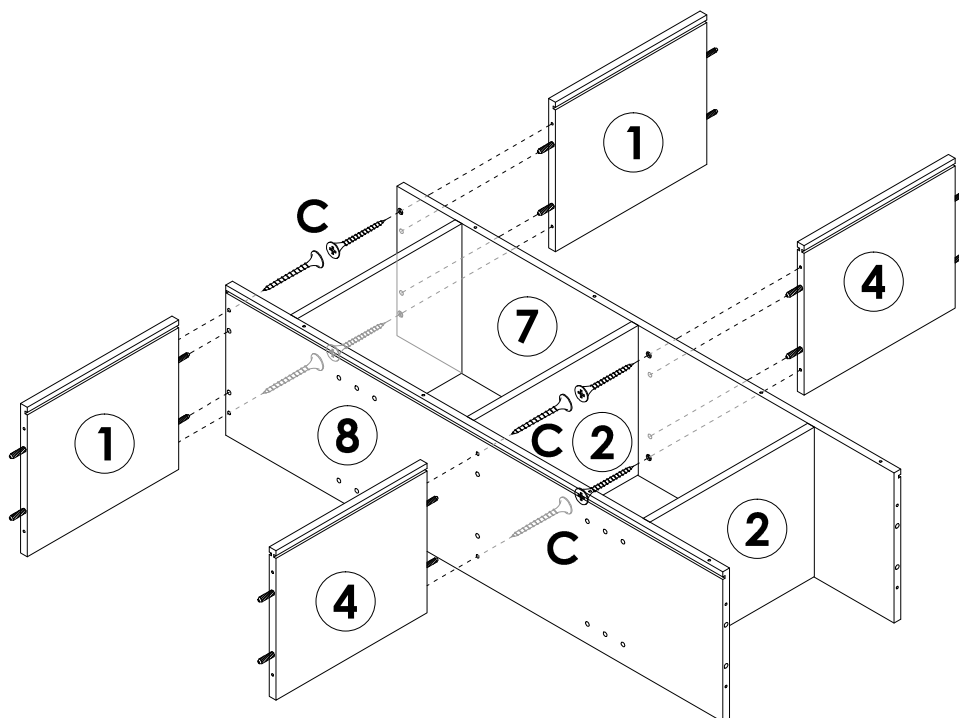
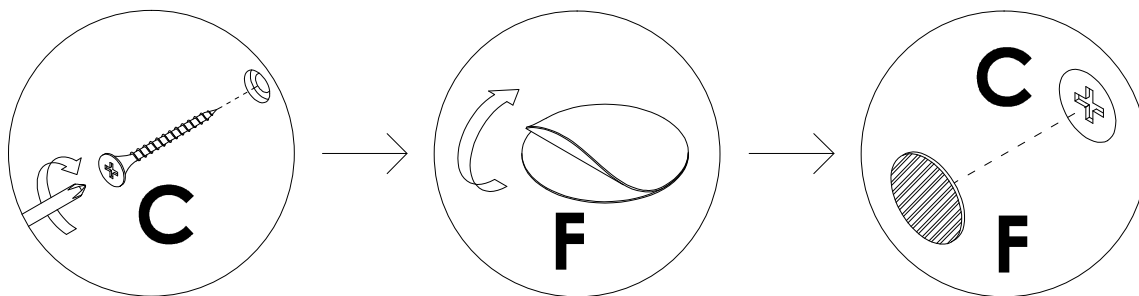

	<b>D x 32PCS</b>
---	------------------

## STEP 4

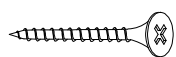

	<b>C x 8PCS</b>
	<b>F x 8PCS</b>

# Assembly Steps(EN) / Montageschritte(DE)

## STEP 5

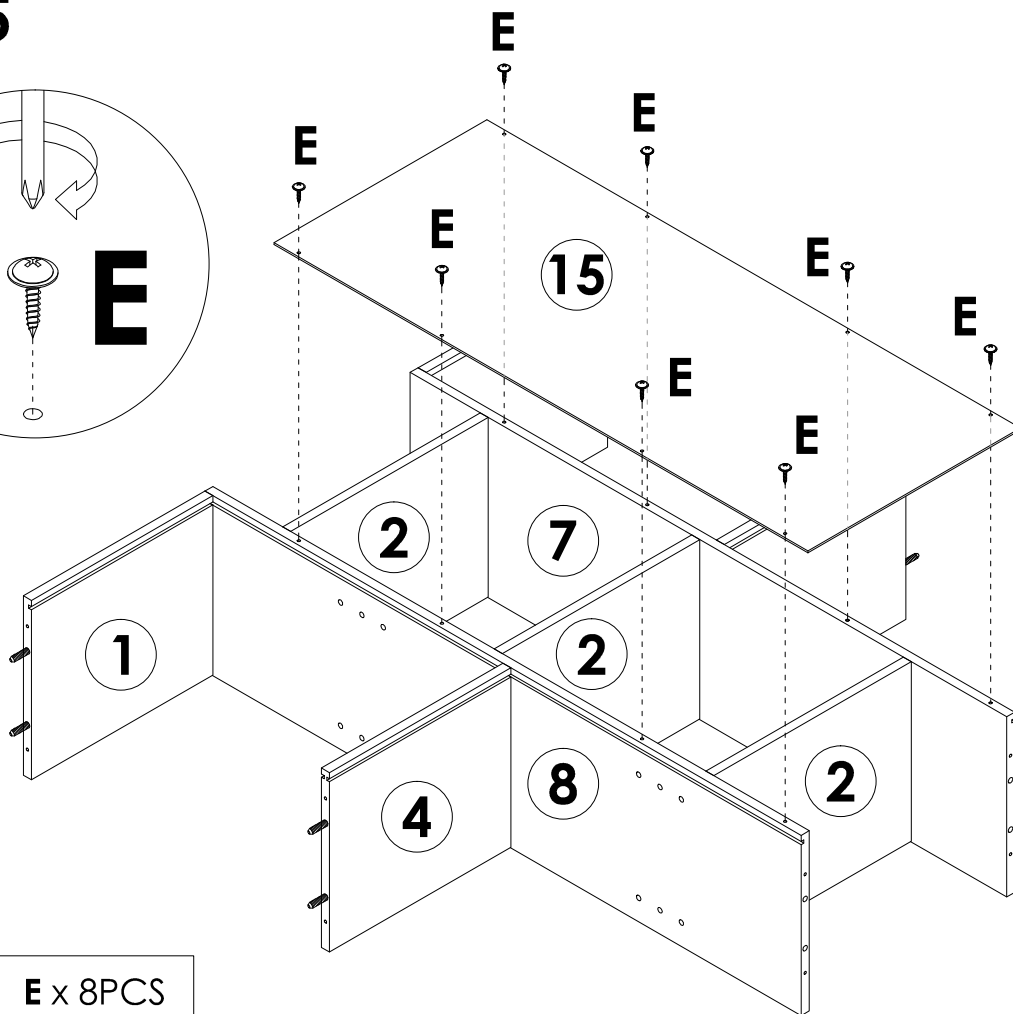
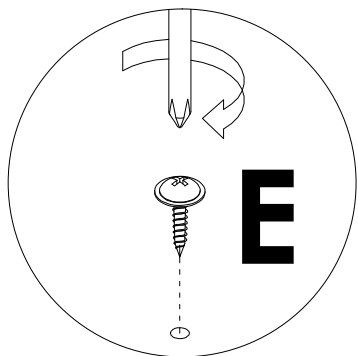

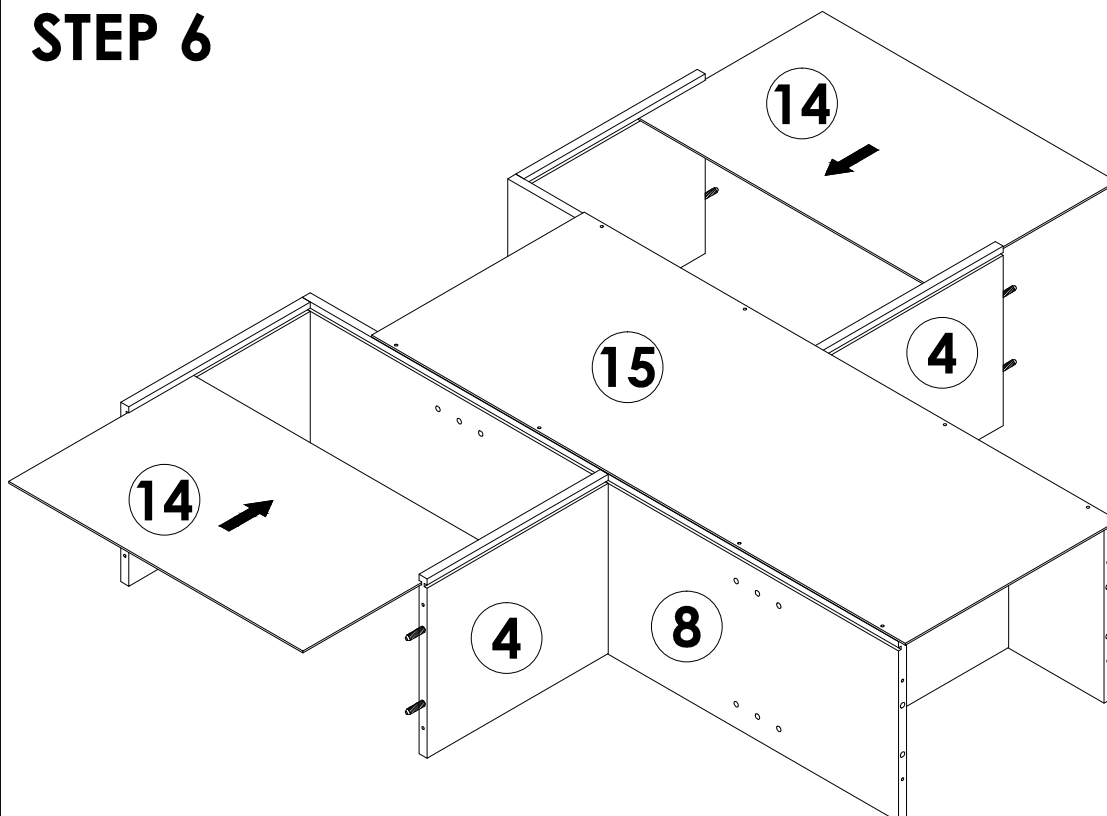

E x 8PCS

## STEP 6

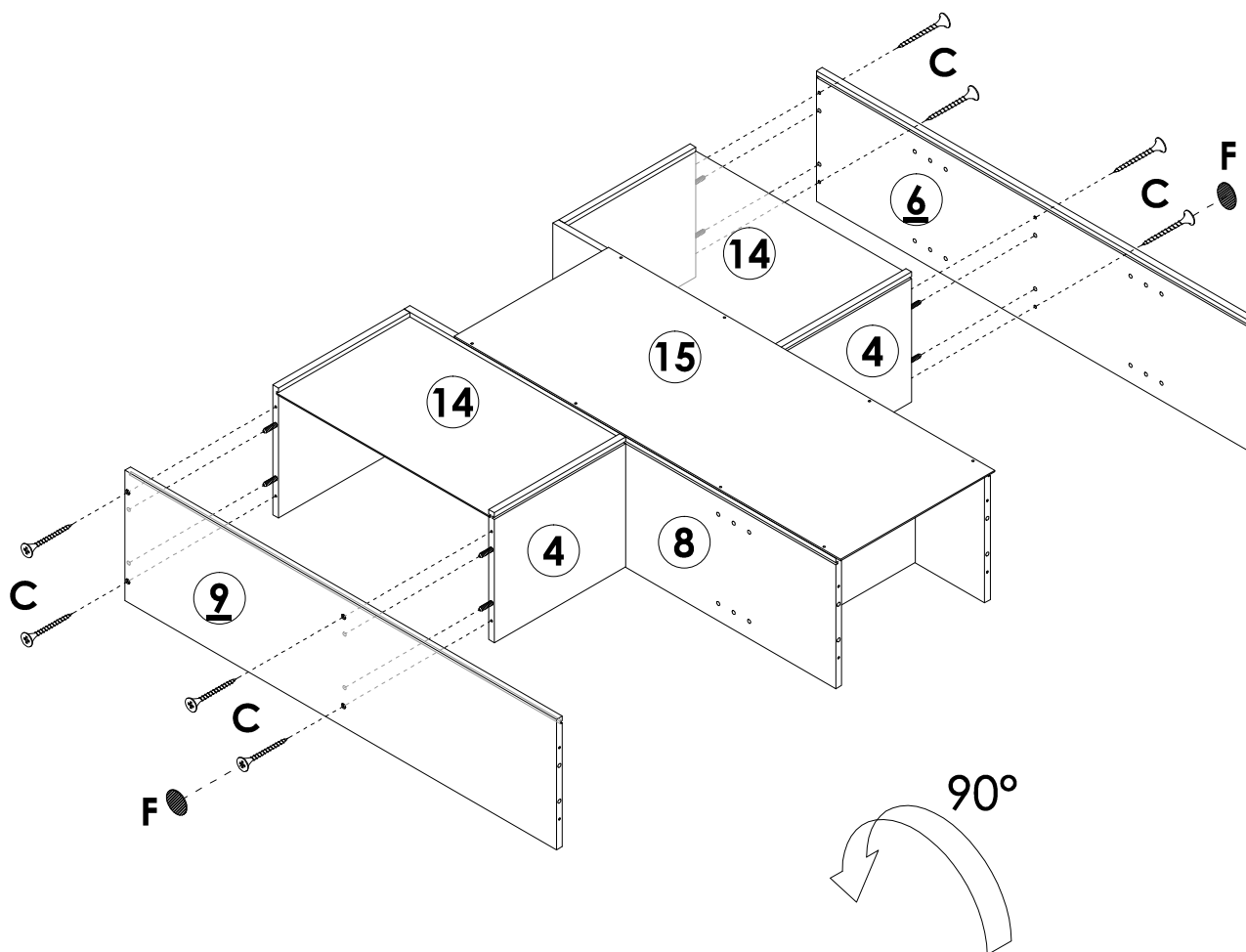
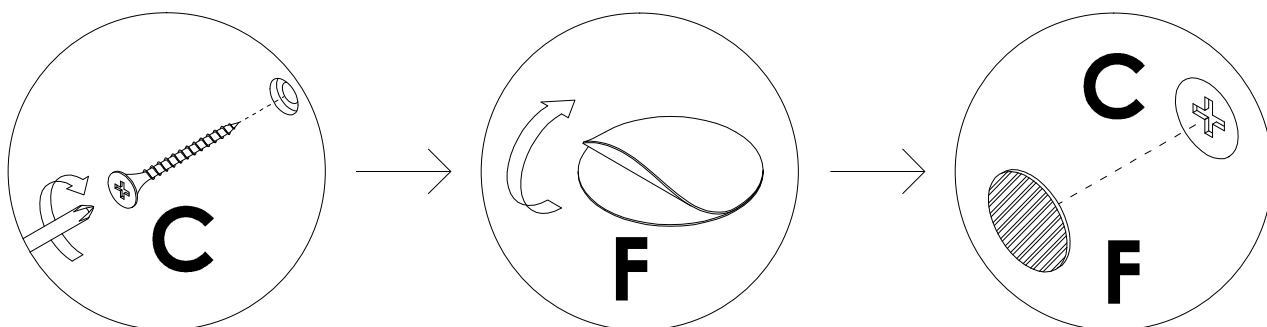

# STEP 7

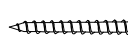

	<b>F</b> x 8PCS
	<b>C</b> x 8PCS

# STEP 8

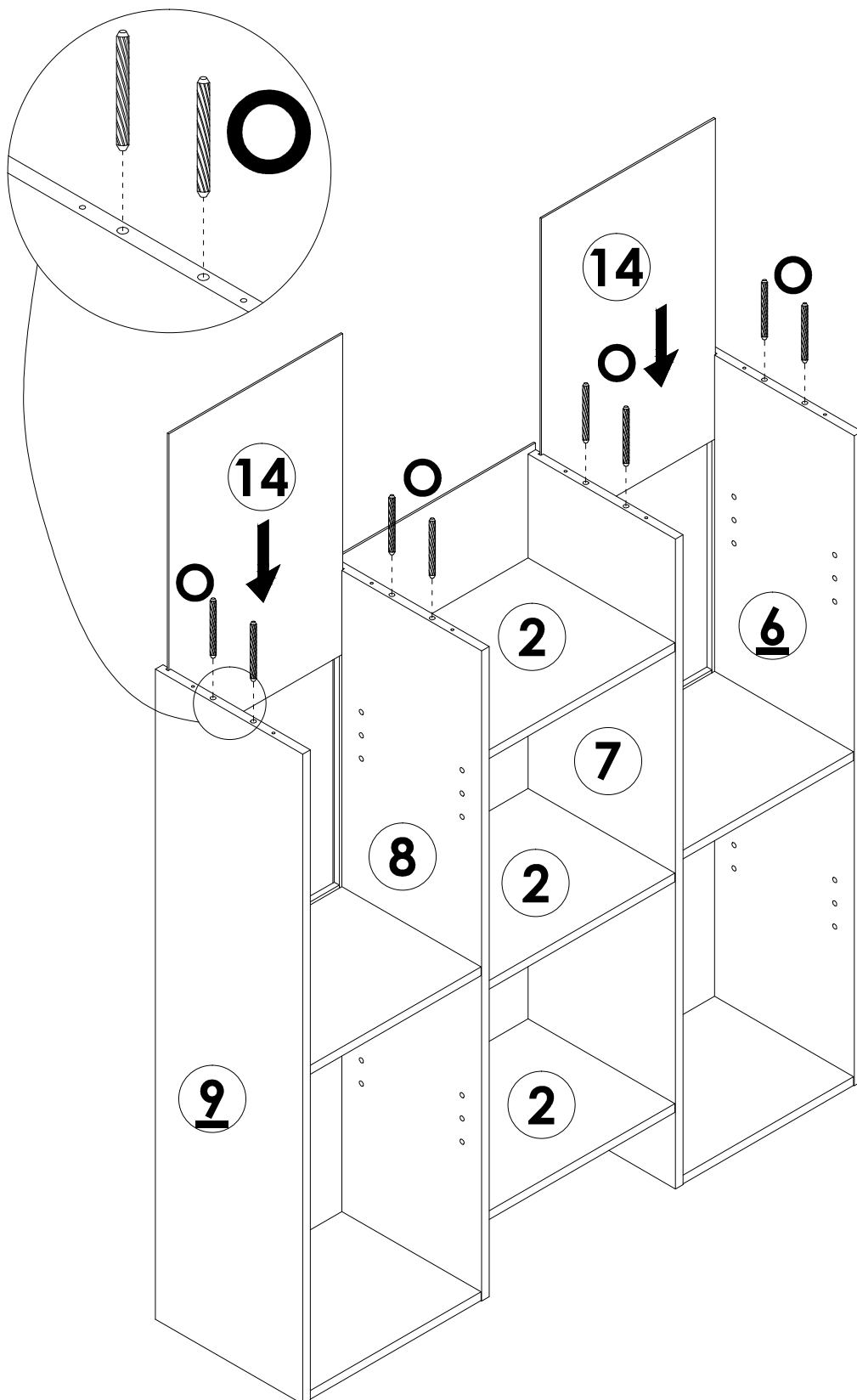

O x 8PCS

# Assembly Steps(EN) / Montageschritte(DE)

## STEP 9

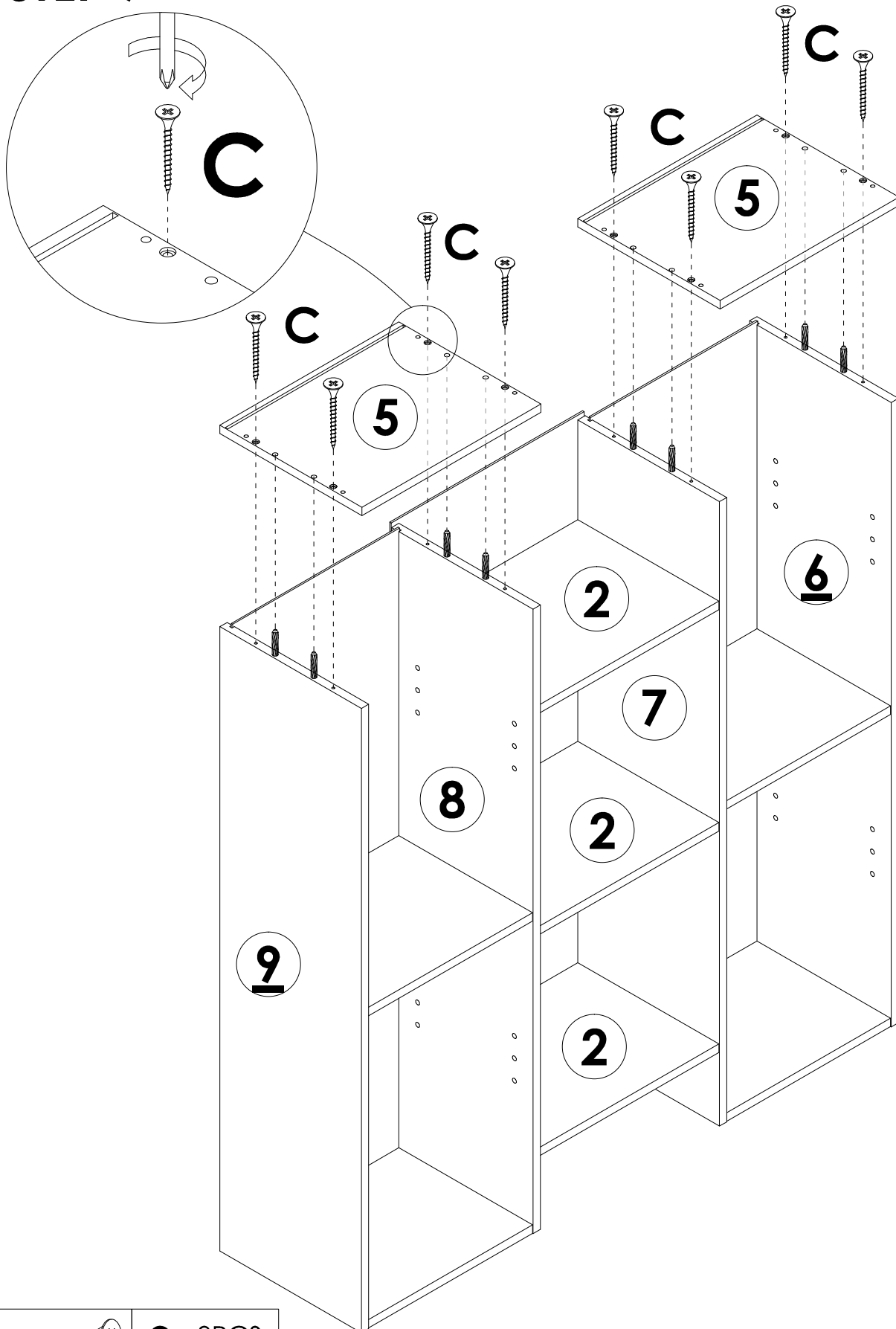

 C x 8PCS

# STEP 10

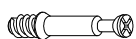
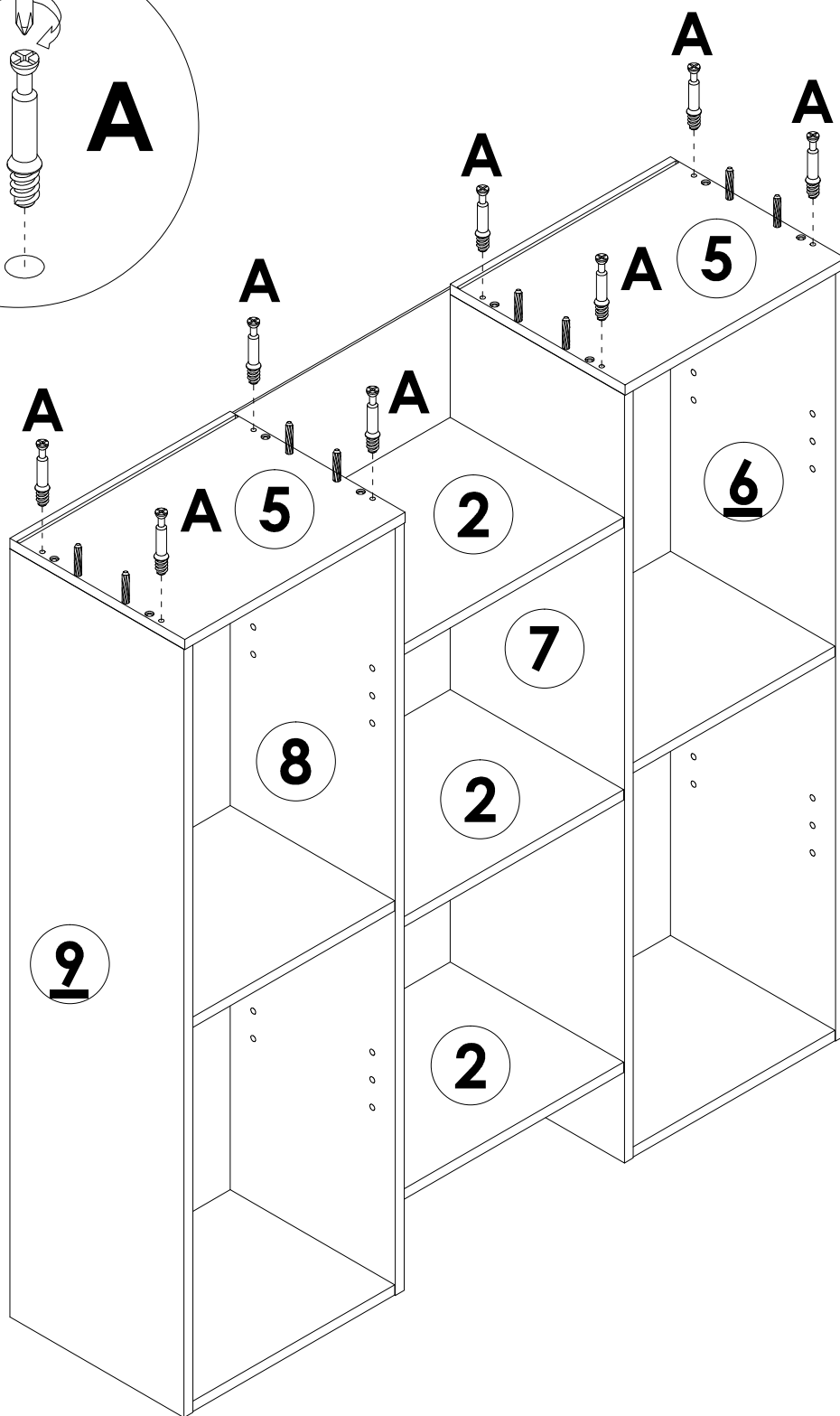
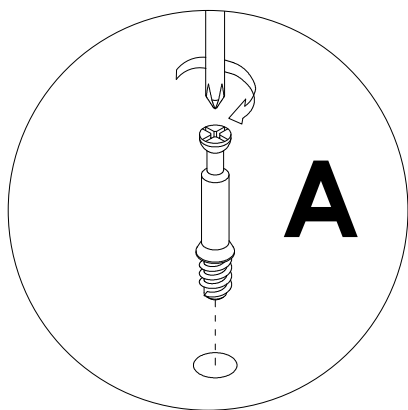



A x 8PCS

# Assembly Steps(EN) / Montageschritte(DE)

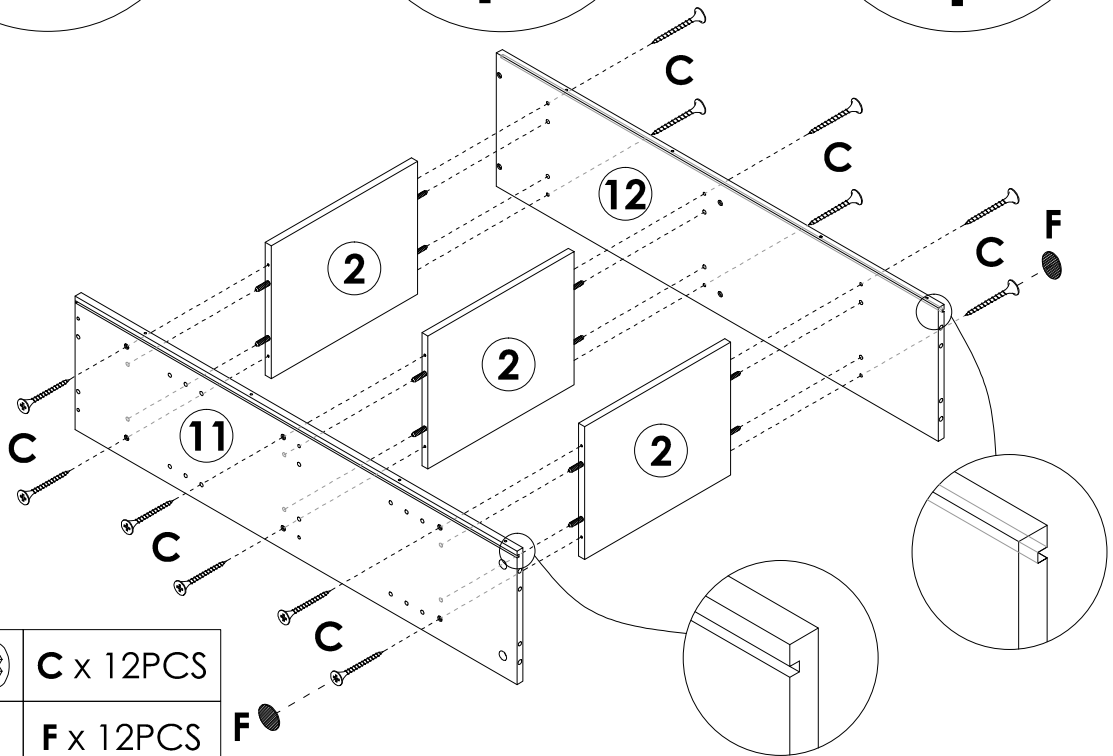
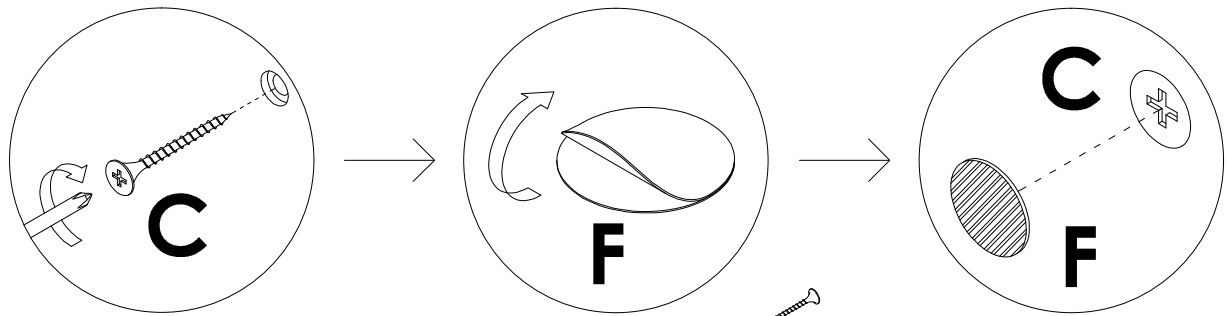

## STEP 11

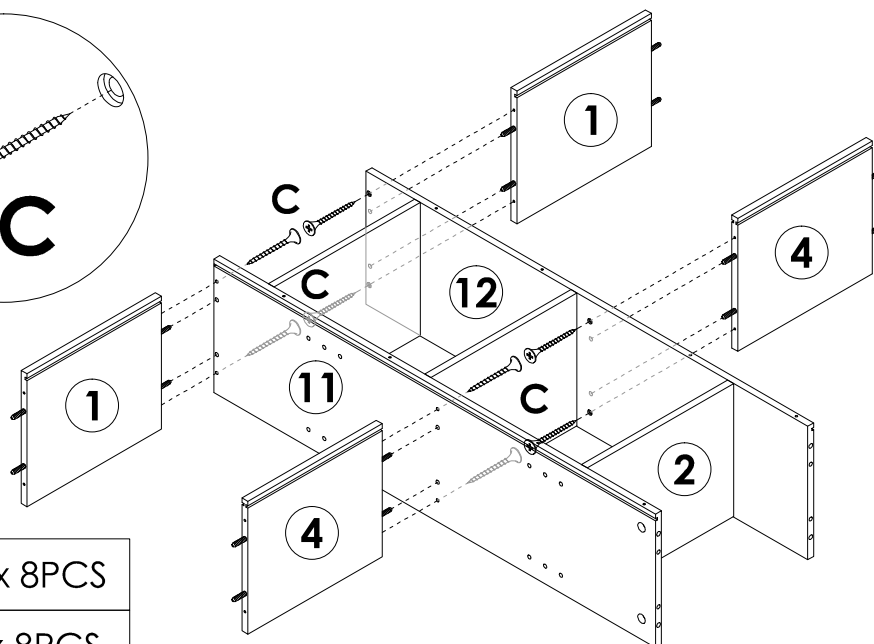
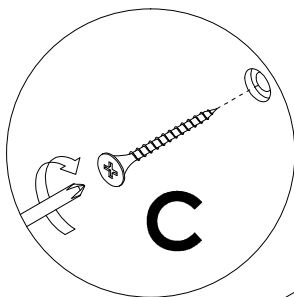

	<b>C x 12PCS</b>
	<b>F x 12PCS</b>

## STEP 12

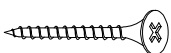

	<b>C x 8PCS</b>
	<b>F x 8PCS</b>

### STEP 13

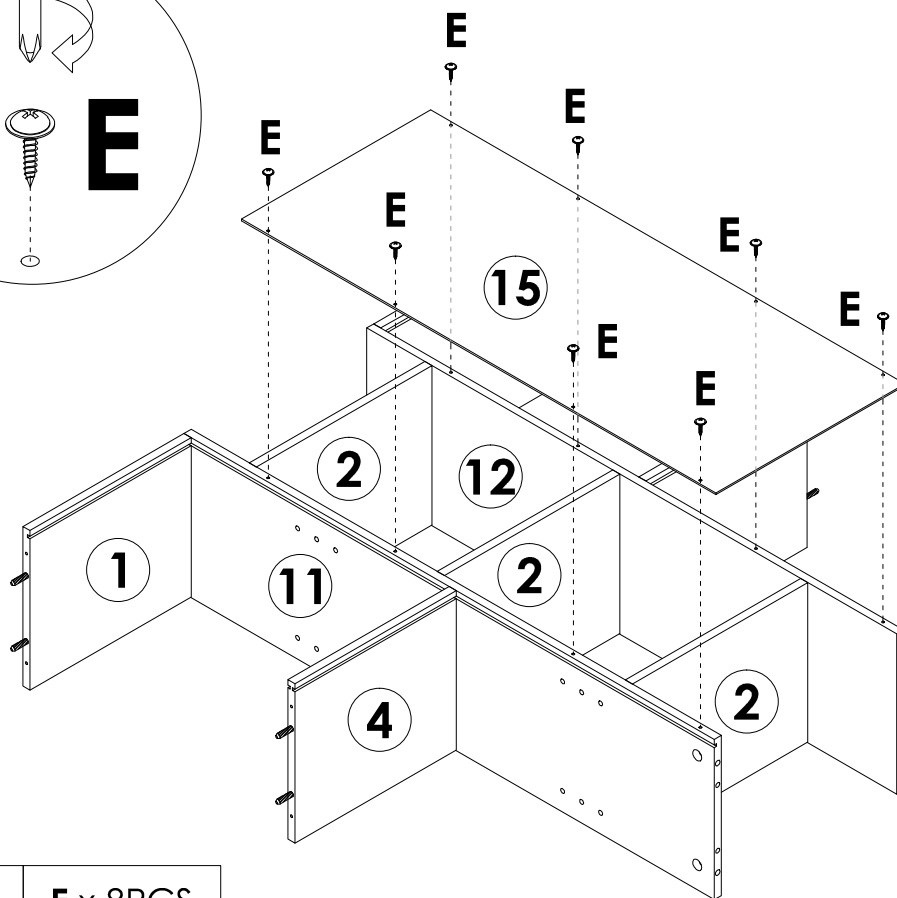
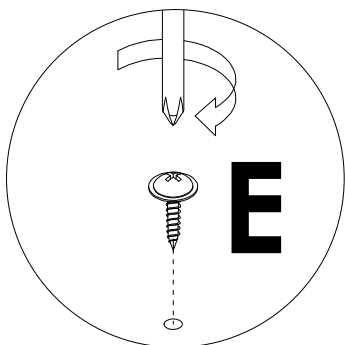

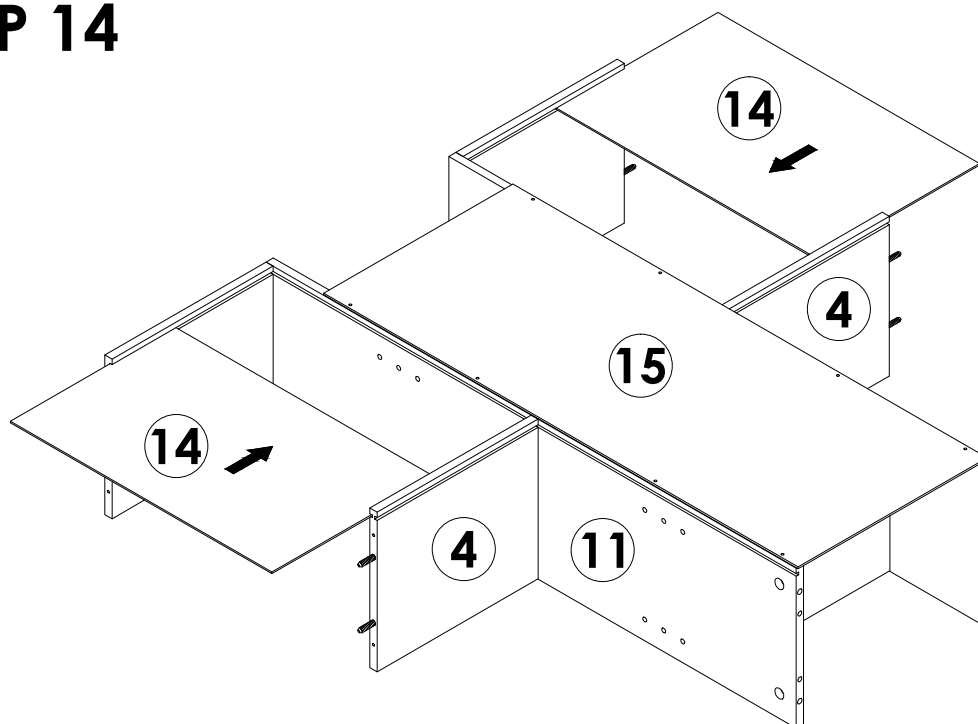

E x 8PCS

### STEP 14

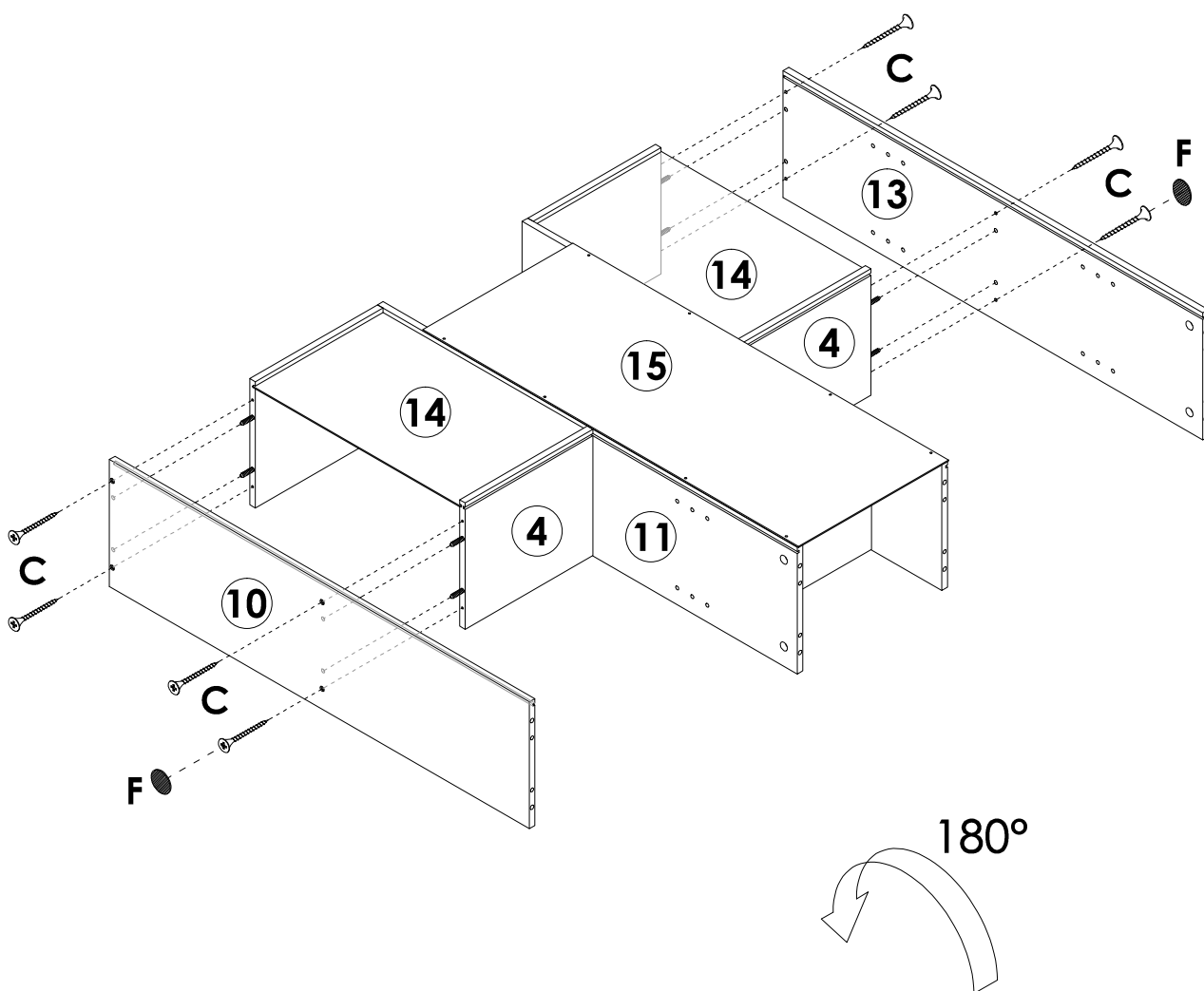
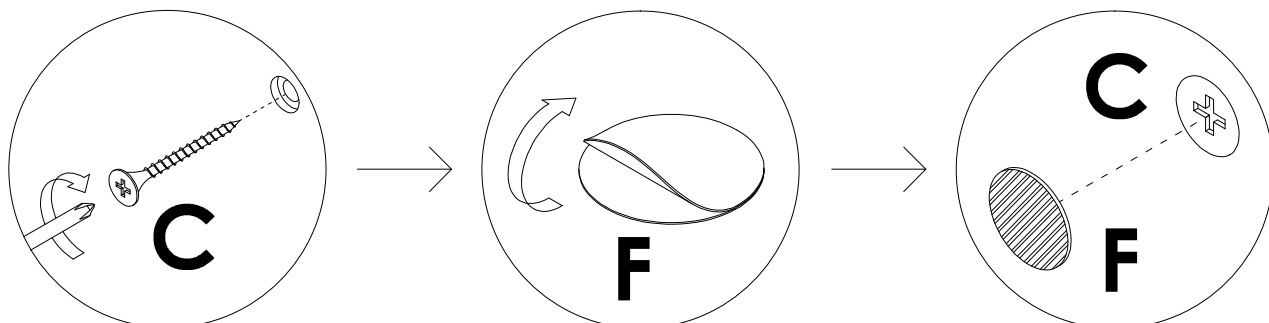

# STEP 15

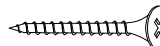

	<b>F</b> x 8PCS
	<b>C</b> x 8PCS

# Assembly Steps(EN) / Montageschritte(DE)

## STEP 16

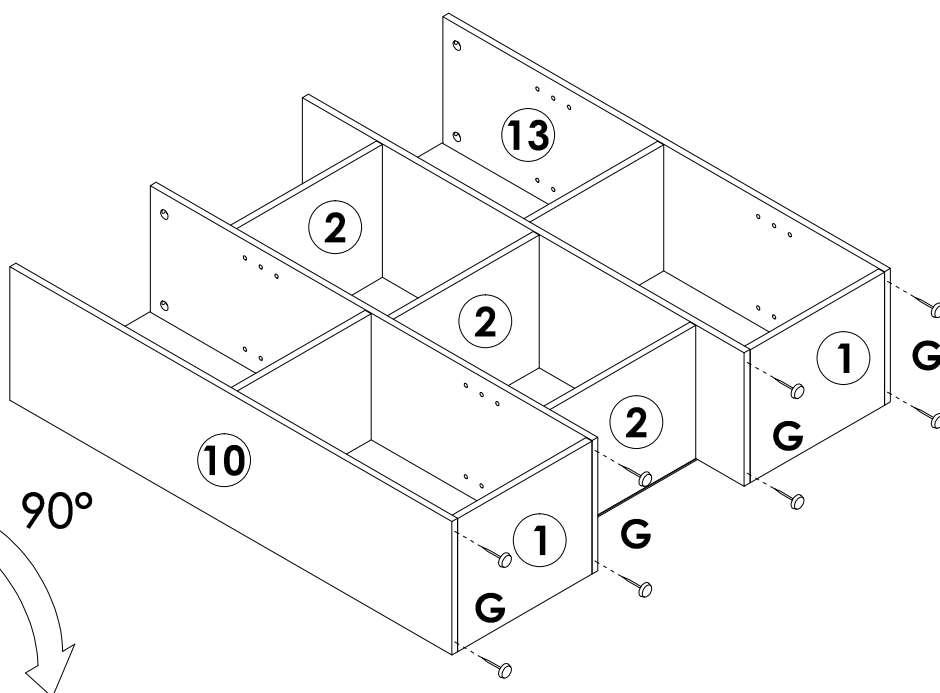
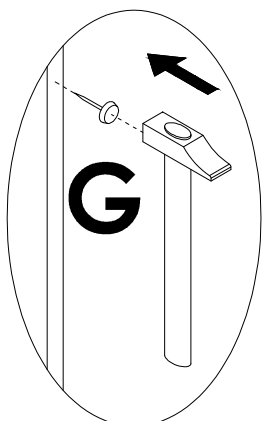

**G** x 8PCS

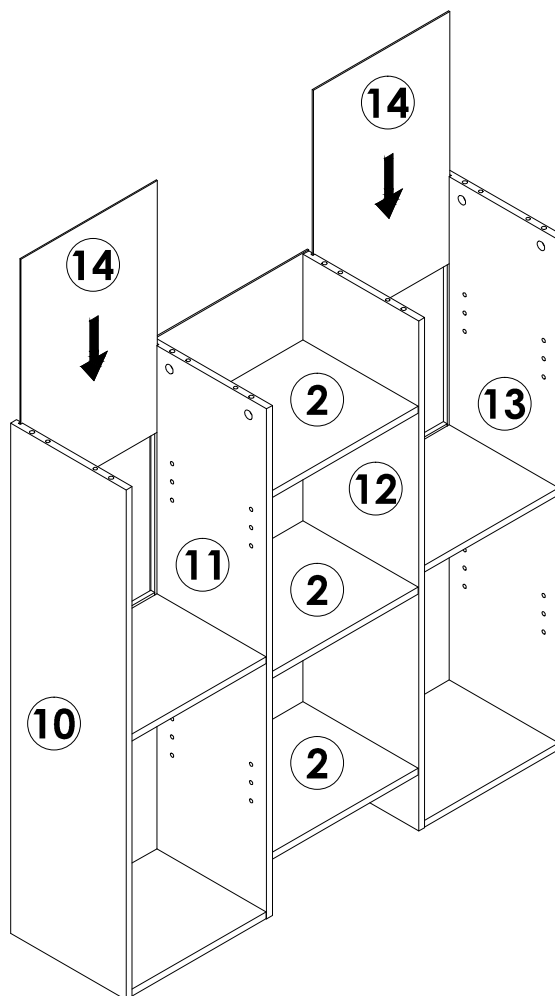

## STEP 17

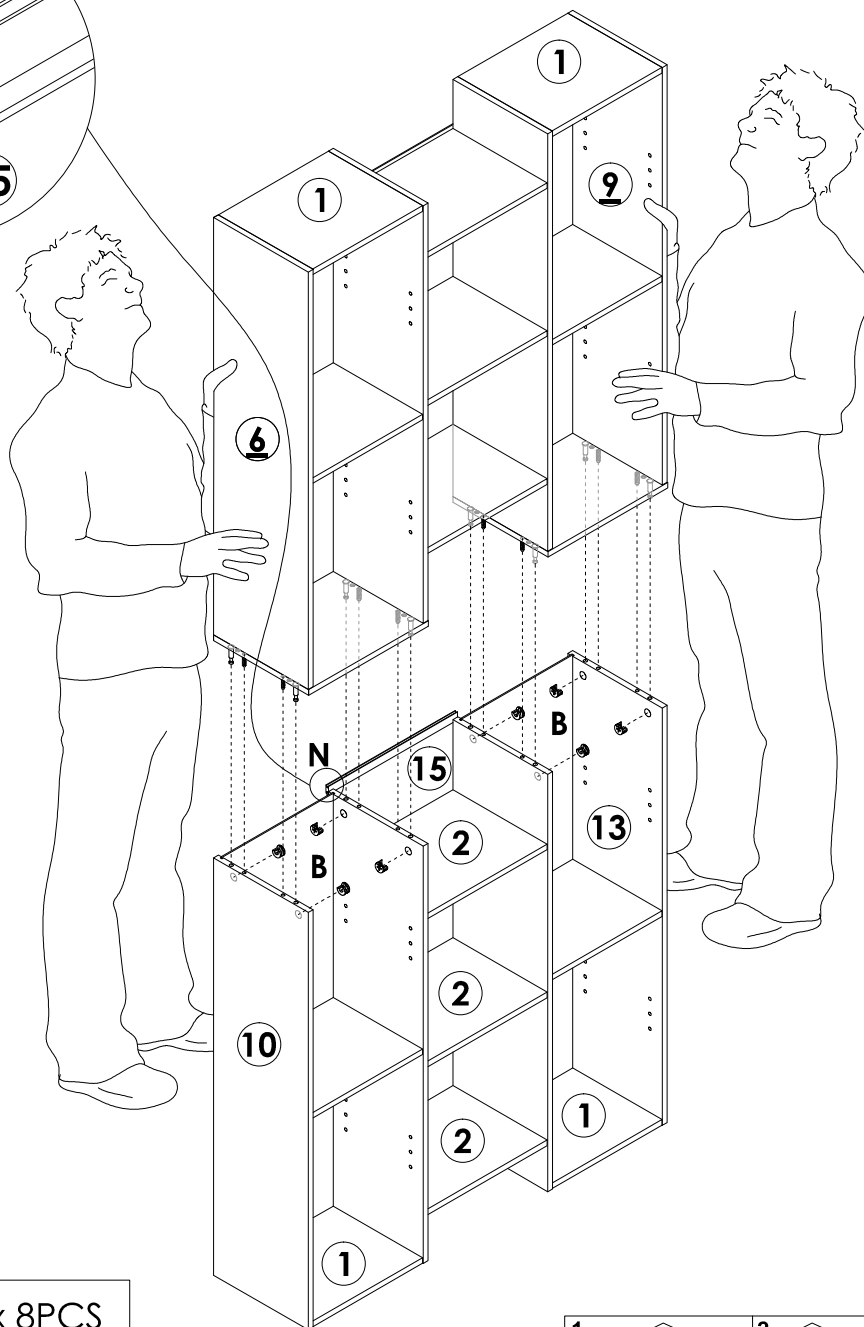
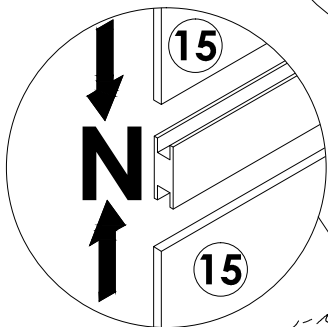
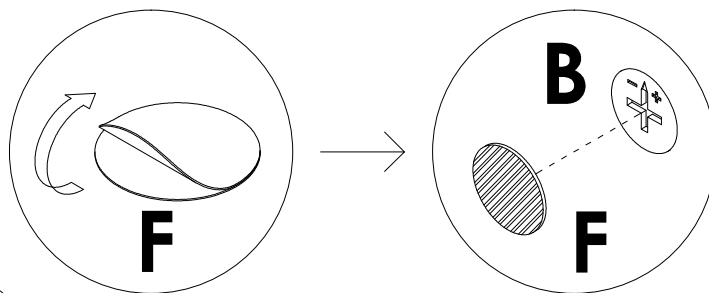

# Assembly Steps(EN) / Montageschritte(DE)

## STEP 18



	<b>B</b> x 8PCS
	<b>F</b> x 8PCS
	<b>N</b> x 1PC

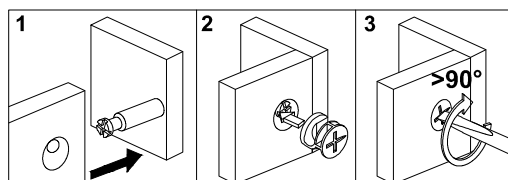

# STEP 19

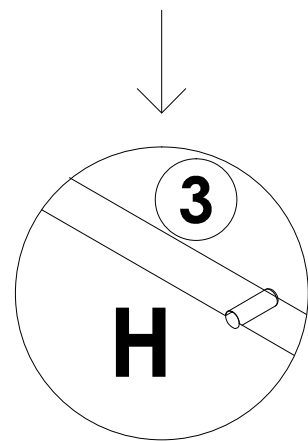
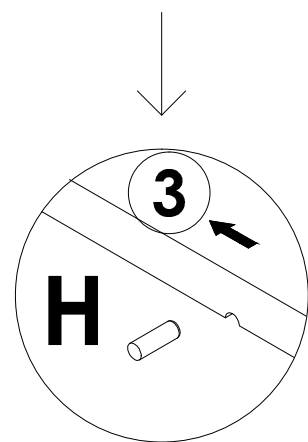
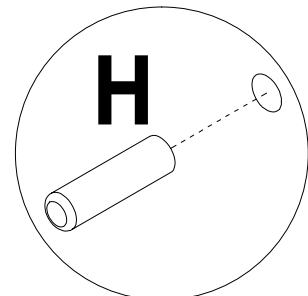
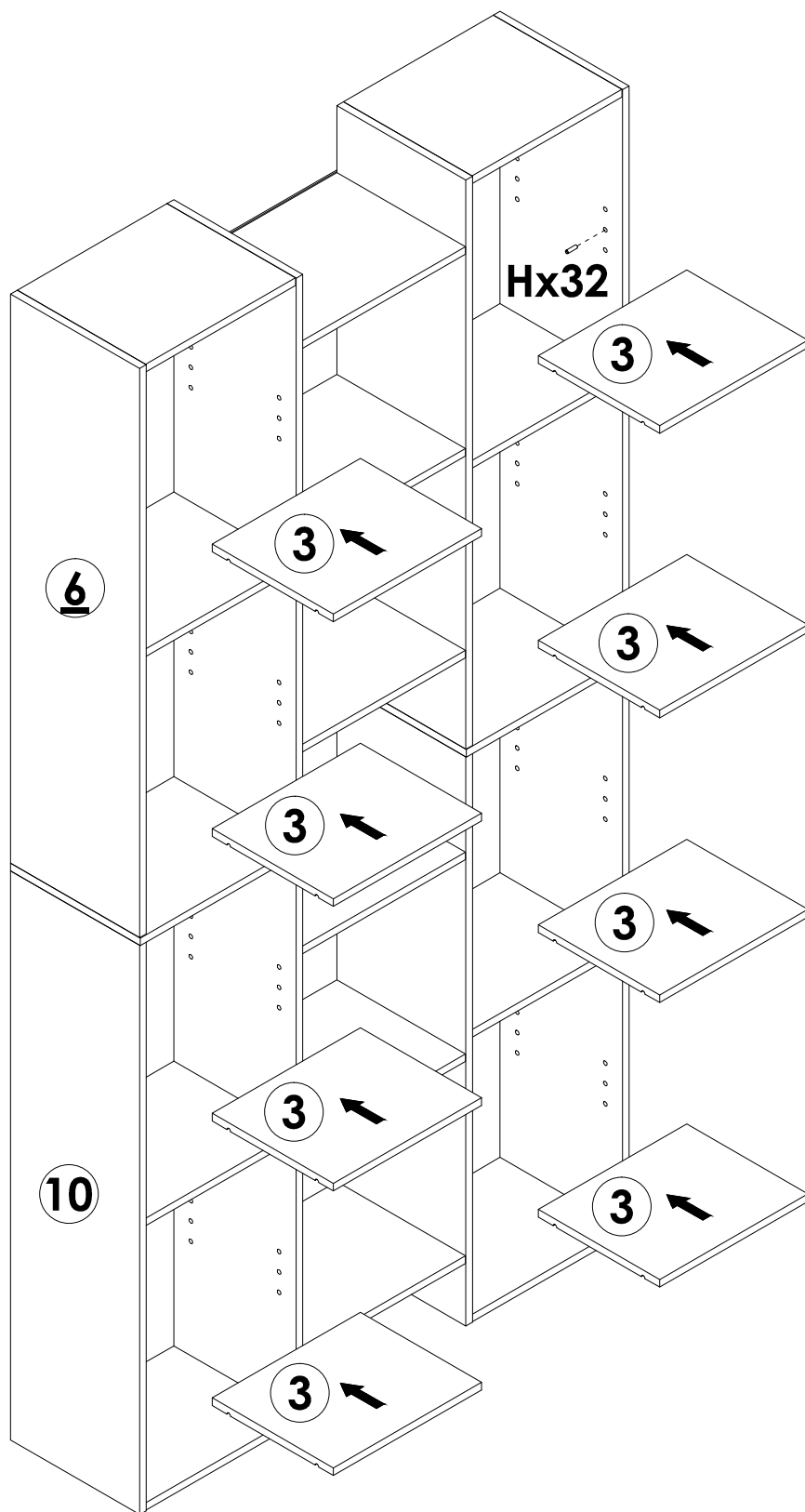





H x 32PCS

## Assembly Steps(EN) / Montageschritte(DE)

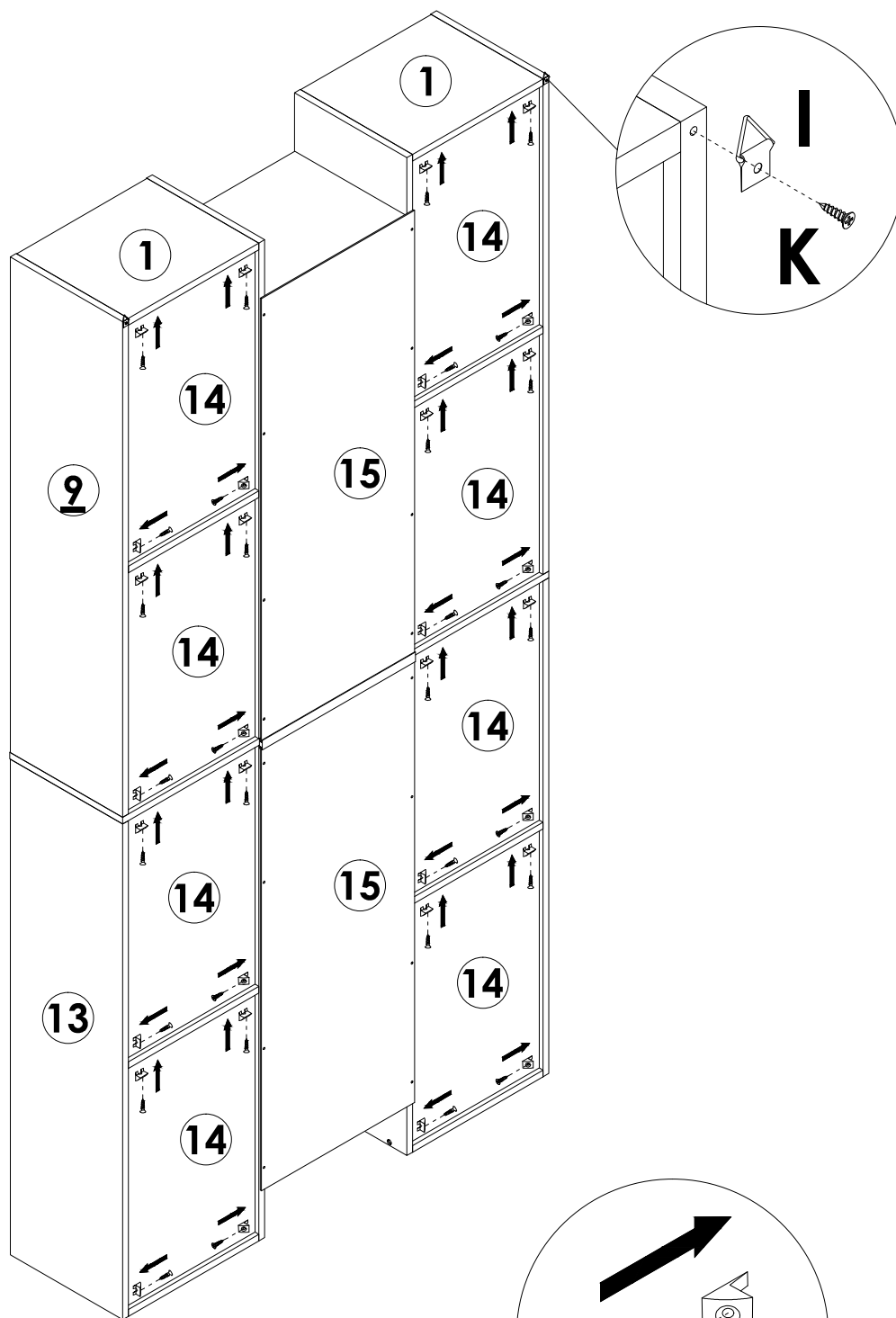
### STEP 20

Use the " K " screw to lock the " I " part on the back of the " ① and ② " board.



	I x 2PCS
	K x 34PCS
	J x 32PCS

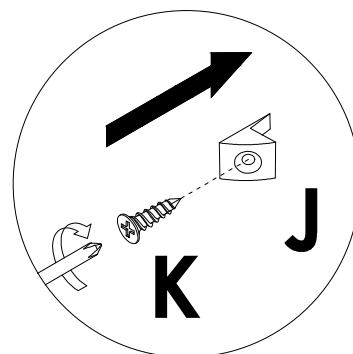



# Assembly Steps(EN) / Montageschritte(DE)

## STEP 21

Drill 2 holes on the wall at the required position for anti-falling device installation.

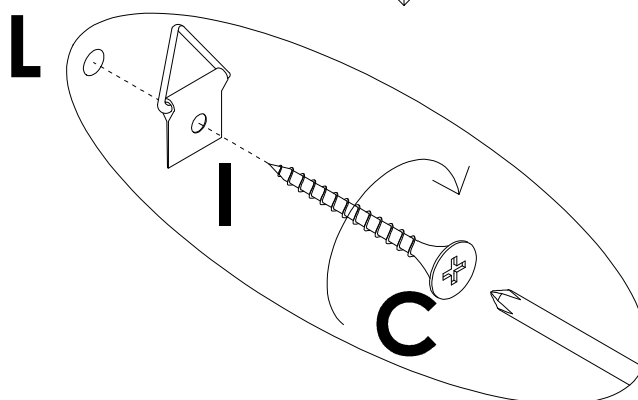
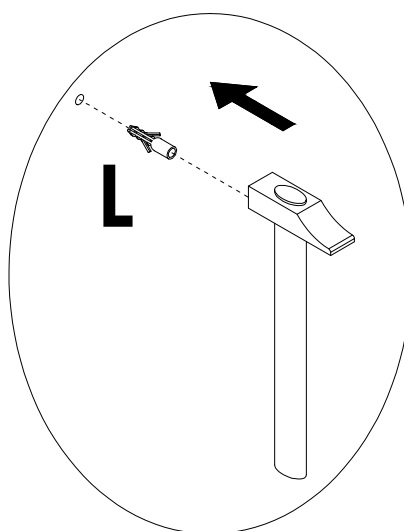
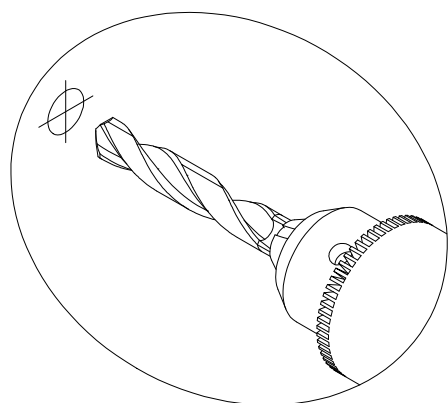
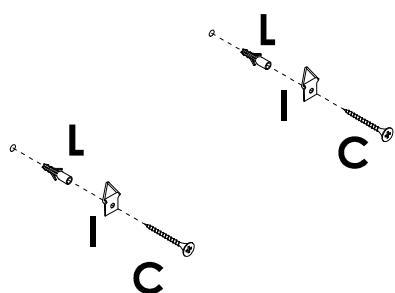
WALL

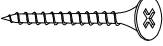

	<b>C</b> x 2PCS
	<b>I</b> x 2PCS
	<b>L</b> x 2PCS

## STEP 22

WALL

After that, move the cabinet to the corresponding position, then use the part " **M** " to pass through the part " **I** ", and tighten it. The installation of the anti-falling device is completed.

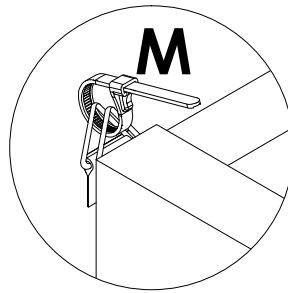
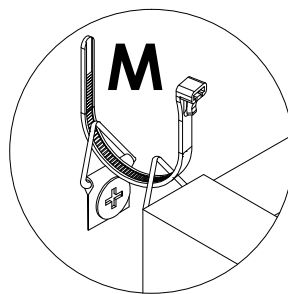
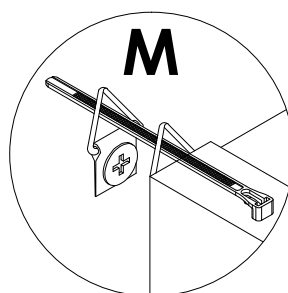
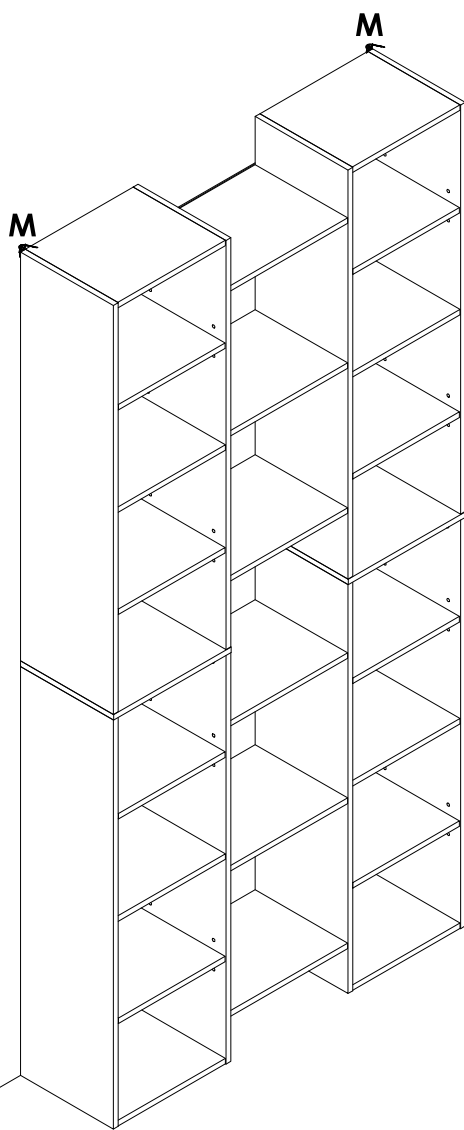

**M** x 2PCS



## WARNING



Children have died from furniture tipover. To reduce the risk of furniture tipover:

- **ALWAYS** install Anti-tip device provided.
- **NEVER** put a TV on this product.
- **NEVER** allow children to stand, climb or hang on drawers, doors, or shelves.
- **NEVER** open more than one drawer at a time.
- Place heaviest items in the lowest drawers.

