

INSTRUCTION MANUAL

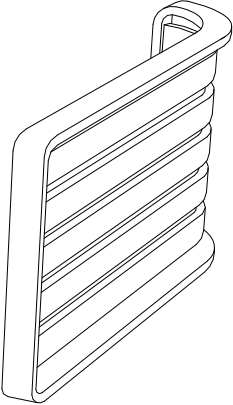
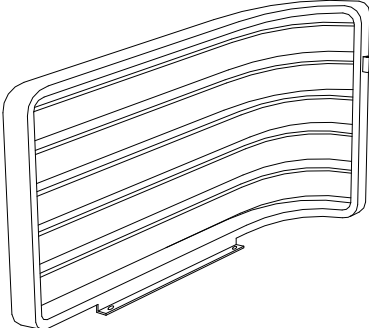
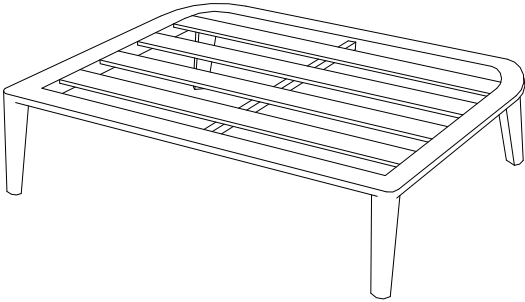
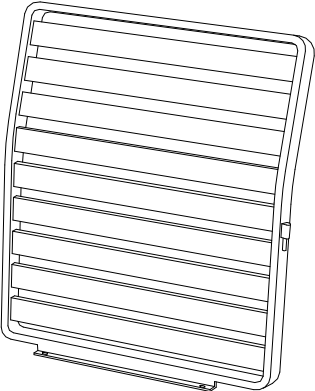

Hello! Please read these important attentions...

Please put a thick carpet on the ground to protect the furniture finish and corners. During the installation process, **DON' T** fasten screws tight 100% at a time.

Assembly Instructions

No.	COMPONENT	DESCRIPTION	QTY
A		LEFT ARMREST	1
B		RIGHT ARMREST	1
C		SEAT FRAME	1
D		BACK FRAME	1

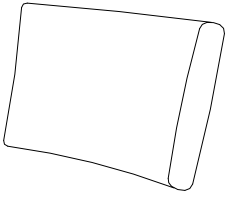
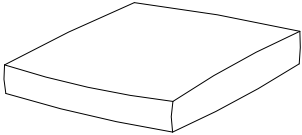
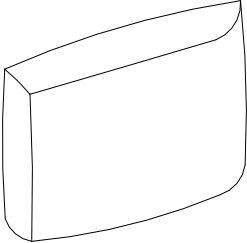
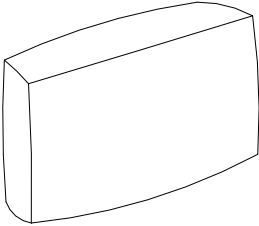
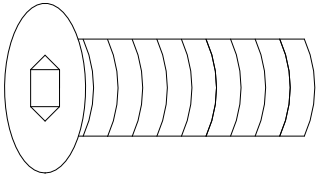
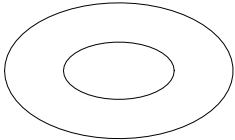
Assembly Instructions

No.	COMPONENT	DESCRIPTION	QTY
E		BACK CUSHION	1
F		SEAT CUSHION	1
G		LEFT ARMREST CUSHION	1
H		RIGHT ARMREST CUSHION	1
I		1/4" x 18 mm BOLT	6
J		Ø6.5 x 1.0 mm WASHER	6
K		HEX BOLT DRIVER	1

Assembly Instructions

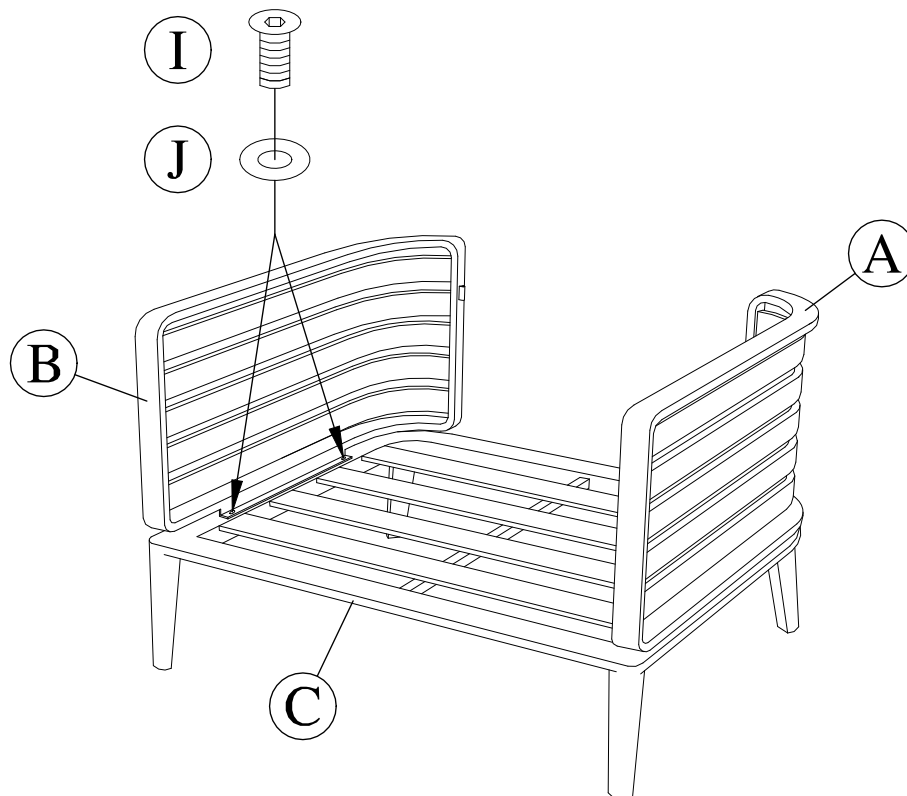
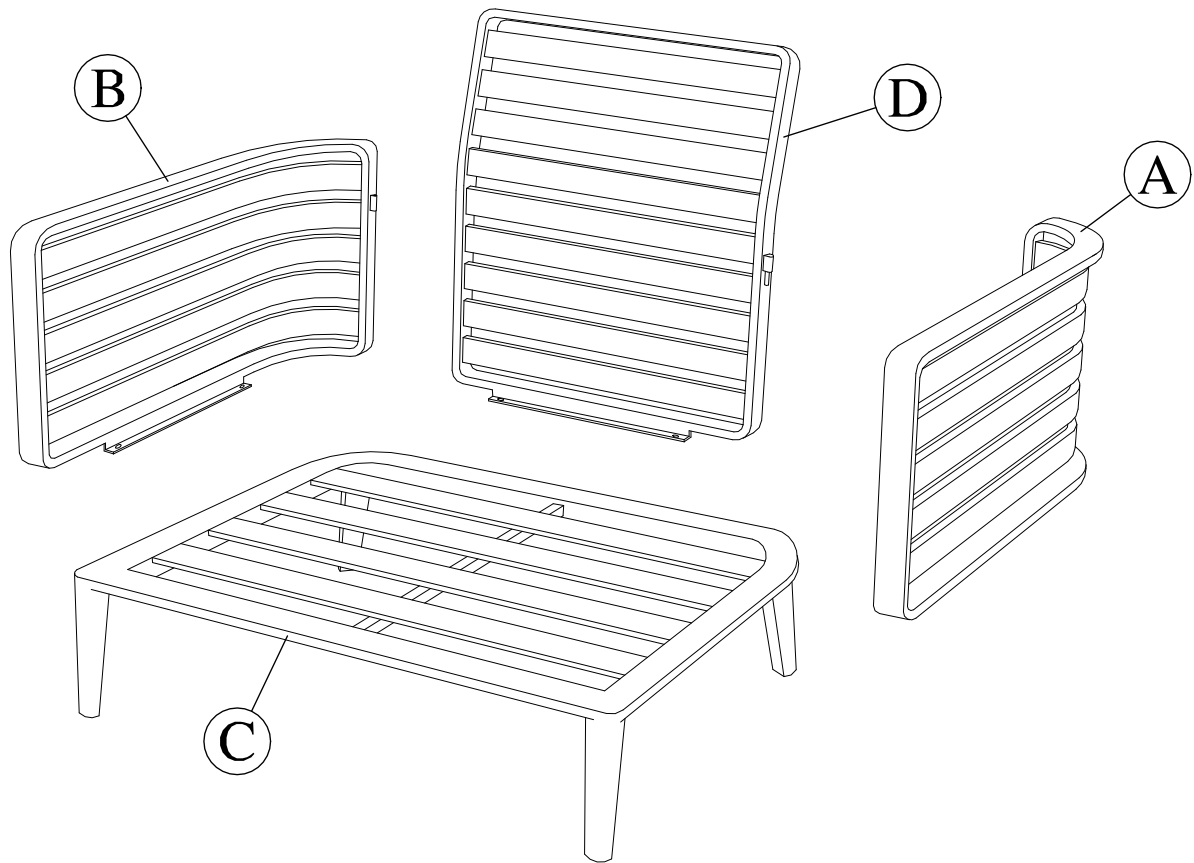

Step 1: Insert 1/4"x18mm bolt(I) and washer(J) through the holes in the left & right armrest(A&B) and the seat frame(C). Repeat for the rest holes in the frame.

Assembly Instructions

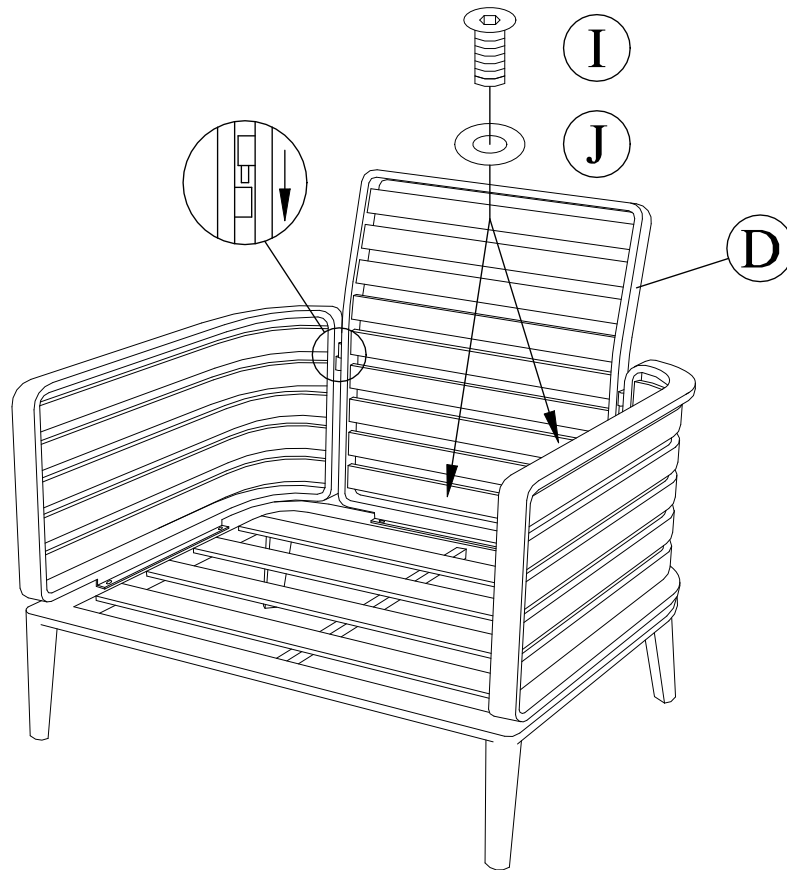

Step 2: Insert 1/4" x 18mm bolt (I) and washer (J) through the holes in the back frame (D) and the seat frame (C). Repeat for the rest holes in the frame.

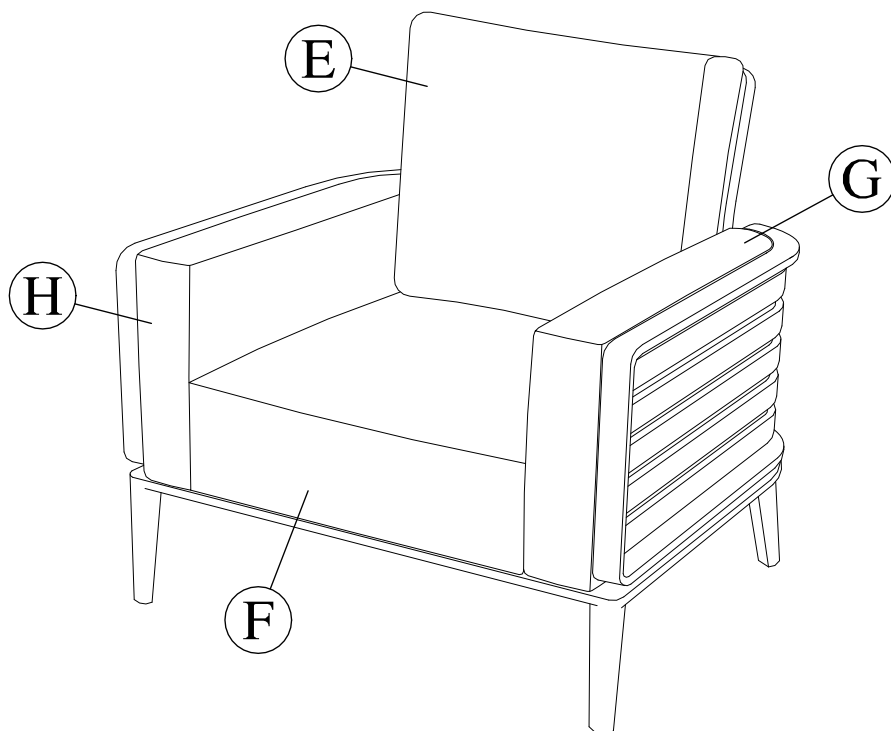

Step 3: Tighten all the bolts completely. Your chair should be ready for use.

FORM FOR REPLACING MISSING OR DAMAGED PIECES.

Model # of product: _____
Ordered by: _____
Ordered No: _____
Delivery date: _____

Were the boxes good when delivery to you Yes / No
Upon receiving the product, were all the parts intact Yes / No

Name: _____
Address: _____

Tel: _____

If the product is found damaged after assembly, please provide photo of the entire furniture set and all damaged areas.

Part#	Qty	Description	Missing/Damaged
			M / D
			M / D
			M / D
			M / D

Customer Instruction Card

To our most beloved and valued customer:

Thank you for your order, and we appreciate your trust and support.

If you need any assistance or have any questions about your order, please reach our customer service team with your order number at:

If you would like to know more about Direct Wicker or need to forward documents, you can also reach us

Our team will always be here to help.

Common Questions:

1. Normally the cushion is placed within the ottoman/ chair, please turn it upside down, you may find the cushion.
2. Please do not fully tighten the screws before all parts were assembled successfully, in case the products can not be lined up in position.
3. Furniture sets are mostly delivered in multiple cartons. If the numbers of boxes you received are not correct/missing. Please contact us via phone or email with your order number.
4. Our cushions are considered as shower proof, and we recommend that when the furniture set is not in use, cover it with a furniture cover or store it in dry place.
5. Always be careful when cleaning or handling glass (Always wear gloves and read the instructions of any household cleaner.) We do not advise placing hot objects such as tea or coffee pots directly onto the surface of the glass, always use coasters.
6. If you would like to return the order, be sure to also return any accessories and packing slips that came with your original package.
7. For all your accessory needs, please visit our brand's official website:
8. To preserve the longevity and beauty of your glass-topped wicker table, we recommend placing it in a shaded area away from direct sunlight. Additionally, please use a rain cover to protect it when not in use.

Thank you for your understanding and cooperation, we wish you a fantastic shopping experience with us, and we are looking forward to serving you again!

Direct Wicker Team



Your Home Our Passion

