

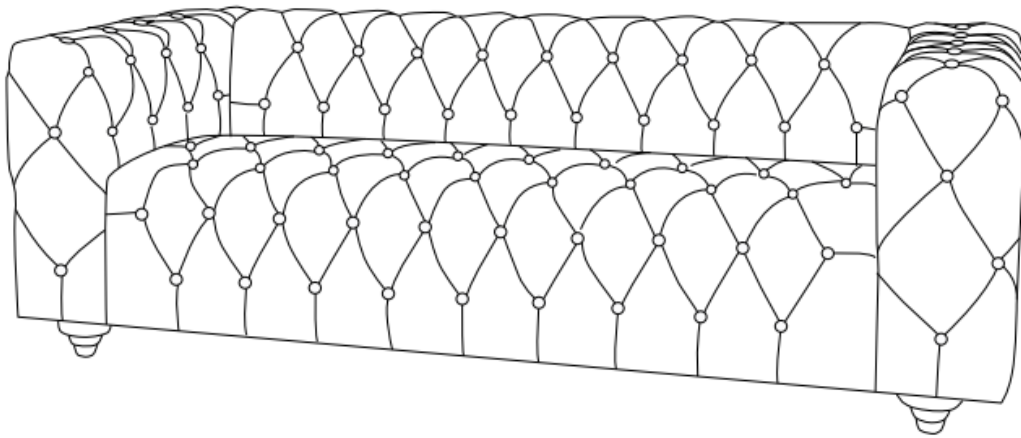

Assembly Instructions

Caution: You must read this before you proceed



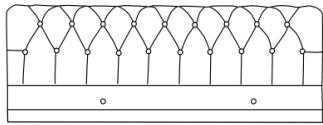
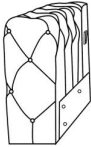
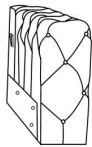
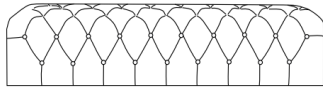

SOFA



Part List

Label	Picture	Description	QTY
A		Backrest	1
B		Left Armrest	1
C		Right Armrest	1
D		Seat	1
E		Leg	4

Hardware

Label	Picture	Description	QTY
①		Bolt (M8*60MM)	9
②		Flat Washer	9
③		Spring Washer	9
④		Allen Wrench	1
⑤		Plastic Washer	7

Assembly Preparation

Before Beginning
Assembly:

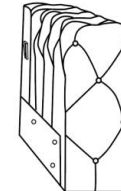
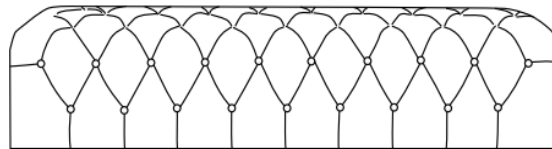
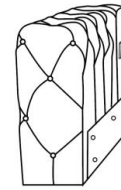
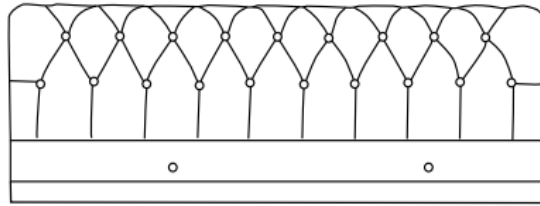

×9

×9

×9

×1

×7



- Read instructions, cover to cover-



- Have 2 adults on hand for assembly-



- Do not assemble on flooring or carpet-



- Assemble on a clean non-marring surface (packing foam)-



- Save all packaging until finished-

Assembly Steps

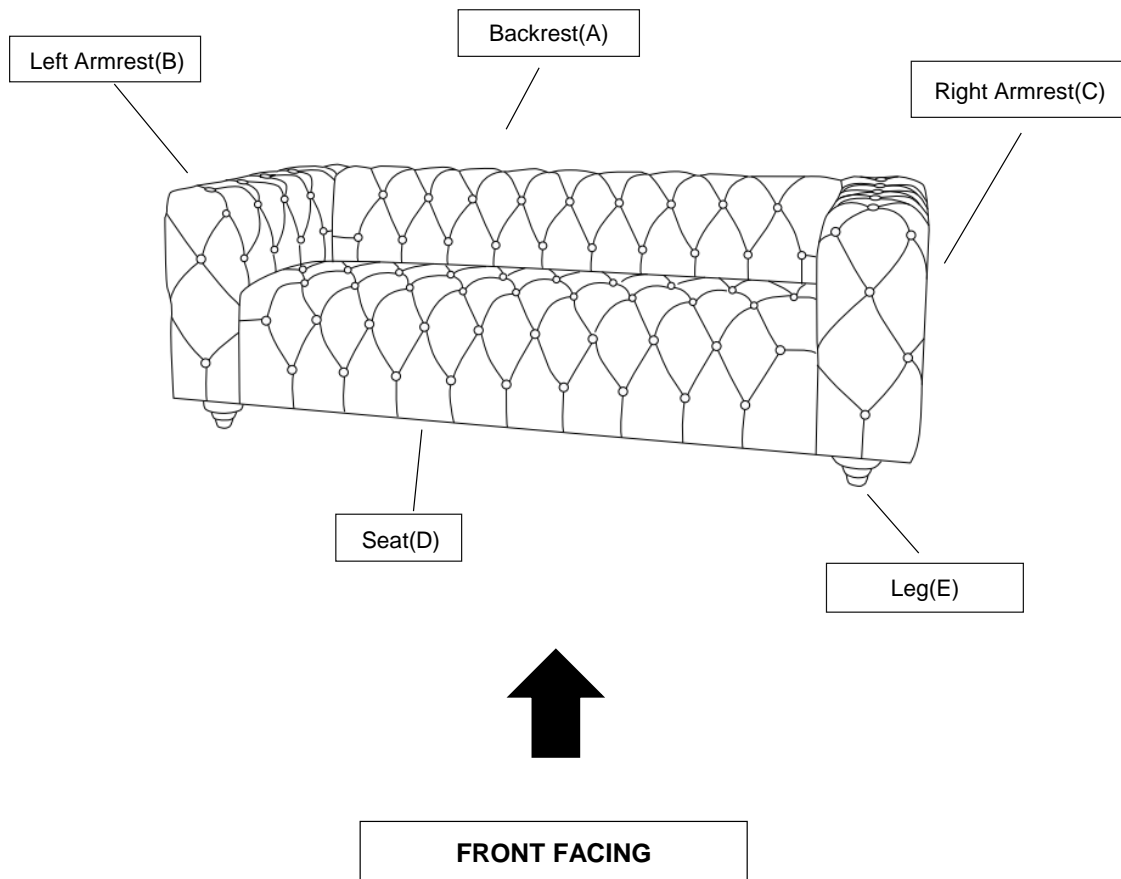

This Sofa has multiple parts and may require up to 60 minutes to assemble. To give you an overview of the Sofa parts, the above picture is to help you put the various parts into perspective. Please read through the instructions below to familiarise yourself with the parts and steps before assembly.

Note: It is recommended that you have an adult partner to assist during the entire assembly process.

Step 1

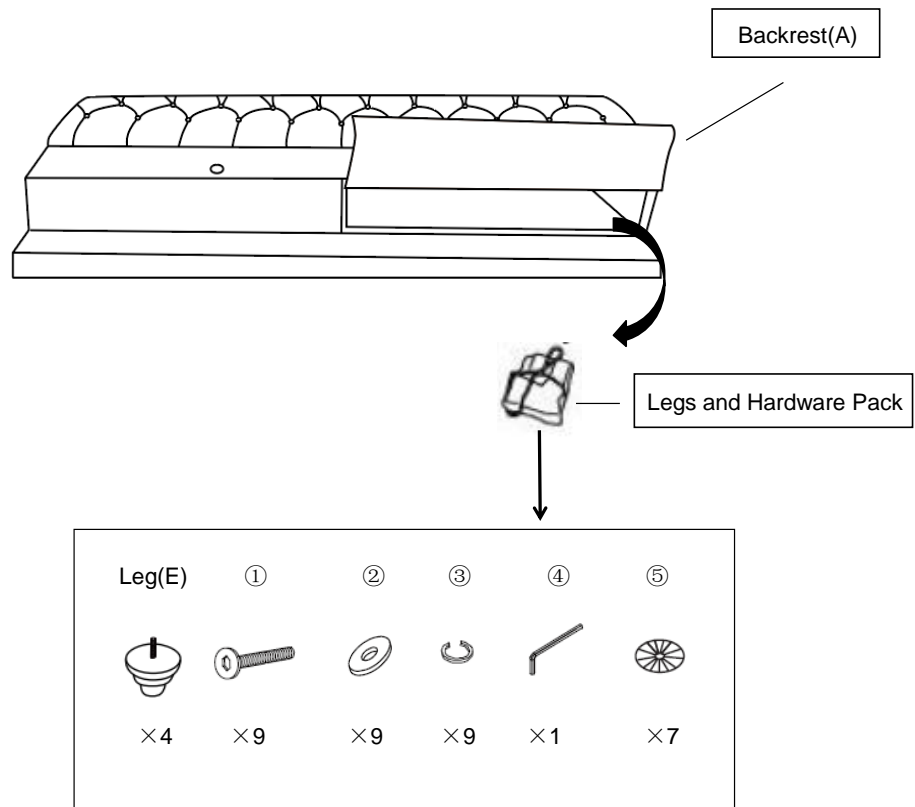

Open the magic tape on the bottom of the Backrest(A). Remove the Legs and Hardware Pack.

Step 2

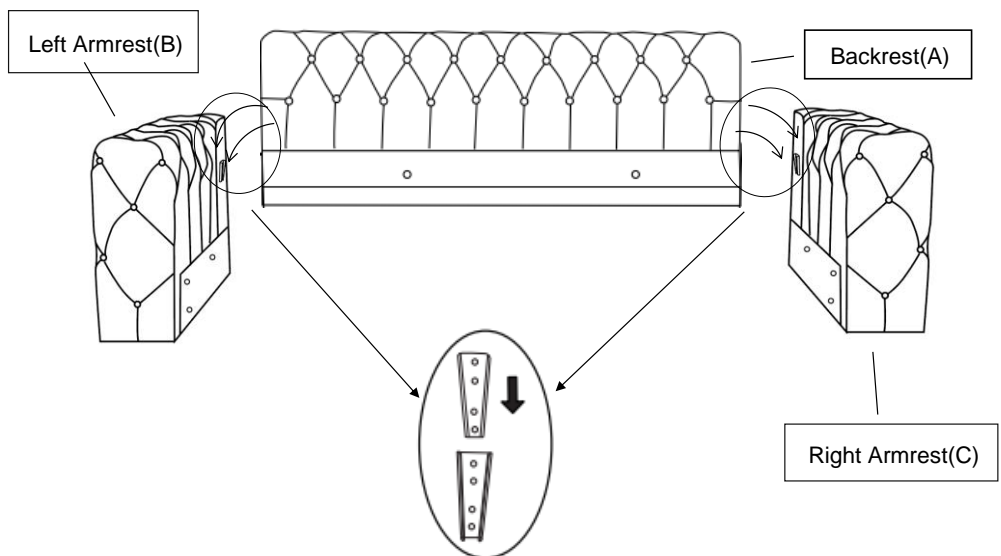

With the assistance of your partner, slide the Tapered Connectors on the Backrest(A) into the Tapered Connectors on the Left Armrest(B) as shown in the picture.
Repeat the same process with the Right Armrest(C).

Note: Make sure the Tapered Connectors on Left Armrest(B) and Right Armrest(C) lock into the Tapered Connectors on the Backrest(A).

Assistance from an adult partner is needed for this assembly process.

During this assembly process - do exercise caution. You may need to use your hand to press down or pave away the padded surface to facilitate the 'slip and slide' assembly.

Caution: Ensure that your fingers do not get caught or pinched in the assembly process.

Step 3

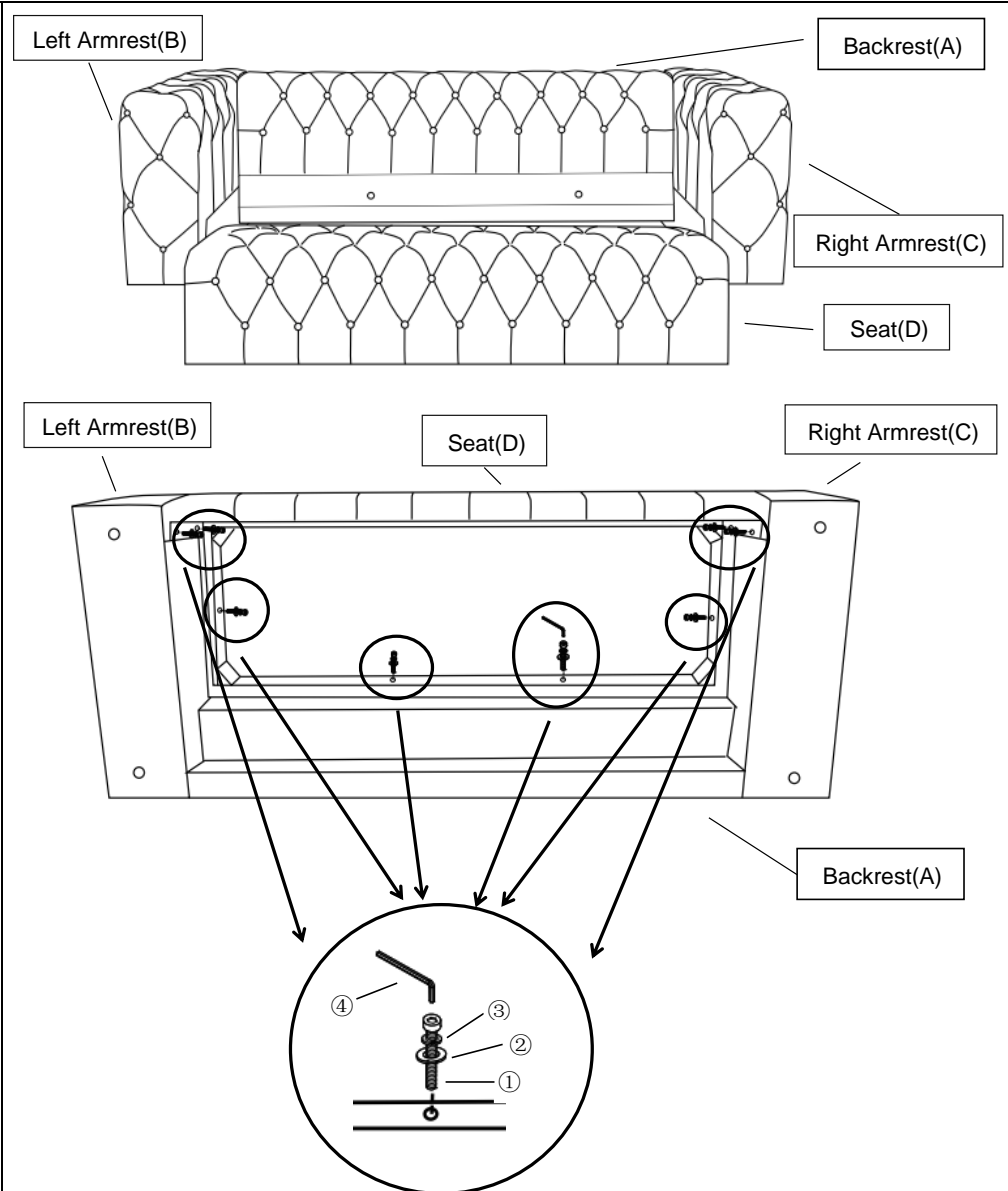

Place the Seat(D) between the two armrests and hold it close to the Backrest(A).
Tilt and lay the Sofa on its Backrest(A) onto a flat surface.
Attach the Backrest(A),Left Armrest(B),Right Armrest(C) to Seat(D) using Bolts(①), Flat Washers(②), and Spring Washers(③) with Allen Wrench(④).

DO NOT fully tighten a bolt in one go and then move on to the next.
Rather, In a sequential manner, gradually tighten each Bolt until all Bolts are evenly secured.
This methodology will ensure maximum evenness once all Bolts are fully tightened.

Step 4

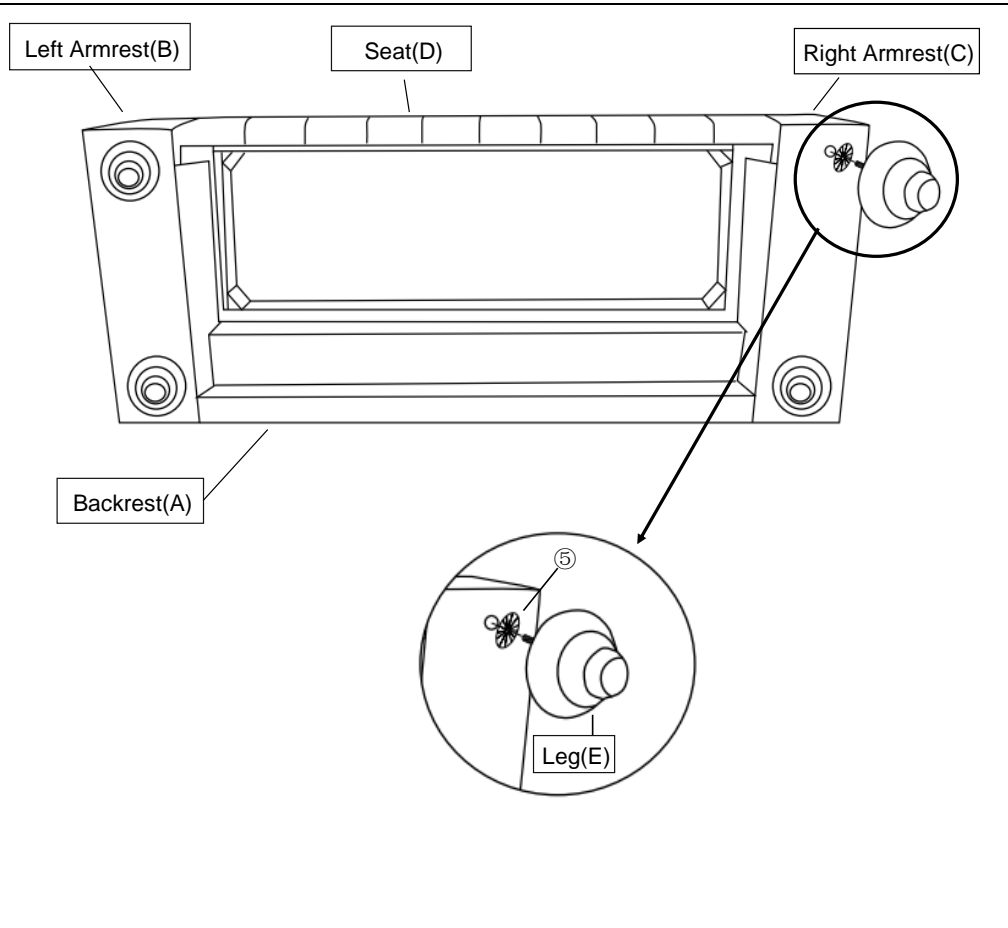

Install the Leg(E) at the bottom of the Sofa by placing one Plastic Washer(⑤) on the threaded stem.
Then insert threaded stem into the threaded mounting position at the corner of the Sofa.
Tighten by turning the Leg clockwise.
Repeat the same step to install the remaining three Legs.

Note: The use of Plastic Washers(⑤) are OPTIONAL and are especially useful to help alleviate slight wobbles. Some Legs may need more than one whilst some legs may not need any.

Step 5

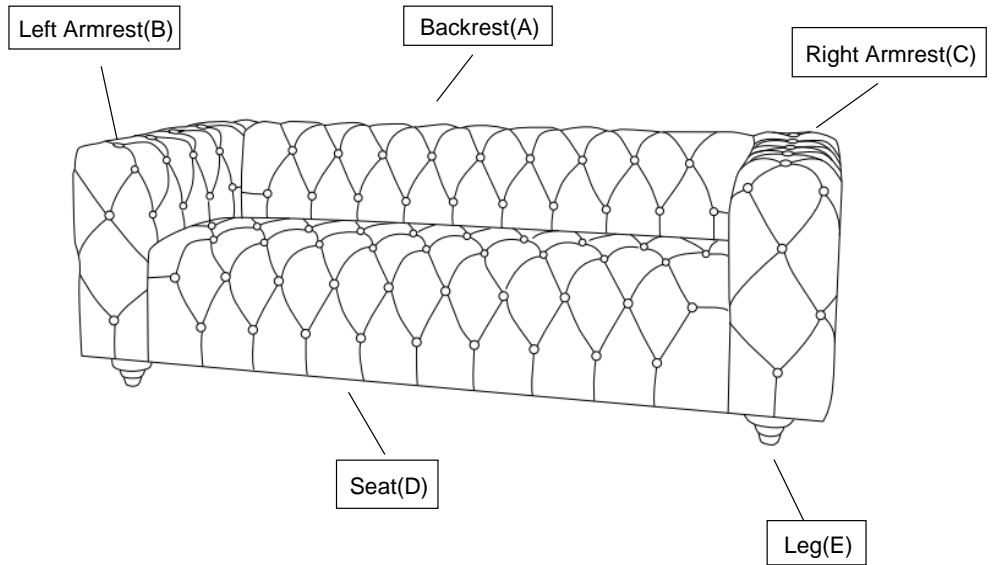

Lay the Sofa flat.

Step 6

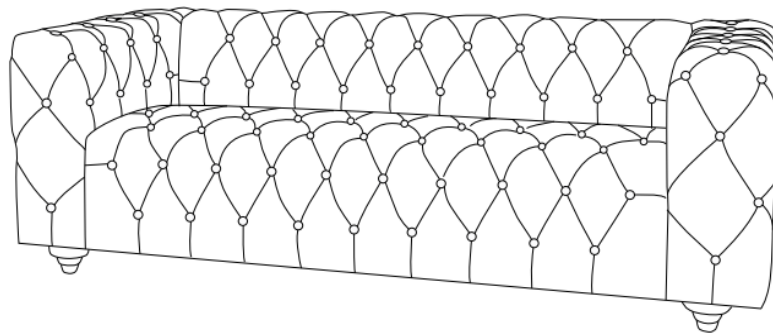

Your Sofa is ready for use.
This Sofa can only be used on a flat, level surface.

Care & Maintenance



- Furniture may scratch floors. We recommend using furniture pads to protect your floors.



- Do not put hot items directly on furniture surface.



- Do not clean furniture with harsh cleansers or polish.



- Do not place furniture under direct sunlight.



- Do not place furniture near heating or cooling vents.



- Do not write on furniture without a padded barrier to protect the surface.



- Do not place furniture outside . For indoor use only.



- Not for commercial use. For residential use only.



- Stains may be removed with mild soap solution and damp cloth.



- Children should not climb or jump on the furniture.



- Dust and pick-up spills using a clean, non-colored, lint-free cloth.