

ASSEMBLY INSTRUCTIONS



COUNTER HEIGHT STOOL

ASSEMBLY TIPS:

1. Remove hardware from box and sort by size.
2. Please check to see that all hardware and parts are present prior to start of assembly.
3. Please follow attached instructions in the same sequence as numbered to assure fast & easy assembly.



WARNING!

1. Don't attempt to repair or modify parts that are broken or defective. Please contact the store immediately.
2. This product is for home use only and not intended for commercial establishments.

ASSEMBLY TIME

5 MINUTES

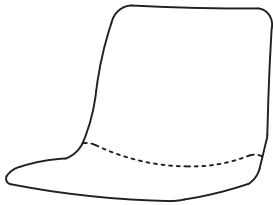

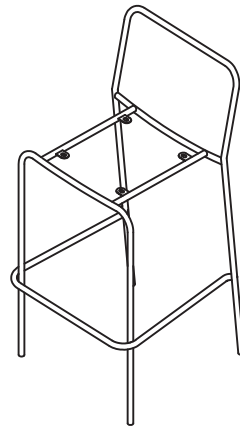

A SEAT AND BACK 1PC



B BASE 1PC

HARDWARE IDENTIFICATION

Z	HARDWARE NAME	FIGURE	QTY
1	BOLT	 M6*16	4PCS
2	FLAT WASHER		4PCS
3	ALLEN WRENCH	 M5	1PC

ASSEMBLY INSTRUCTIONS

STEP 1

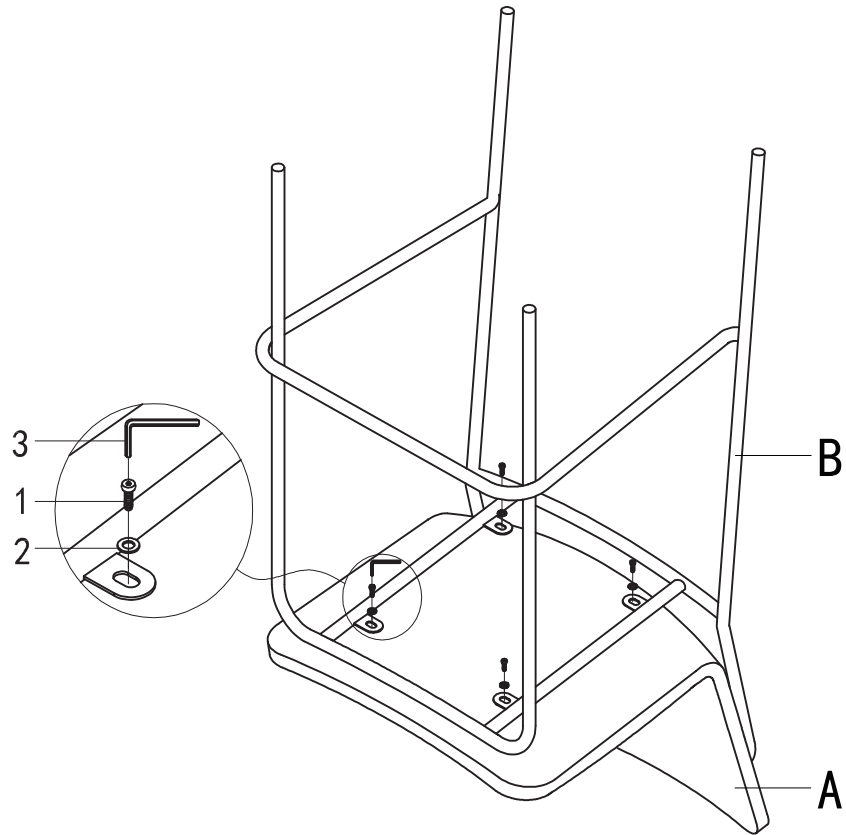

STEP 2

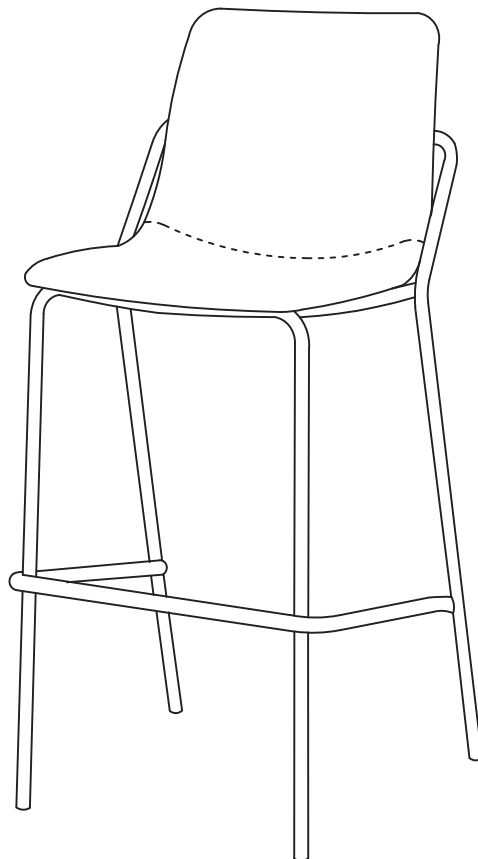

ASSEMBLY INSTRUCTIONS

