

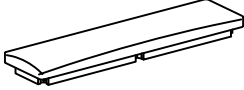

ASSEMBLY INSTRUCTIONS



Thank you for purchasing this quality product . Be sure to check all packaging material carefully for small parts that may have come loose inside the carton during shipment .

"Hardware is attached underneath the seat bottom"

Components List :

- | | | |
|-------------------|---|------|
| A. Bench Seat |  | 1pc |
| B. Chair Leg |  | 4pcs |
| C. Reinforced Leg |  | 2pcs |

Hardware List :

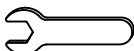
- | | | |
|---|--|-------|
| 1. Flat Washer $\phi 19 \times 5/16"$ |  | 12pcs |
| 2. Spring Washer $\phi 13 \times 5/16"$ |  | 12pcs |
| 3. Hex-Nut $5/16"$ |  | 12pcs |
| 4. Wrench $12 \times 75 \text{mm}$ |  | 1pc |

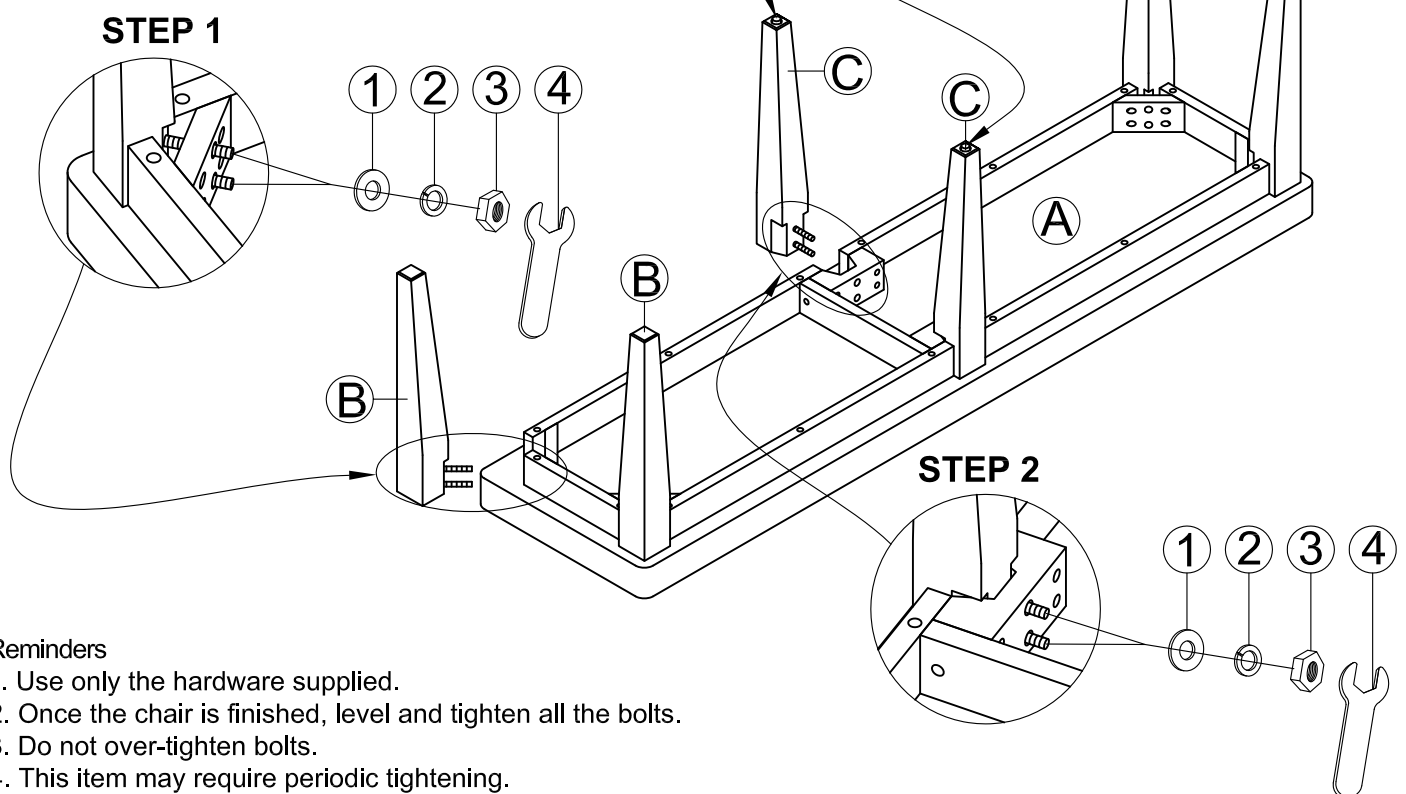
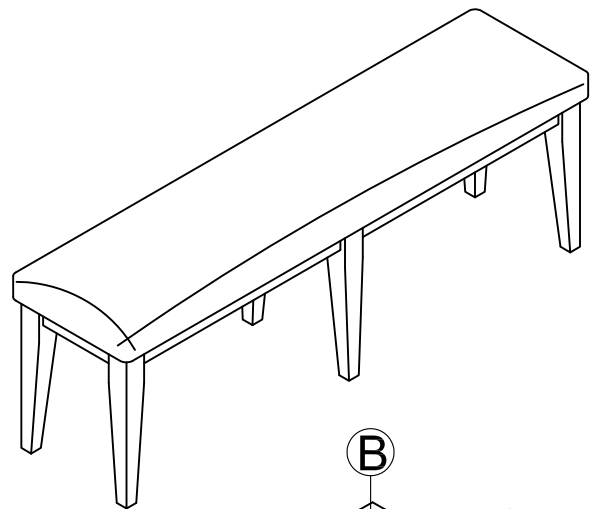

Reminders

1. Use only the hardware supplied.
2. Once the chair is finished, level and tighten all the bolts.
3. Do not over-tighten bolts.
4. This item may require periodic tightening.

Step1: Place the Bench Seat (A) up side down on the floor with a piece of cloth or carpet underneath to prevent the finish from scratching . Attach the Chair leg (B) to the Bench Seat (A) and secure with Flat washer (1), Spring washer (2) and Hex-nut (3). Tighten Hex-nut (3) with Wrench (4). Repeat this step for the remaining three legs.

Step2: Attach the Reinforced Leg (C) to the Bench Seat (A) and secure with Flat washer (1), Spring washer (2) and Hex-nut (3). Tighten Hex-nut (3) with Wrench (4). Repeat this step for the remaining that Reinforced Leg.

Assembly is now complete

Thank you for choosing this product.