

- 9571091WCOM (American Cherry)
- 9571220WCOM (Raven Oak)



# End Table

Date of Purchase \_\_\_ / \_\_\_ / \_\_\_  
 Lot Number:

B349571000WCOM0

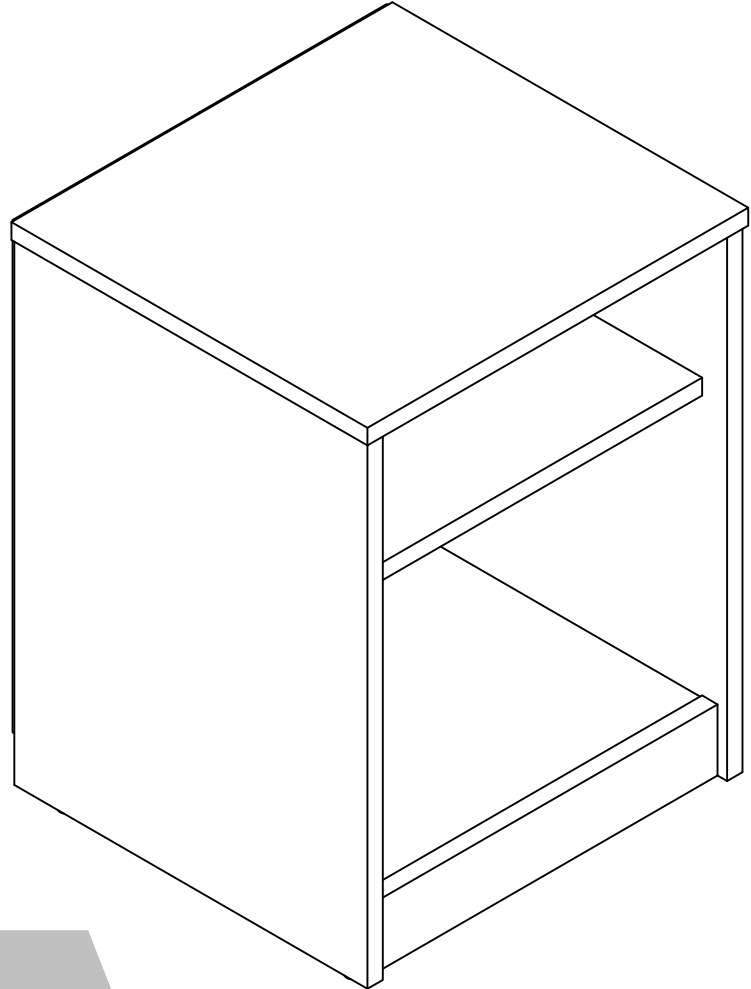

THIS INSTRUCTION BOOKLET CONTAINS **IMPORTANT** SAFETY INFORMATION. PLEASE READ AND KEEP FOR FUTURE REFERENCE.

### Do Not Return This Product!

Contact our customer service team for help first.

**Call:** 1-800-489-3351 (toll free)

Monday-Friday 9am - 5pm CST

**Visit:** [www.ameriwoodhome.com](http://www.ameriwoodhome.com)



## **WARNING**

- Unit can tip over causing severe injury or death.
- Anchor unit to stud in wall (if instructed to).
- Do Not allow children to climb on unit.
- Put heavy items on lower shelves or drawers.

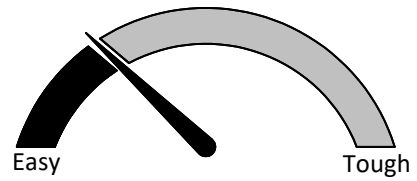

Assembly Difficulty Meter

Follow Ameriwood Home



## Contact Us!

### Do NOT return this product!

Contact our friendly customer service team first for help.

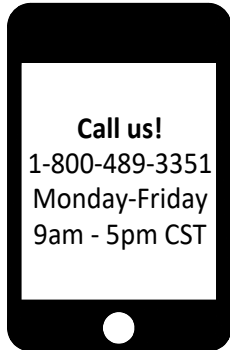

Visit [ameriwoodhome.com](http://ameriwoodhome.com) to view the limited warranty valid in the U.S. and Canada.

Assembly Tips



## Helpful Hints

PEOPLE NEEDED FOR ASSEMBLY: **1**

ESTIMATED ASSEMBLY TIME: **1 HOUR**

- Open your item in the area you plan to keep it to avoid excessive heavy lifting.
- Identify, sort and count the parts before attempting assembly.
- Compression dowels are lightly tapped in with a hammer.
- Slides are labeled with a **R** (right) and **L** (left) for proper placement.
- Make sure to always face the point on the top of the Cam Lock towards the outer edge.
- Use all the nails provided for the back panel and spread them out equally.
- Back panel must be used to make sure your unit is sturdy.
- Do NOT use harsh chemicals or abrasive cleaners on this item.
- Never push, pull, or drag your furniture.



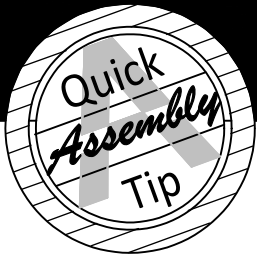

## Before You Start

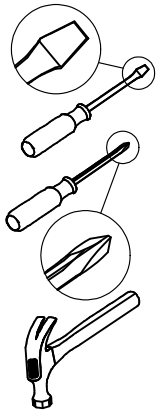

- ✓ Read through each step carefully and follow the proper order
- ✓ Separate and count all your parts and hardware  
Parts are labeled on the surface or edge of the part
- ✓ Give yourself enough room for the assembly process
- ✓ Have the following tools: Flat Head Screwdriver, #2 Phillips Head Screwdriver and Hammer
- ✓ Caution: If using a power drill or power screwdriver for screwing, please be aware to slow down and stop when screw is tight. Failure to do so may result in stripping the screw.

## Cam Lock Fastening System

This Cam Lock Fastening System will be used throughout the assembly process.

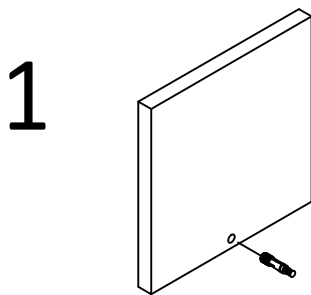

1 Press CAM BOLT into hole.

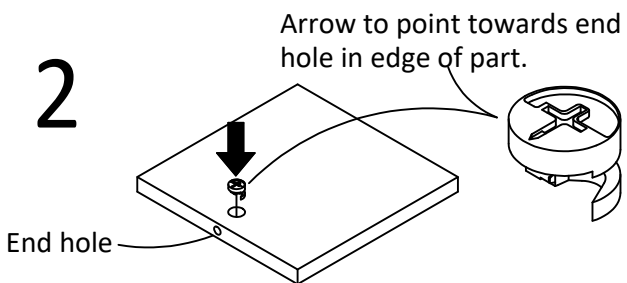

2 Press CAM LOCK into hole.

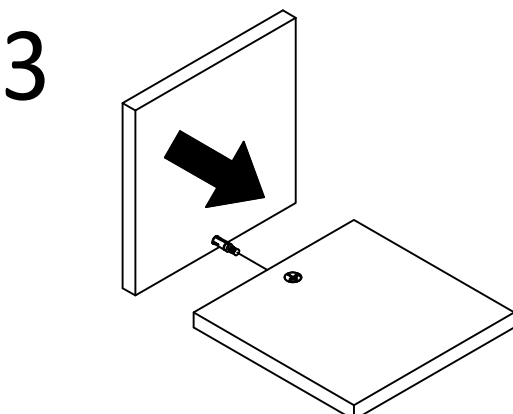

3 Press parts together so CAM BOLT inserts into edge hole.

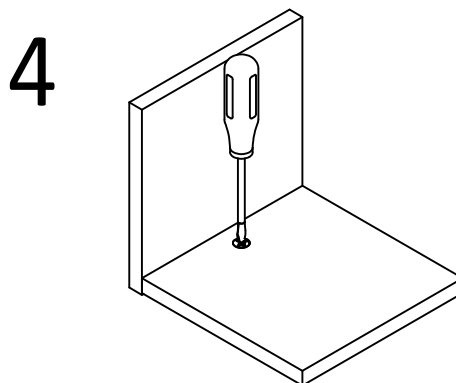

4 Using a screwdriver, turn the CAM LOCK clockwise to lock the CAM LOCK and CAM BOLT into their holes and fastening parts together.

# Board Identification

## 9571091WCOM (American Cherry) Parts List

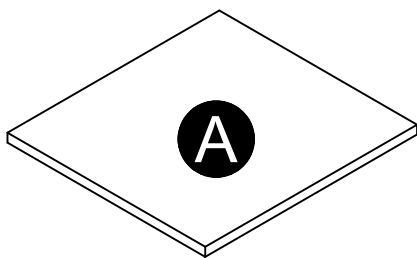

Top  
39571091010

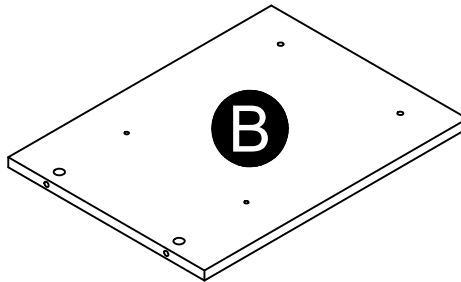

Side Panel  
39571091020

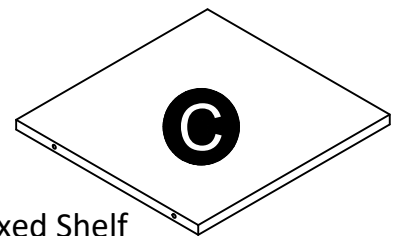

Fixed Shelf  
39571091030

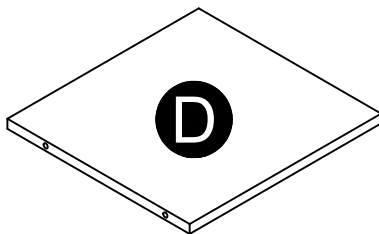

Bottom  
39571091040

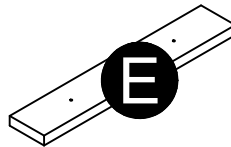

Kick  
39571091050

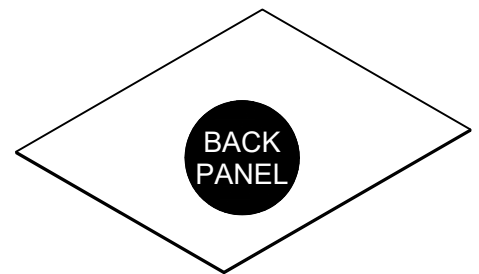

Back Panel  
K957109100

## 9571220WCOM (Raven Oak) Parts List

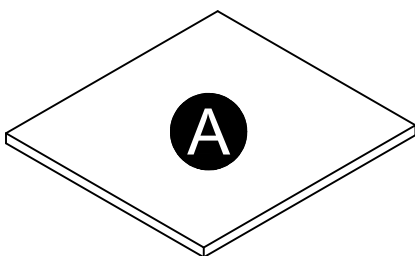

Top  
39571220010

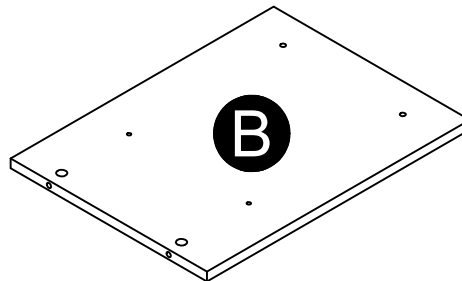

Side Panel  
39571220020

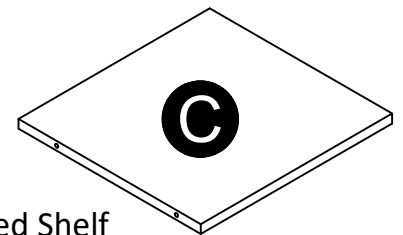

Fixed Shelf  
39571220030

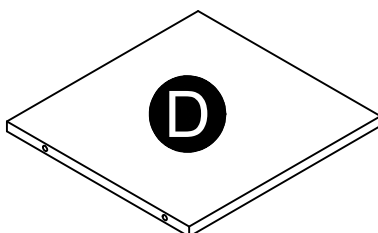

Bottom  
39571220040

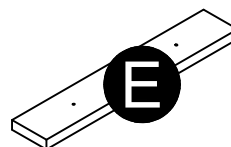

Kick  
39571220050

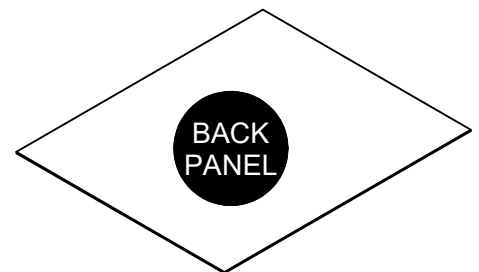

Back Panel  
K957122000

# Board Identification

Not actual size

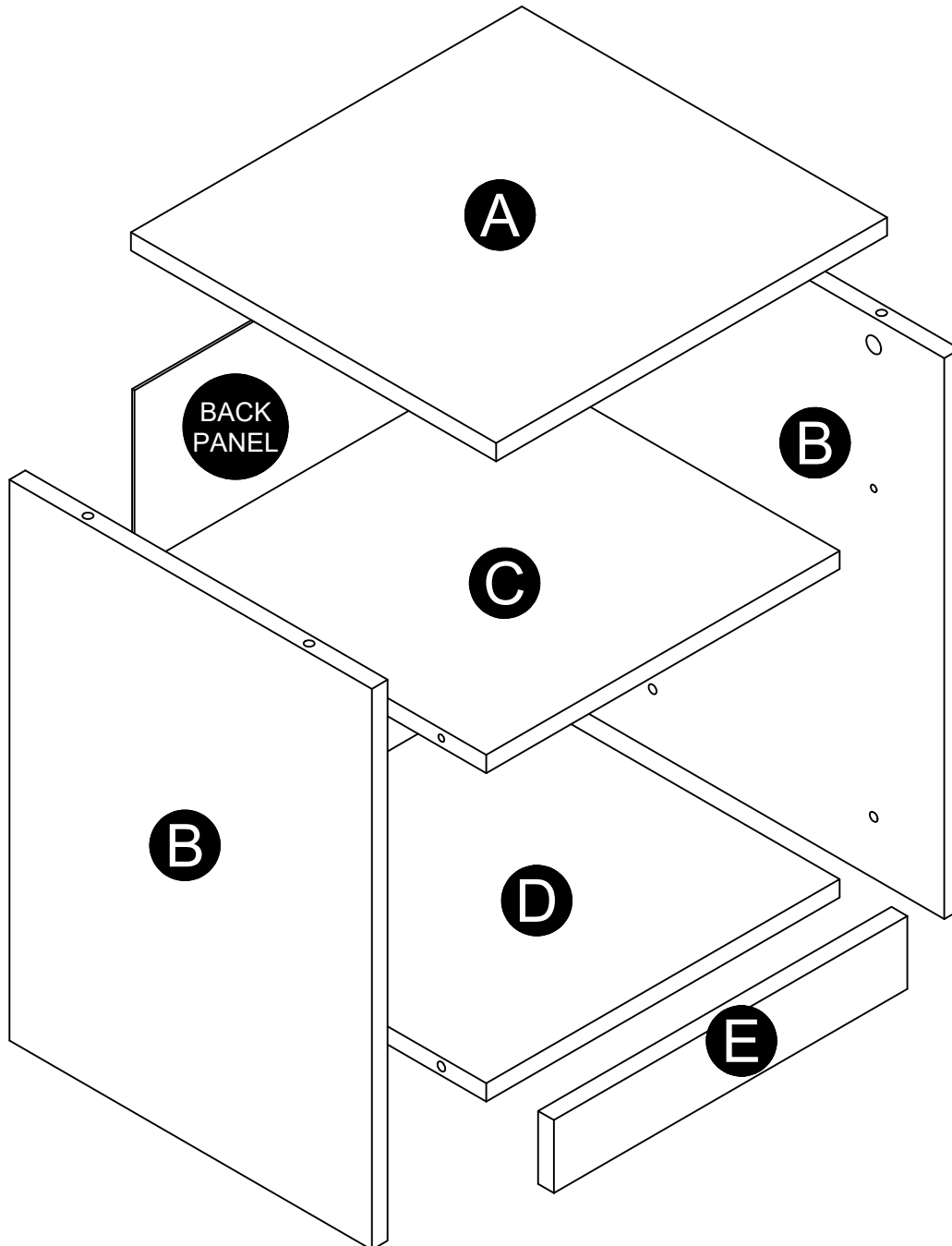

# Part List

Actual Size

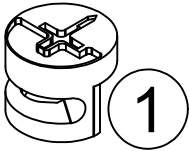

(x8)  
#A22700  
cam lock

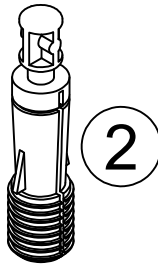

(x8)  
#A22710  
cam bolt

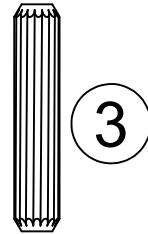

(x4)  
#A21660  
wood dowel

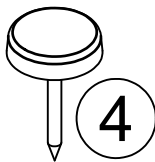

(x4)  
#A43200  
tack glide

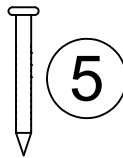

(x20)  
#A21110  
nail

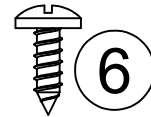

(x4)  
#A12105  
7/16" screw

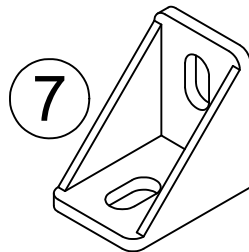

(x2)  
#A53510  
angle bracket

# STEP 1

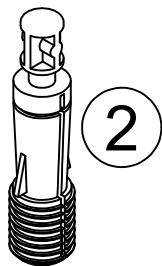

(x4)  
#A22710

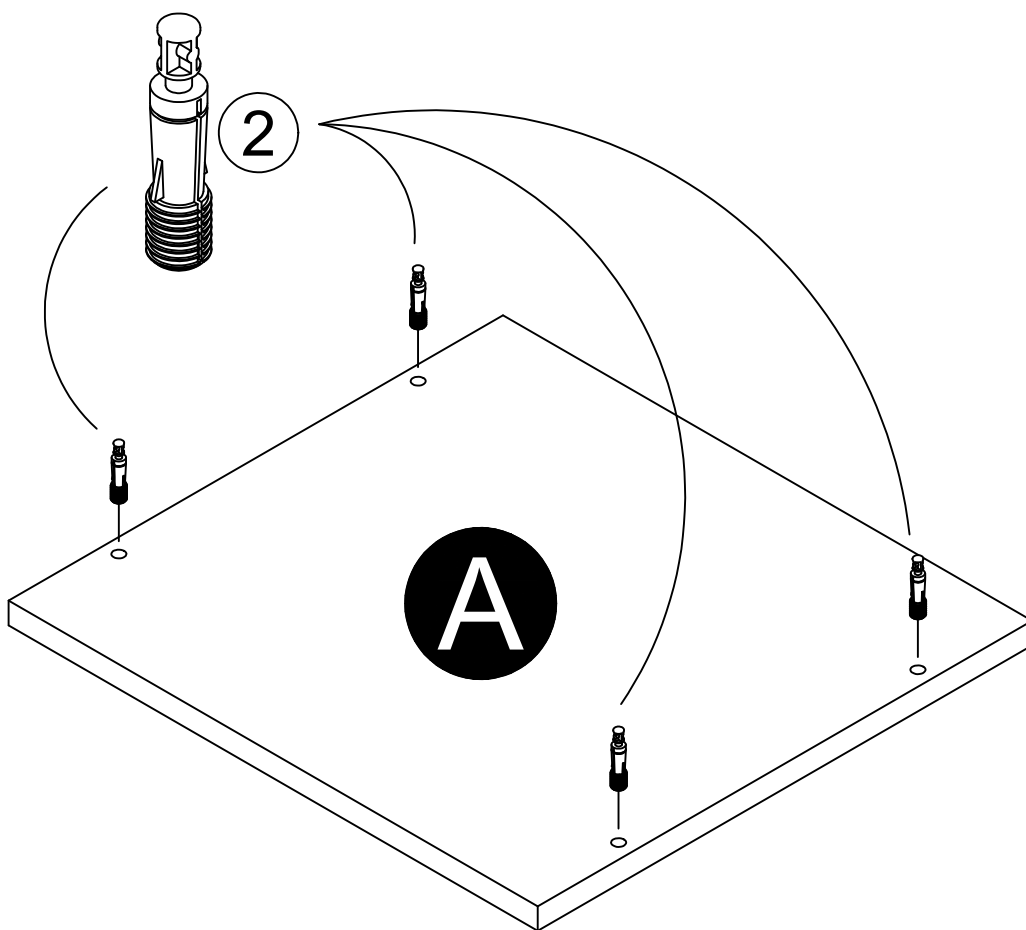
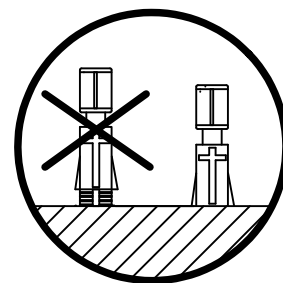

## STEP 2

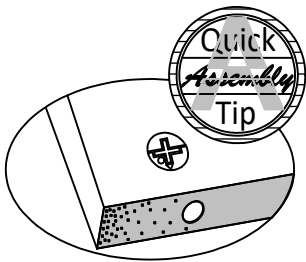
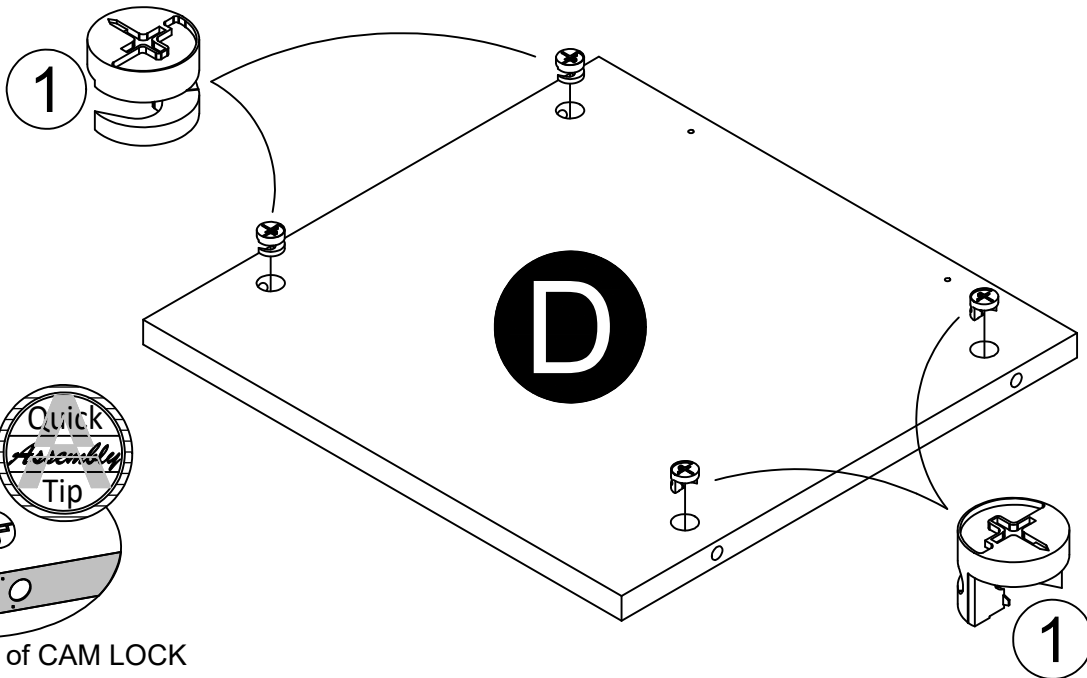
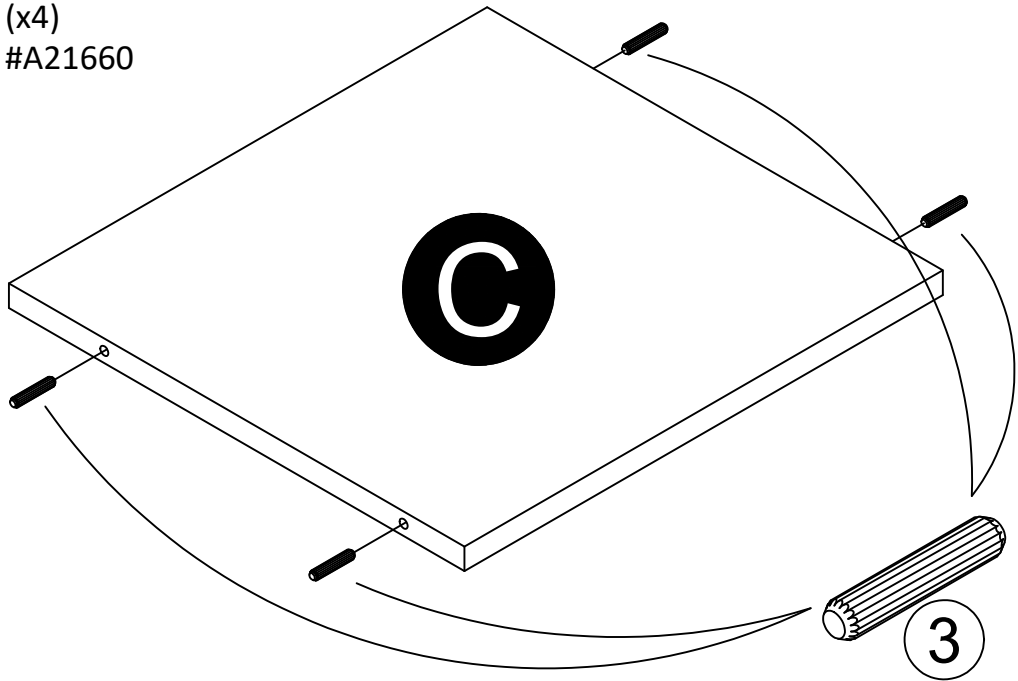
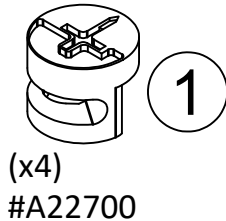
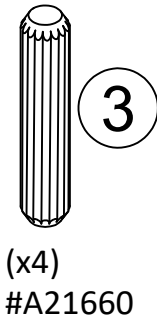
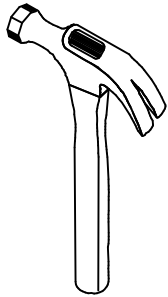

Proper orientation of CAM LOCK

## STEP 3

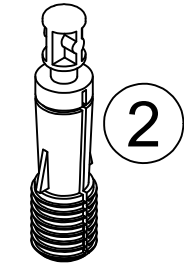

(x4)  
#A22710

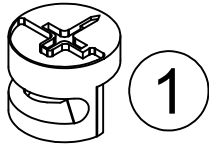

(x4)  
#A22700

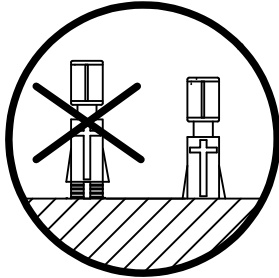

**x2**

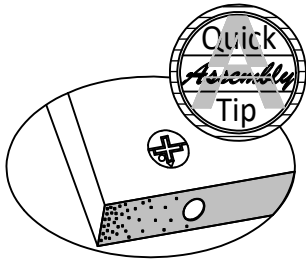
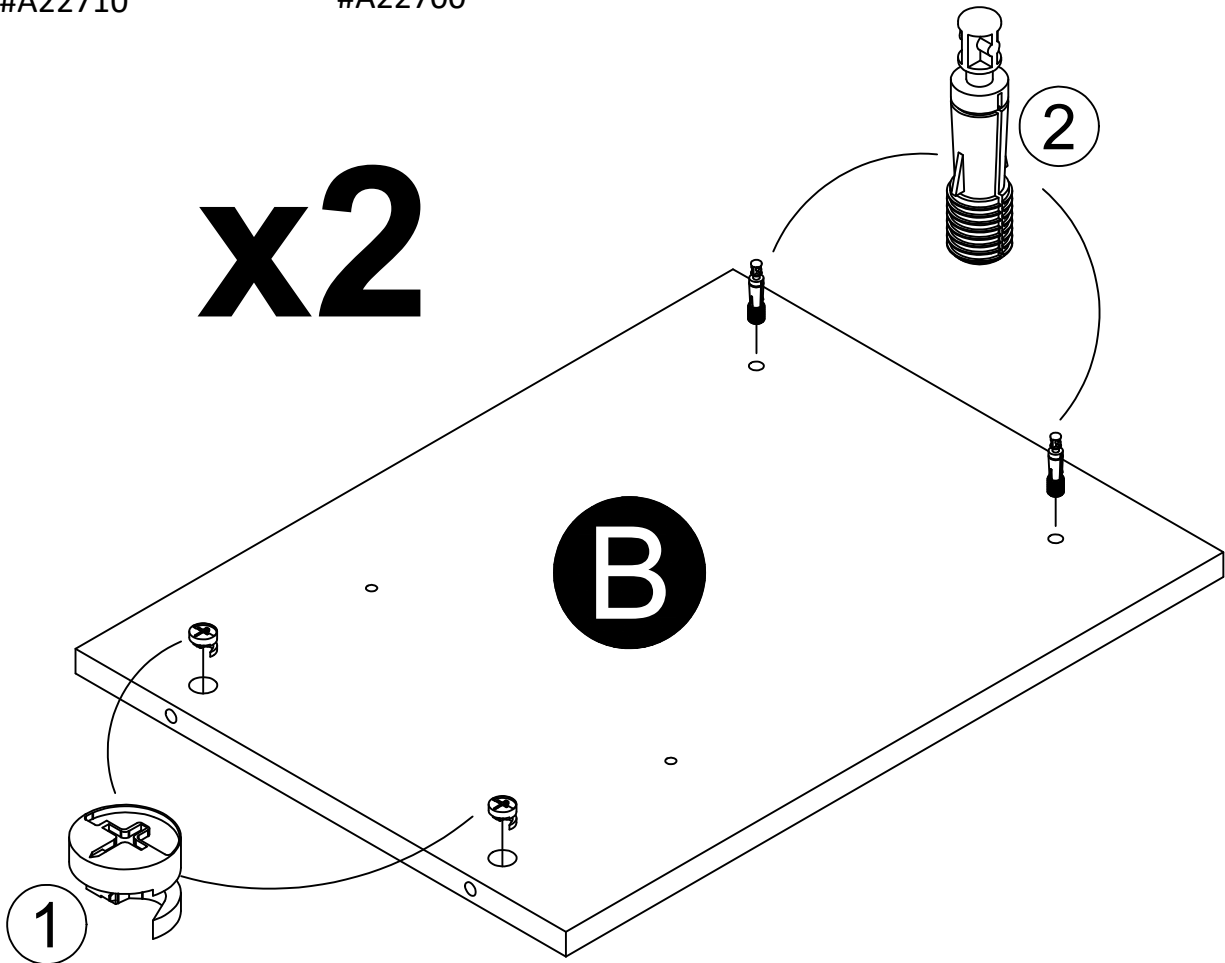

Proper orientation of CAM LOCK

## STEP 4

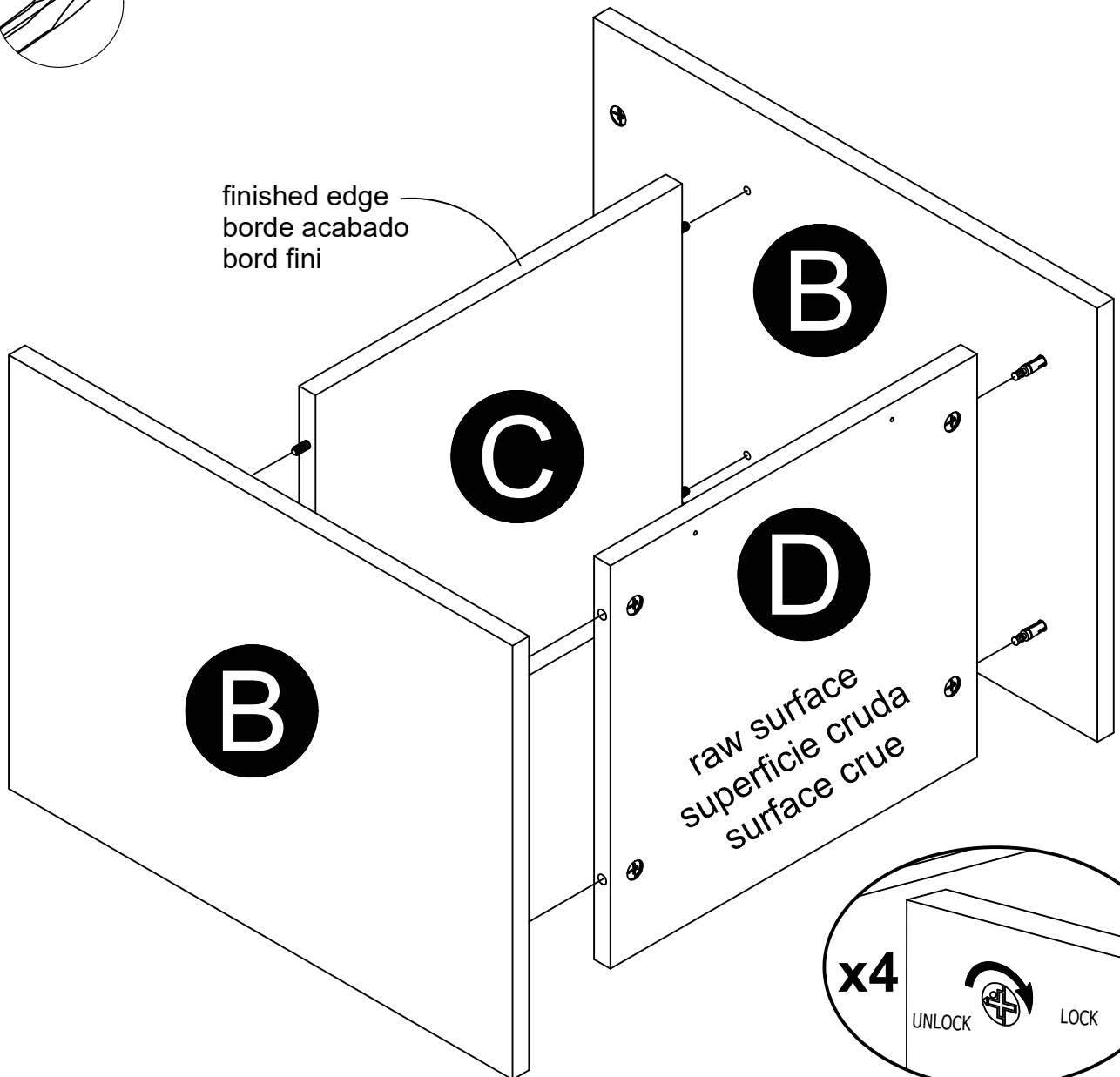
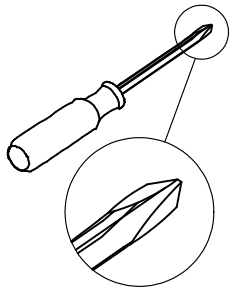

all panels need to be flush on the bottom  
todos los paneles deben estar al ras en la parte inferior  
tous les panneaux doivent être alignés sur le bas

# STEP 5

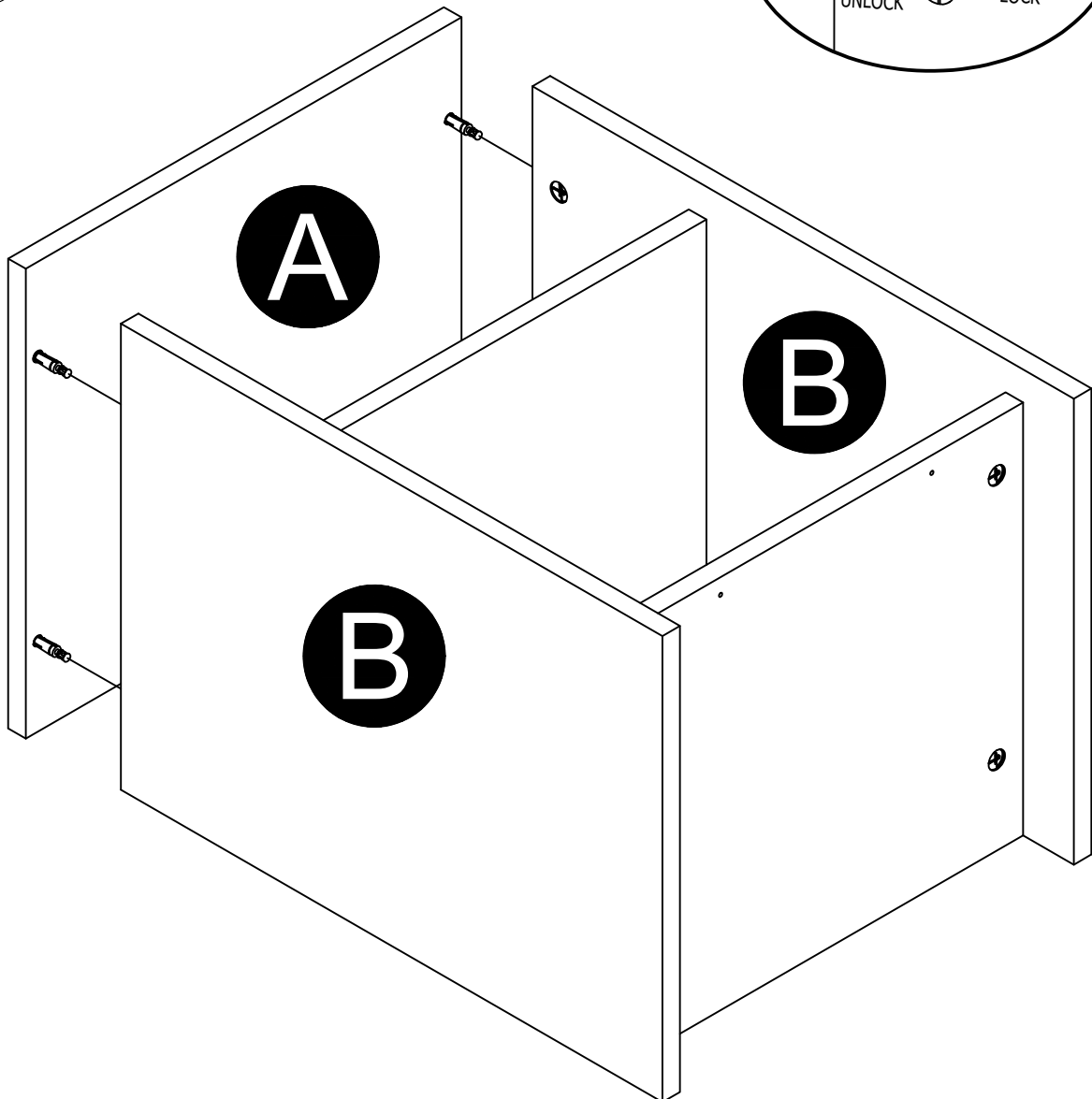
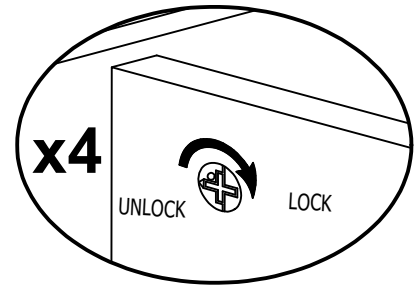
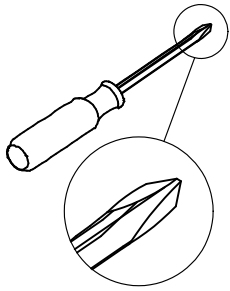

all panels need to be flush on the bottom  
todos los paneles deben estar al ras en la parte inferior  
tous les panneaux doivent être alignés sur le bas

## STEP 6

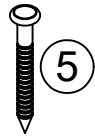

(x20)  
#A21110

**IMPORTANT!** THE BACK PANEL IS A STRUCTURAL PART OF THIS UNIT AND MUST BE INSTALLED PROPERLY.

Attach the back panel as shown nailing straight into the raw edges.  
Assure that the unit is square.  
Distance from corner to corner must be equal.

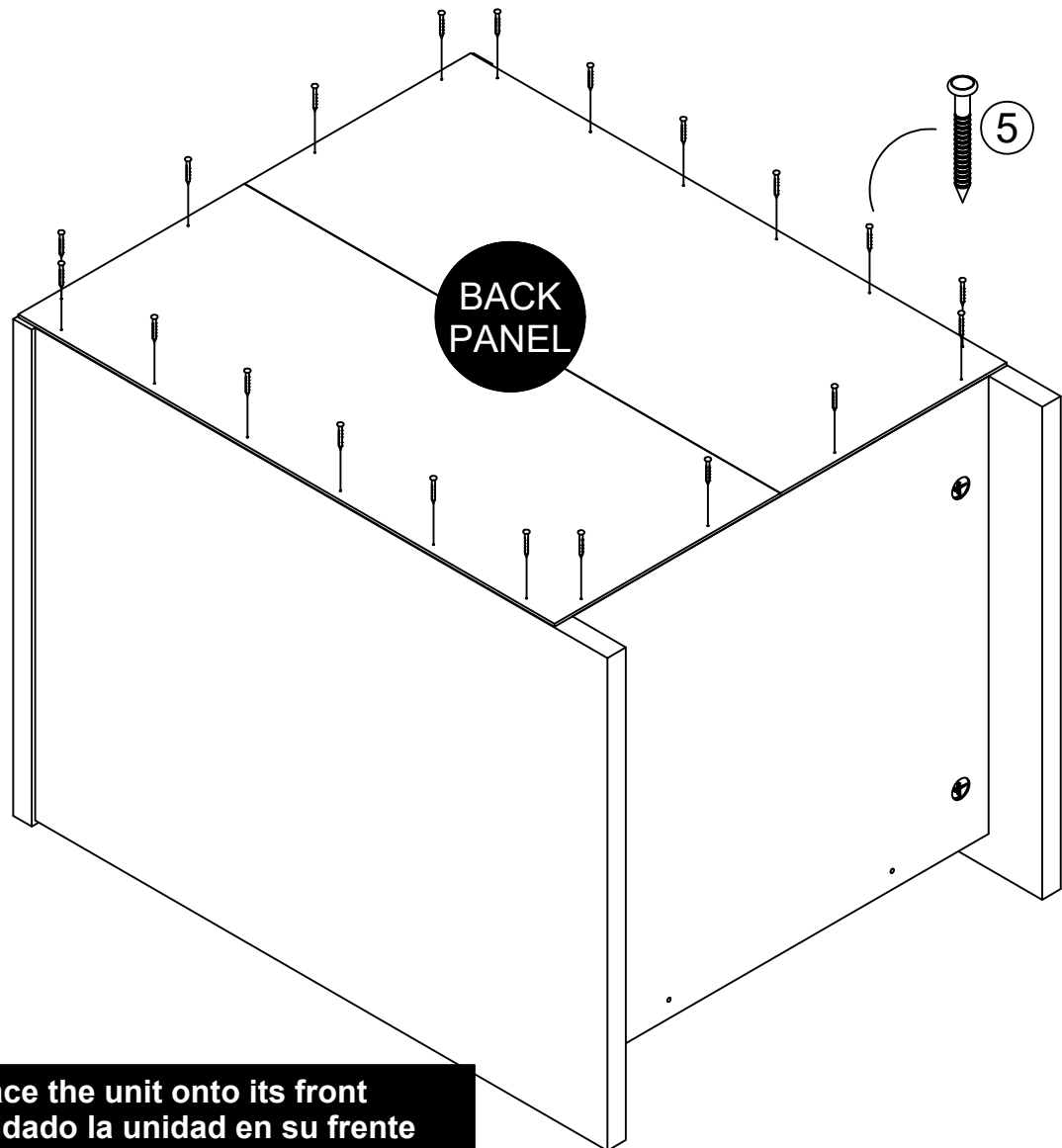

carefully place the unit onto its front  
coloque con cuidado la unidad en su frente  
placez soigneusement l'appareil sur sa face avant

## STEP 7

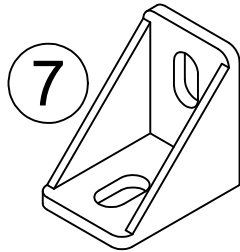
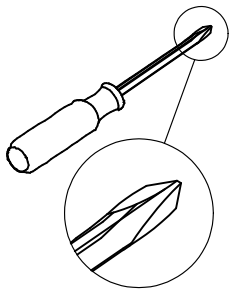

(x2)  
#A53510

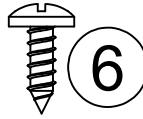

(x4)  
#A12105

raw edge  
borde crudo  
bord cru

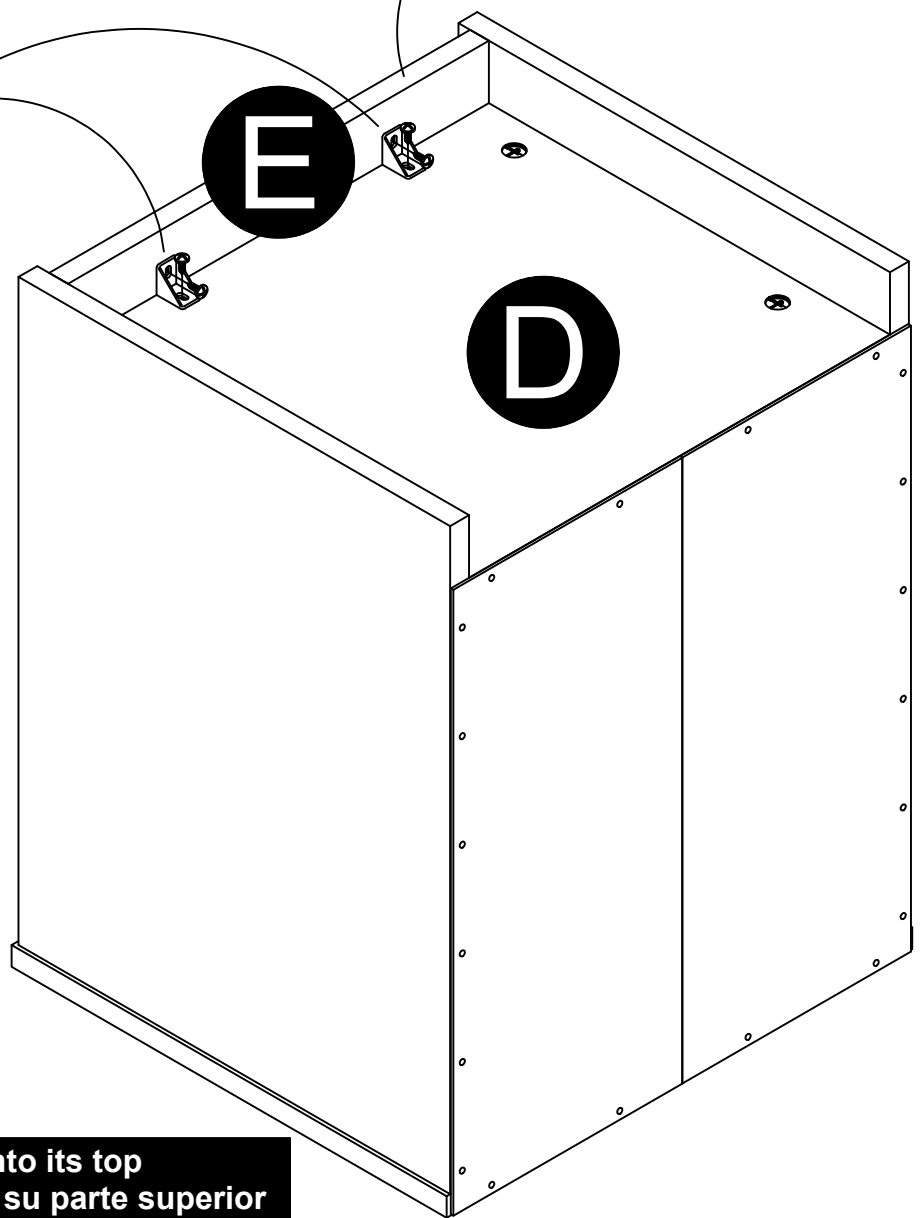
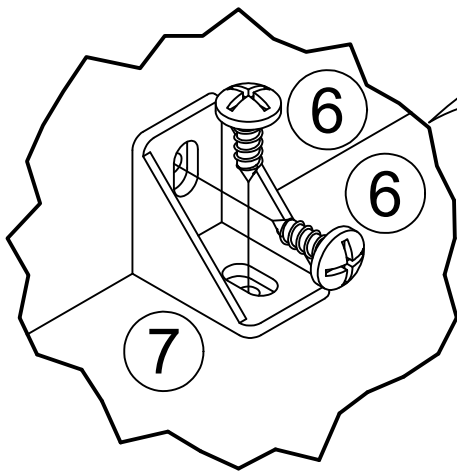

carefully place the unit onto its top  
coloque con cuidado la unidad en su parte superior  
placez soigneusement l'appareil sur son dessus

## STEP 8

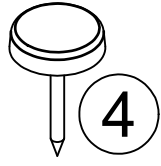
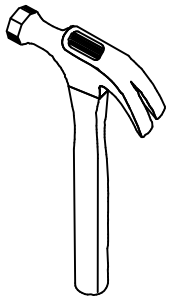

(x4)  
#A43200

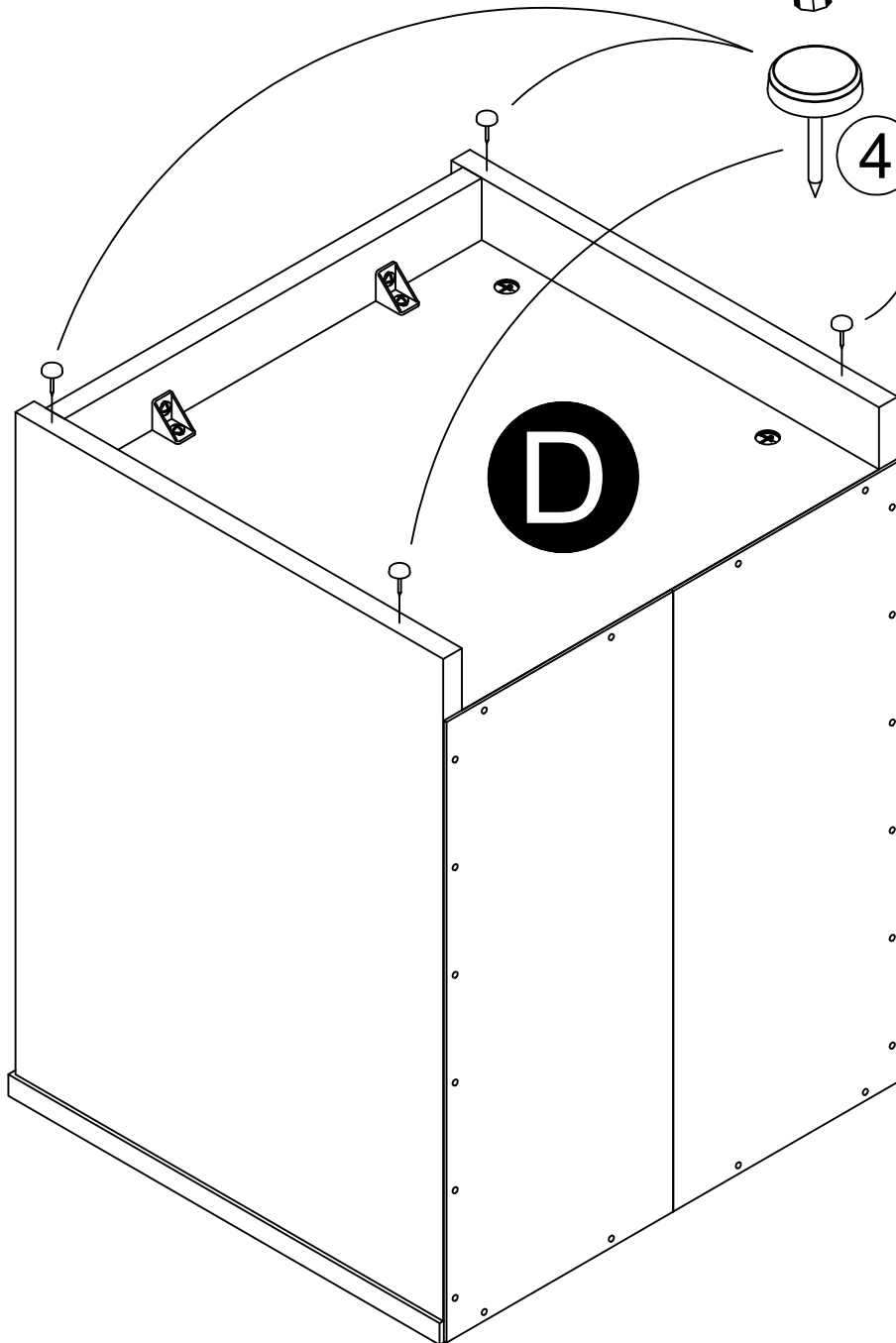
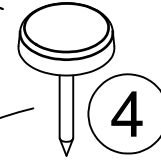
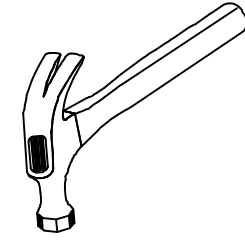

## Maximum Loads

This unit has been designed to support the maximum loads shown. Exceeding these load limits could cause sagging, instability, product collapse, and/or serious injury.

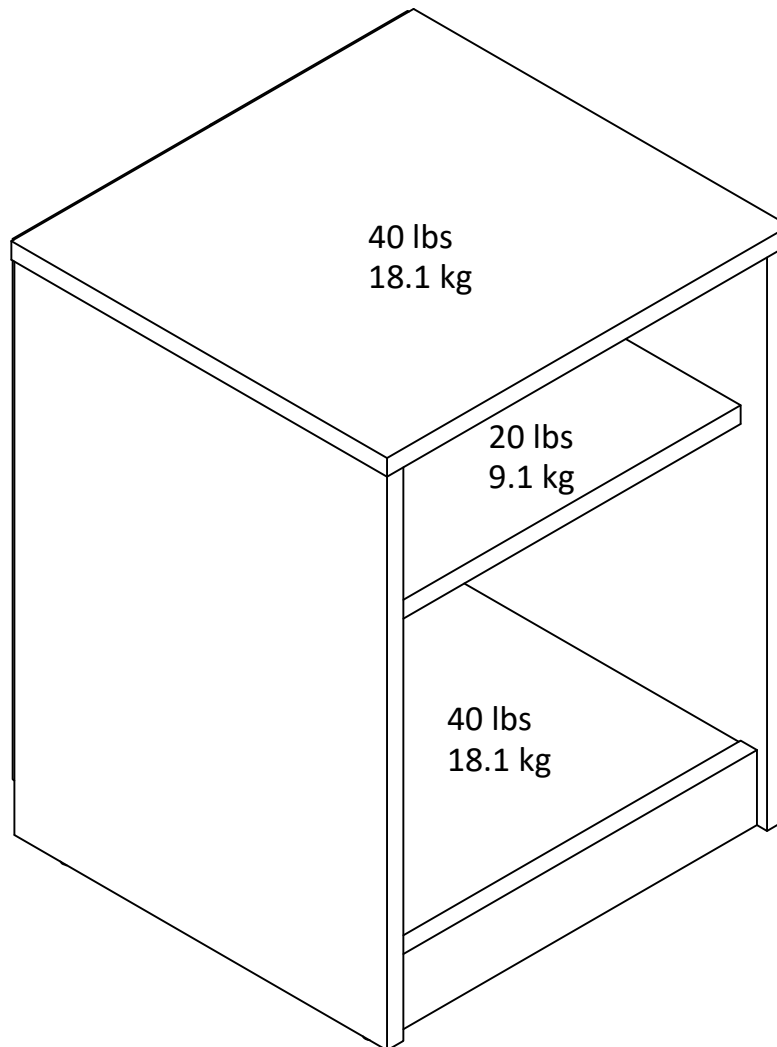

**Warning: Risk of injury to persons - do not place a television on this furniture. This furniture is not approved for use with a television.**

### Certificate of Conformity

1. This certificate applies to the Dorel Home Furnishings, Inc. product identified by this instruction manual.
2. This certificate applies to compliance of this product with the CPSC Ban on Lead-Containing Paint (16 CFR 1303).
3. This product is distributed by: Dorel Home Furnishings, Inc.  
410 East First Street South  
Wright City, MO 63390  
636-745-3351
4. Site of Manufacture: Cornwall ON
5. See front page of instruction manual for date of manufacture.

---

## Register your product to receive the following:



- \* New trend details - sneak peek on what's new
- \* Surveys - have a voice within our community
- \* Exclusive deals and discount codes
- \* Quick and easy replacement part service

To register your product, visit [ameriwoodhome.com](http://ameriwoodhome.com)

## *5 Star Rating*



Visit your local retailer's website, rate your purchased product and leave us some feedback!

We would like to extend a big "Thank You" to all of our customers for taking the time to assemble this Ameriwood Home product, and to give us your valuable feedback.

*Thank  
You!*

## Cubierta Delantera

Este libro de instrucciones contiene información **IMPORTANTE** de seguridad. Por favor lea y manténgalo para referencia en el futuro.

**No Regrese este producto!** Comuníquese con nuestro amigoso equipo de servicio al cliente para obtener ayuda.

Llámenos al: 1-800-489-3351 (Gratis) Lunes - Viernes 9am - 5pm CST

Visitar: [www.ameriwoodhome.com](http://www.ameriwoodhome.com)

## PRECAUCION

Este mueble puede volcarse y causar graves heridas y/o muerte.

Anclar el mueble a un poste de madera en la pared (si esto se requiere).

No Permita que los niños monten el mueble.

Mantenga los artículos más pesados en los cajones de abajo.

## Consejos Útiles (página 2)

- Abra su artículo en el área donde usted planea utilizarlo para evitar levantar y moverlo menos
- Identificar, ordenar y contar las piezas antes de intentar ensamblar
- Las clavijas de compresión se golpean con un martillo
- Las diapositivas están marcadas con una R (derecha) y L (izquierda) para la colocación correcta
- Asegúrese de que siempre este el punto localizado en la parte superior de bloqueador de leva este volteado hacia borde exterior
- Utilizar todos los clavos para el panel de atrás y distribuirlos por igual
- El panel de atrás debe utilizarse para asegurarse de que la unidad quede fija y firme
- No use químicas fuertes ni limpiadores abrasivos en este artículo
- Nunca empuje, tire ni arrastre los muebles

## Antes de Que Empieces (página 3)

- Lea cuidadosamente cada paso y siga el orden correcto
- Separar y contar todas sus piezas y hardware
- Dése suficiente espacio para el proceso de ensamble
- Tenga las siguientes herramientas: destornillador de cabeza plana, #2 cabeza Phillips  
Destornillador y martillo
- Precaución: Si usa un taladro electrónico o un destornillador eléctrico para atornillar, por favor asegúrese que deje de atornillar cuando el tornillo este apretado. Fallar hacer esto puede causar barrer el tornillo.

## Sistema de fijar el bloqueo de leva (página 3)

Esta sistema de fijar el bloqueo de leva sera usado en todo el proceso ensamble.

## Página 12

**¡IMPORTANTE! EL PANEL TRASERO ES UNA PARTE ESTRUCTURAL DE ESTA UNIDAD Y SE DEBE INSTALAR CORRECTAMENTE.**

Coloque el panel posterior como se muestra clavando directamente en los bordes sin rematar.

Asegúrese de que la unidad esté en escuadra.

La distancia de esquina a esquina debe ser igual.

## Página 15

### CARGA MAXIMA

Esta unidad ha sido diseñada para soportar la carga máxima anotada. El exceder estos límites puede causar inestabilidad, colapsarse y/o causar serias lesiones.

**ADVERTENCIA:** Riesgo de lesiones a las personas - no coloque un televisor sobre muebles. Este mueble no está aprobado para su uso con un televisor.

## Página 16

Registre su producto para recibir lo siguiente:

- \* Detalles de nuevas tendencias - Vistazo a lo nuevo
- \* Encuestas - alec su voz entre su comunidad
- \* Códigos de ofertas y descuentos exclusivos
- \* Fácil y rápido servicio de partes de remplace

Para registrar su producto, visite [ameriwoodhome.com](http://ameriwoodhome.com)

Clasificación de 5 estrellas

Visite el sitio web de su tienda local, califique su comprado y denos sus comentarios!

Nos gustaría enviar un gran "Agradecimiento" a todos nuestros clientes por tomarse el tiempo de ensamblar este producto de Ameriwood Home, y por darnos sus valiosos comentarios.

Gracias

## Couverture Avant

CE LIVRET D'INSTRUCTION CONTIENT DES INFORMATIONS **IMPORTANTES** SUR LA SÉCURITÉ. VEUILLEZ LIRE ET GARDER POUR UNE RÉFÉRENCE FUTURE

**Ne retournez pas ce produit!** Contactez notre équipe de service à la clientèle amicale d'abord pour obtenir de l'aide.

**Appelez-nous:** 1-800-489-3351 (sans frais) du Lundi au Vendredi de 9h à 17h Heure Centrale

**Visitez:** [www.ameriwoodhome.com](http://www.ameriwoodhome.com)

## ATTENTION

Le meuble peut basculer et causer des blessures graves ou la mort.

Ancrer le meuble à une planche murale dans le mur (si indiqué).

Ne laissez pas les enfants grimper sur le meuble.

Placez les articles lourds sur les étagères ou dans les tiroirs inférieurs.

## Astuces Utiles (page 2)

-Ouvrez votre article dans la zone que vous prévoyez de le garder pour moins de levage lourd

-Identifier, trier et compter les pièces avant d'essayer d'assembler

-Les goujons de compression sont taraudés avec un Marteau

-Les glissières sont marquées d'un R (droit) et d'un L (gauche) pour un bon placement

-Assurez-vous toujours de faire face la pointe situé sur le haut de la Serrure de Came vers le bord extérieur

-Utiliser tous les clous fournis pour le panneau arrière et les répartir également

-Le panneau arrière doit être utilisé pour vous assurer que votre appareil est robuste

-N'utilisez pas de produits chimiques agressifs ou de nettoyeurs abrasifs sur cet appareil

-Ne jamais pousser, tirer, ou faire glisser votre meuble

## Avant de Commencer (page 3)

-Lisez attentivement chaque étape et suivez le bon ordre

-Séparez et comptez toutes vos pièces et matériaux

-Donnez-vous suffisamment de place pour l'assemblage

-Avoir les outils suivants: tournevis à tête plate, #2 tournevis Phillips, et Marteau

-Attention: Si vous utilisez une perceuse électrique ou un tournevis électrique pour visser, veillez à ralentir et arrêter lorsque la vis est bien serrée. Le non-respect de cette consigne peut endommager la vis.

## Système de Fixation de Came (page 3)

Ce Système de Fixation de Came sera utilisé tout au long de l'assemblage

## Page 12

**IMPORTANT! LE PANNEAU ARRIÈRE EST UNE PARTIE STRUCTURELLE DE CET APPAREIL ET DOIT ÊTRE INSTALLÉ CORRECTEMENT.**

Fixez le panneau arrière comme indiqué en clouant directement dans les bords bruts.

Assurez-vous que l'unité est carrée.

La distance d'un coin à l'autre doit être égale.

## Page 15

### CHARGES MAXIMALES

Ce meuble a été conçu pour supporter les charges maximales indiquées. En excédant ces limites de charge, le meuble pourrait devenir instable, s'effondrer, et/ou causer des blessures graves.

**AVERTISSEMENT :** Risque de blessure corporelle - ne pas placer une télévision sur ce meuble. Ce meuble n'est pas approuvé pour une utilisation avec une télévision.

## Page 16

Enregistrez votre produit pour recevoir les éléments suivantes:

- \* Détails sur les nouvelles tendances - un aperçu sur les nouveautés
- \* Sondages - avoir une voix au sein de notre communauté
- \* Offres exclusives et codes promo
- \* Service de pièces de rechange rapide et facile

Pour enregistrer votre produit, visitez [ameriwoodhome.com](http://ameriwoodhome.com)

5 Étoiles

Visitez le site Web de votre détaillant local, évaluez votre produit acheté et laissez-nous quelques commentaires !

Nous tenons à offrir un grand "Merci" à tous nos clients pour avoir pris le temps d'assembler ce produit "Ameriwood Home", et de nous donner vos commentaires précieux.

Merci