

# ASSEMBLY INSTRUCTION

## INSTRUCTIONS DE MONTAGE

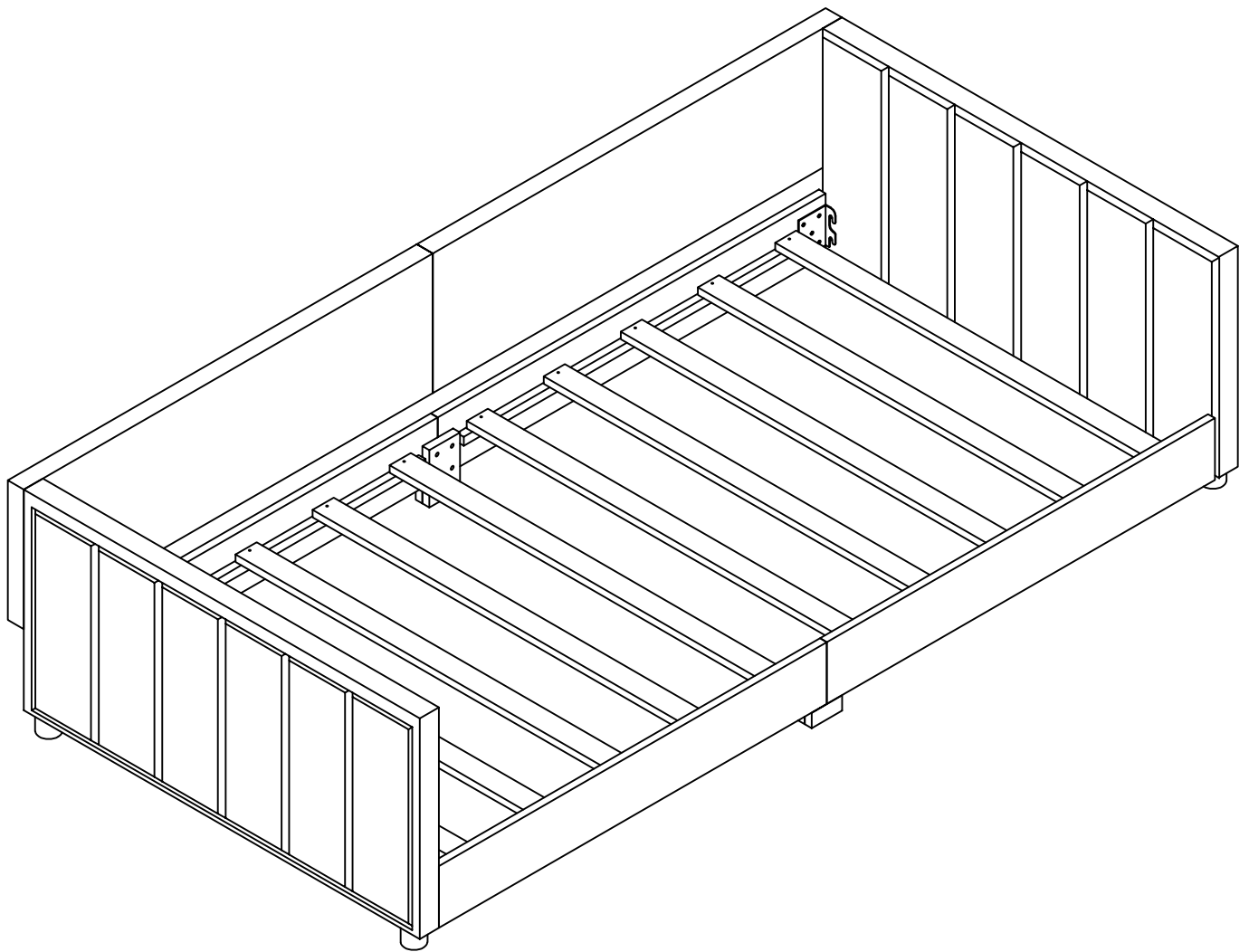

# ASSEMBLY INSTRUCTION

## INSTRUCTIONS DE MONTAGE

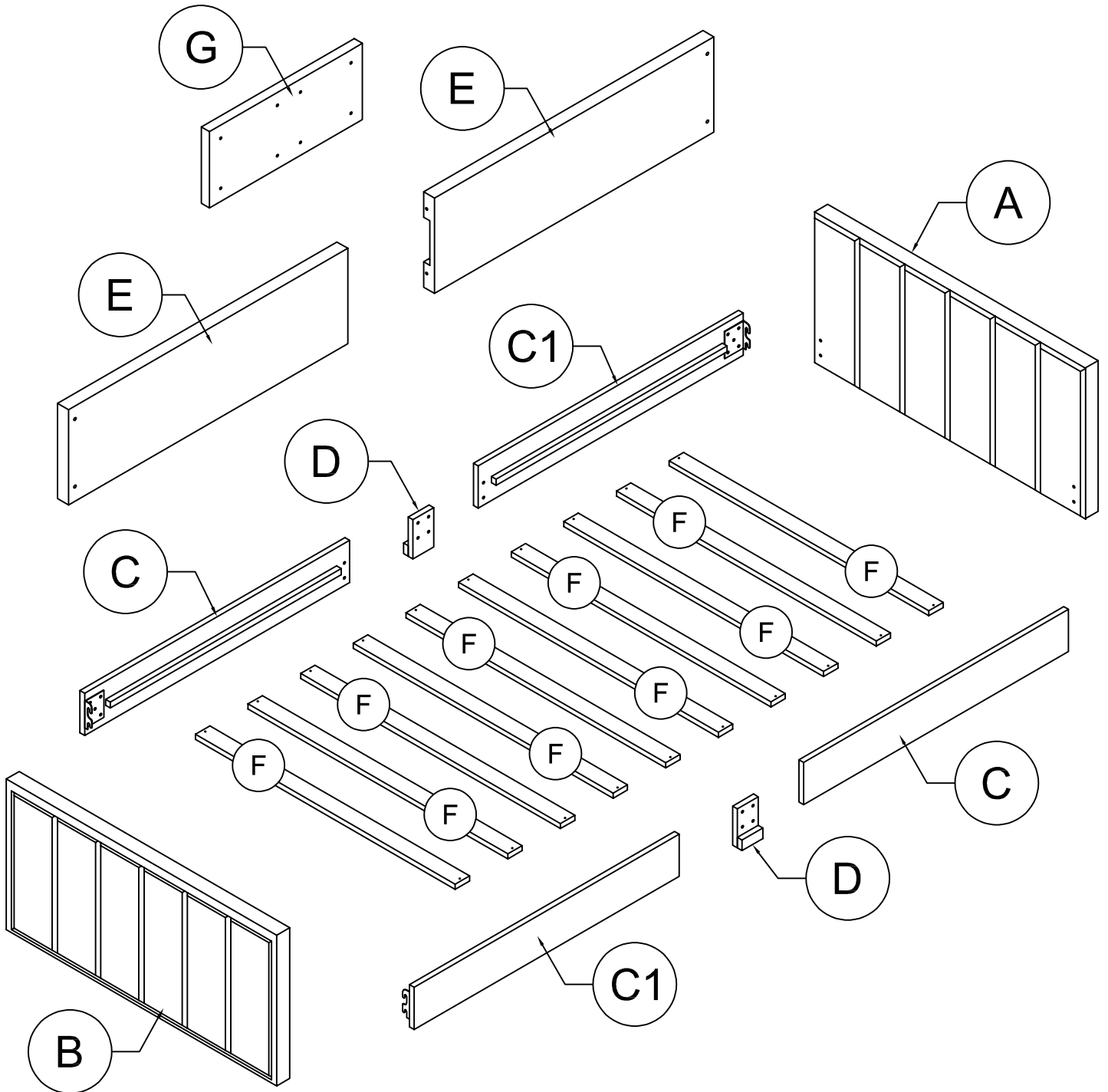

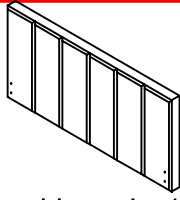
**A**

Head board - 1pcs  
Tête de lit - 1pièces

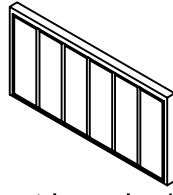
**B**

Foot board - 1pcs  
Planche à pied - 1pièces

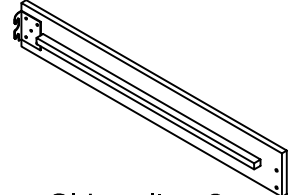
**C**

Side rails - 2pcs  
Rails latéraux - 2pièces

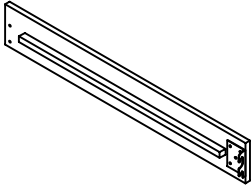
**C1**

Side rails - 2pcs  
Rails latéraux - 2pièces

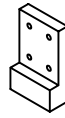
**D**

Legs support - 2pcs  
Support de jambes - 2pièces

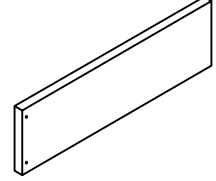
**E**



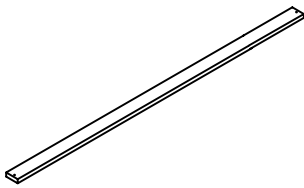

Safe hallway - 2pcs  
Couloir sécurisé - 2pièces

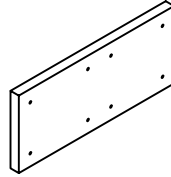
**F**

Slats - 10pcs  
Lattes - 10pièces

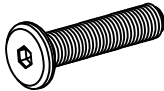
**G**

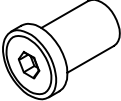
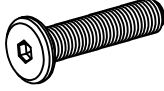
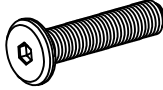
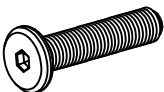
Link panel - 1pcs  
Panneau de liaison - 1pièces

<p>1</p>  <p>Plastic Feet(Ø50x40) 4pcs Pieds en plastique (Ø50x40) 4pièces</p>	<p>2</p>  <p>1/4" x 35mm Hex-Head bolts 18pcs Boulons à tête hexagonale 1/4"x35mm 18pièces</p>	<p>3</p>  <p>M4 x 30 mm Wood Screws 20pcs Vis à bois M4 x 30 mm 20pièces</p>
<p>4</p>  <p>1/4" x 25mm Sleeve Nut 4pcs Écrou à manchon 1/4" x 25mm 4pièces</p>	<p>5</p>  <p>1/4" x 60mm Hex-Head bolts 2pcs Boulons à tête hexagonale 1/4"x60mm 2pièces</p>	<p>6</p>  <p>1/4" x 30mm Hex-Head bolts 8pcs Boulons à tête hexagonale 1/4"x30mm 8pièces</p>
<p>7</p>  <p>1/4" x 50mm Hex-Head bolts 2pcs Boulons à tête hexagonale 1/4"x40mm 2pièces</p>	<p>8</p>  <p>Allen Key 2pcs Clé Allen 2pièces</p>	

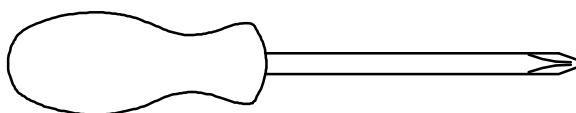

**Assembly Tools Required (Not Included)**  
**Outils d'assemblage requis (non inclus)**

**STEP 1:** Following below illustration:

**ÉTAPE 1:** Illustration ci-dessous :

1

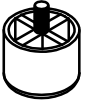

4pcs

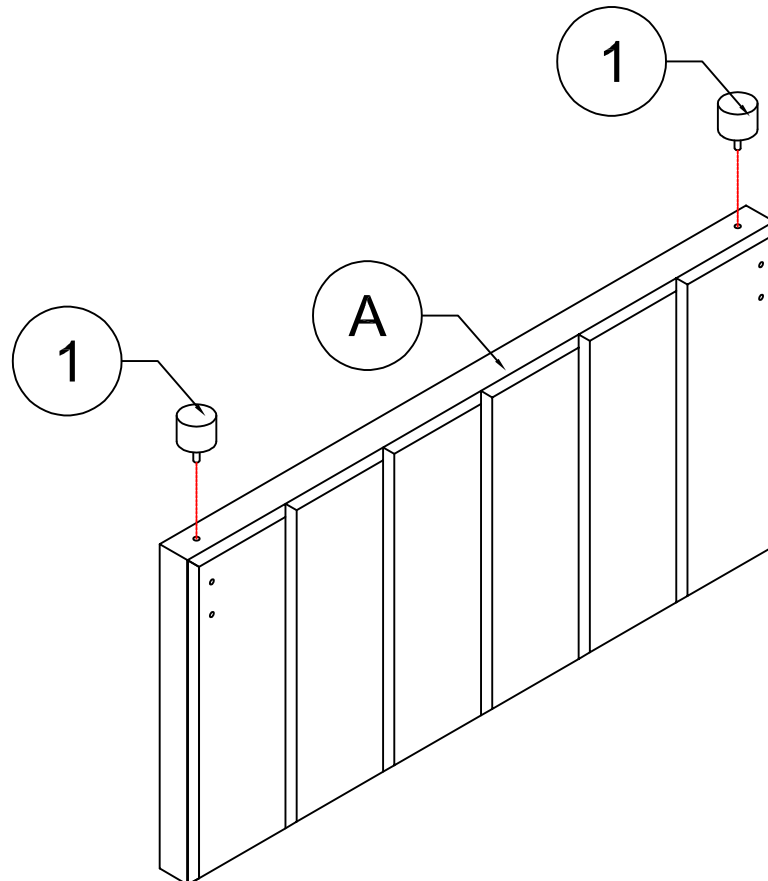
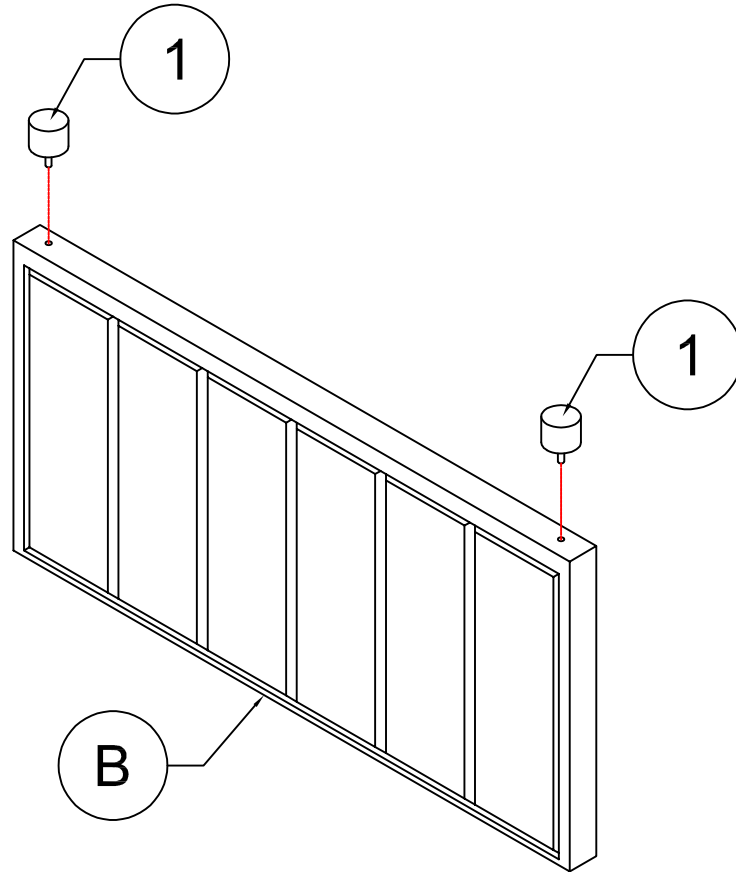

**STEP 2:** Following below illustration:

**ÉTAPE 2:** Illustration ci-dessous :

2

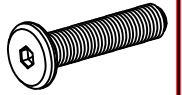

8pcs

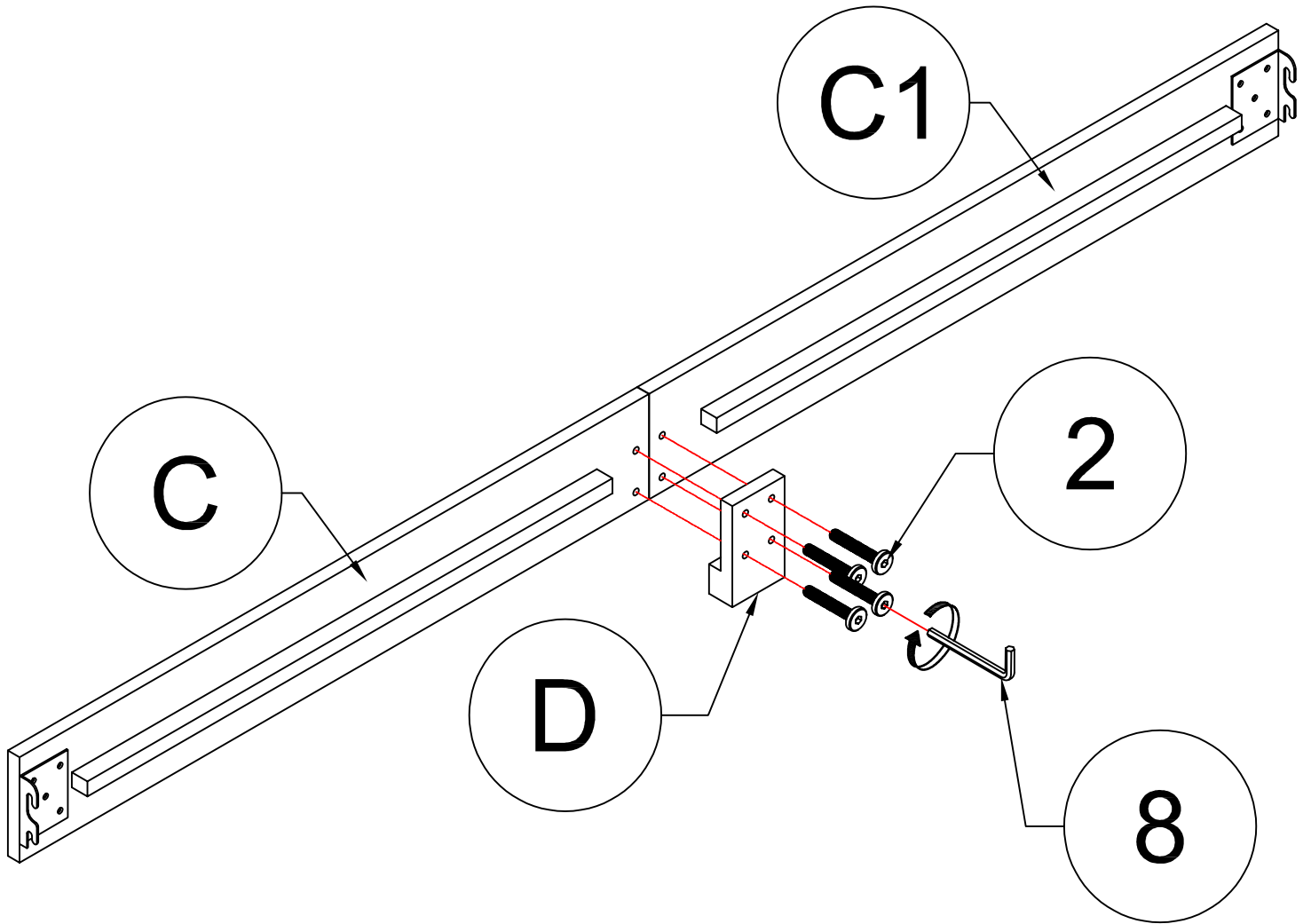

**X2**

**STEP 3:** Following below illustration:

**ÉTAPE 3:** Illustration ci-dessous :

2

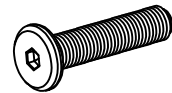

8pcs

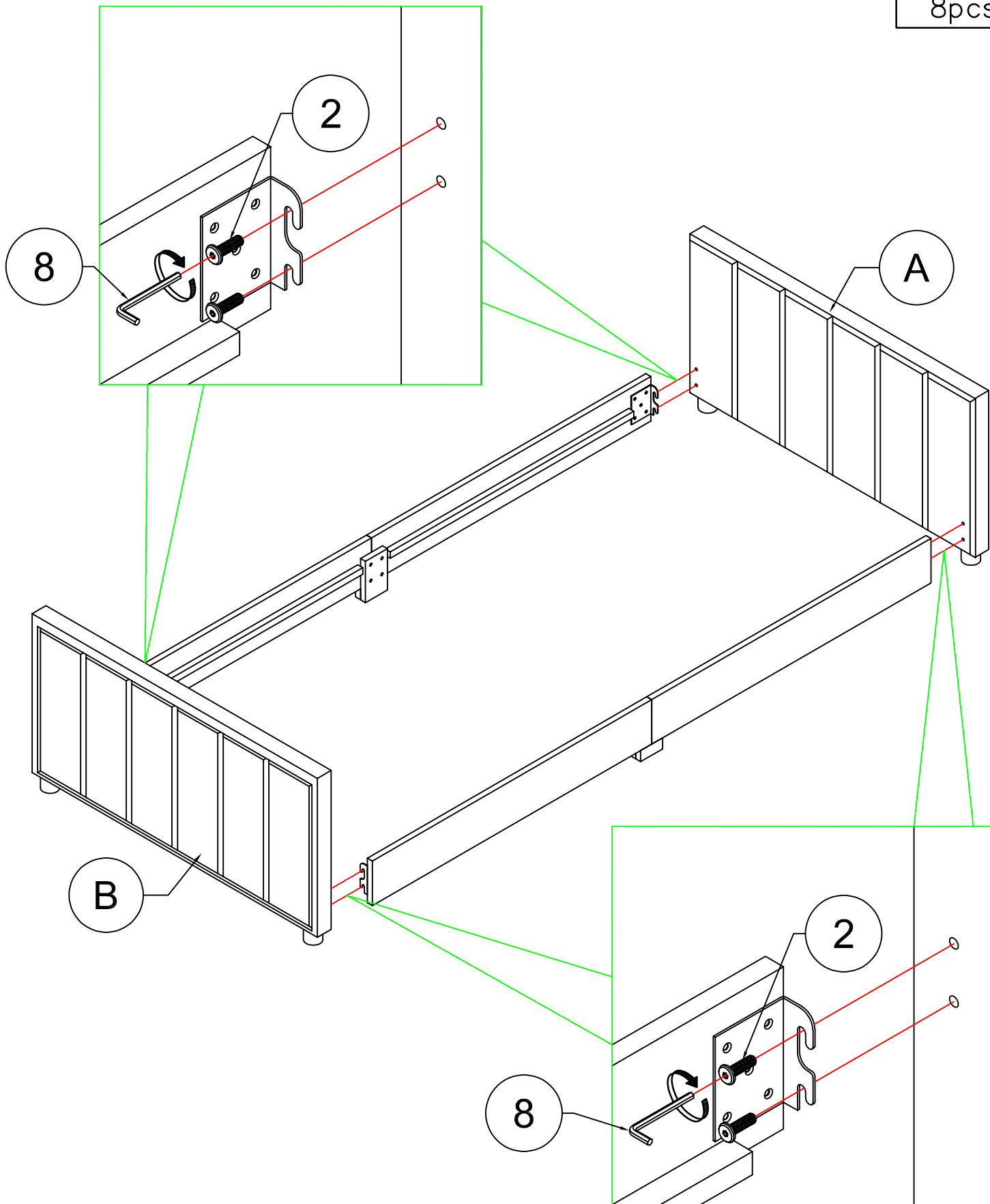

STEP 4: Following below illustration:

ÉTAPE 4: Illustration ci-dessous :

3



20pcs

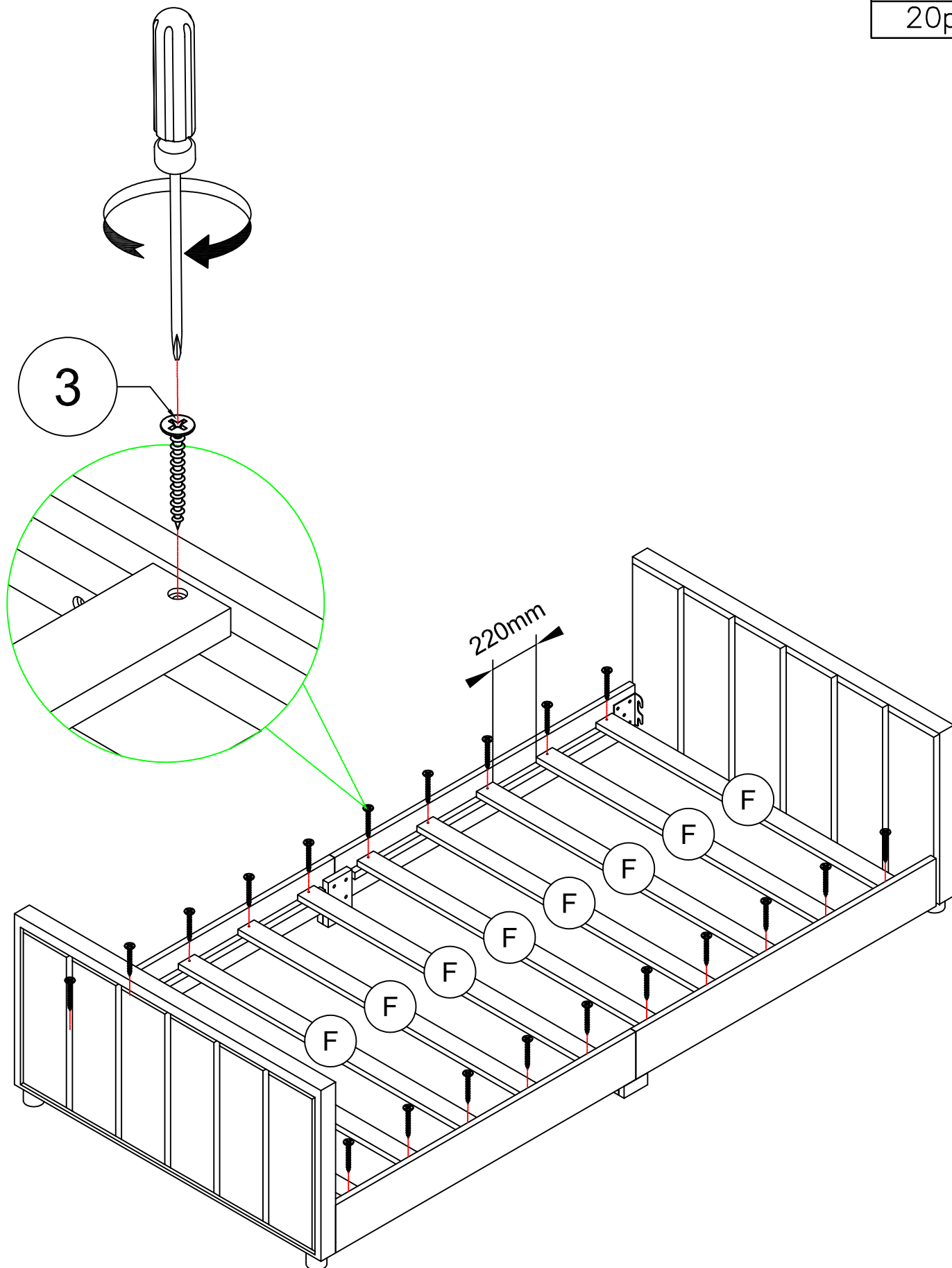

**STEP 5:** Following below illustration:

**ÉTAPE 5:** Illustration ci-dessous :

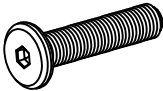
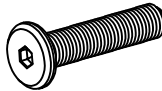
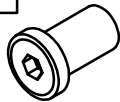
2	6	4
		
2pcs	8pcs	2pcs

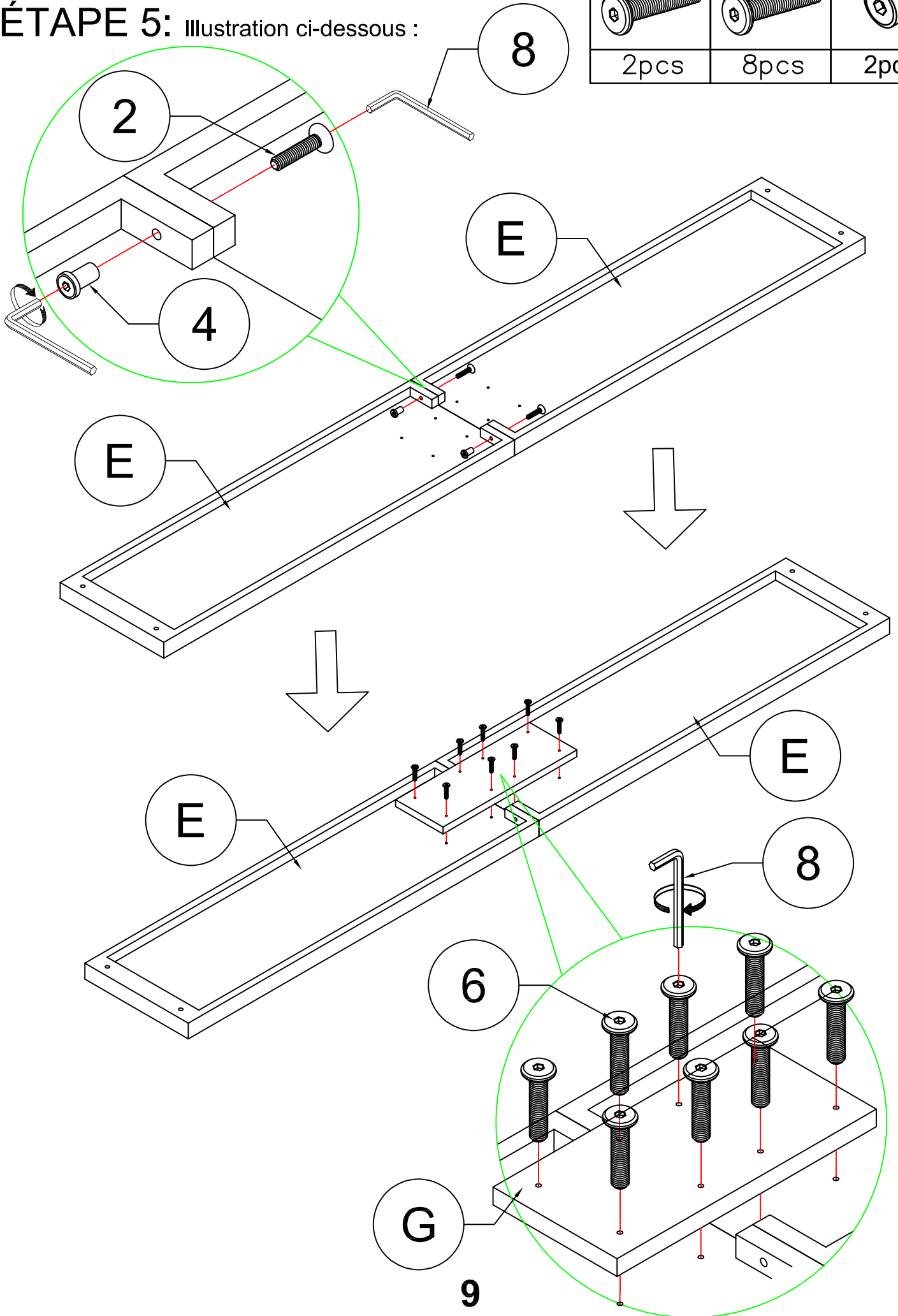

**STEP 6:** Following below illustration:

**ÉTAPE 6:** Illustration ci-dessous :

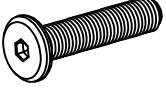
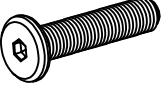
4		5		7	
	2pcs		2pcs		2pcs

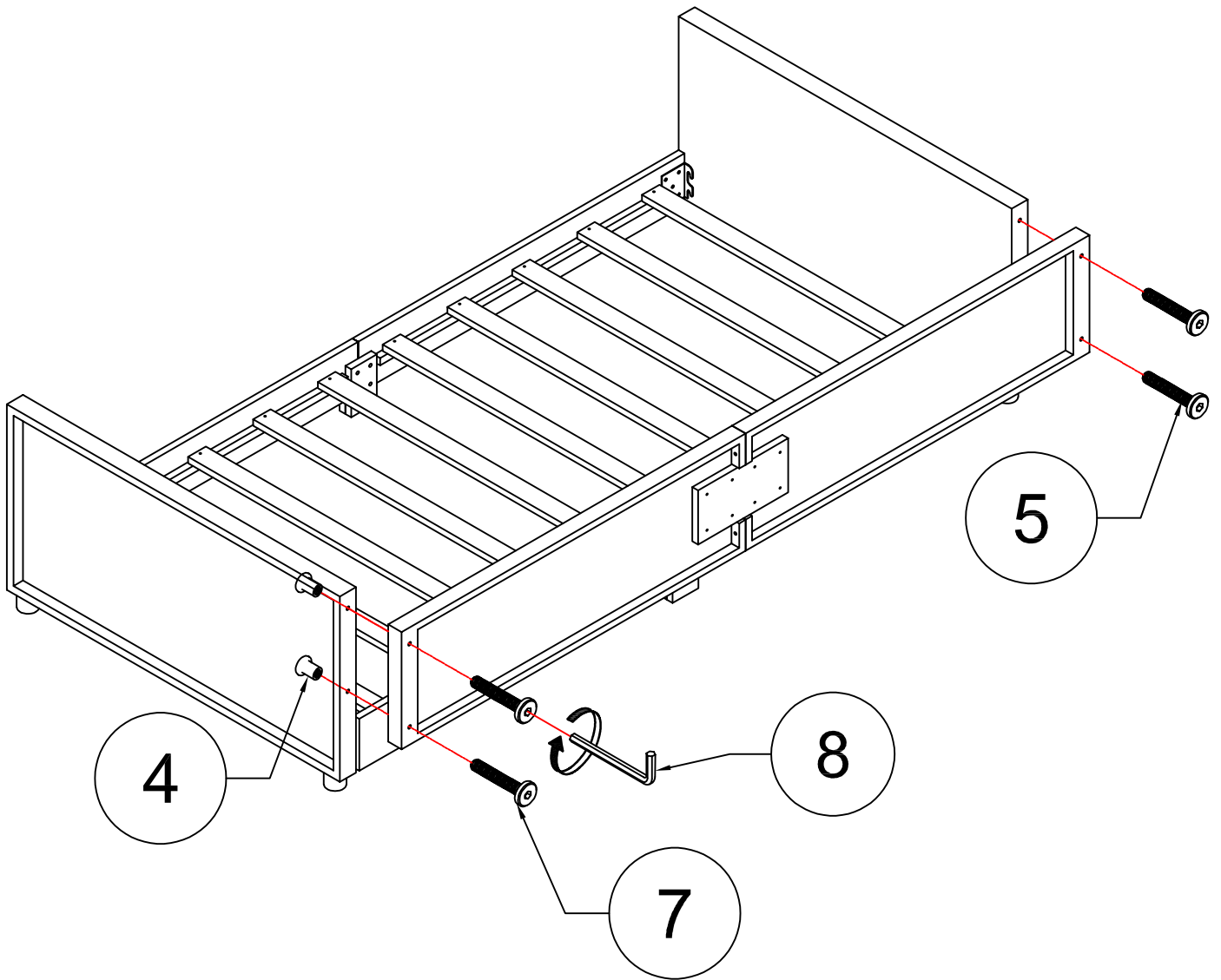

# FINISH FINITION

