

# HULALA

HOME

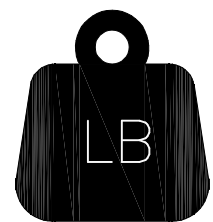
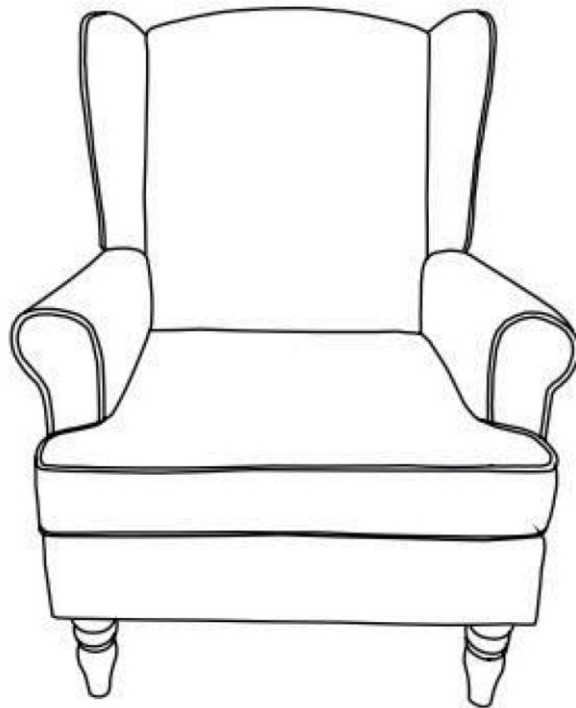

Per Seat Weight Limitation  
**300LBS**

**ITEM NO.CHHD0420**

Thank You For Choosing Our Furniture

【If you have any questions or concerns  
don't hesitate to reach out to us.】

Call us: +1(833)324-2464  
Email: [hello@hulalahome.com](mailto:hello@hulalahome.com)

**NOTE:**





This brochure contains  
**IMPORTANT** safety info.  
Please read and keep it  
for future reference.

# MAINTENANCE AND WARNINGS



## Before You Start

### ***Please follow the steps below:***



-  Check the packaging for any damage, deformation, or water stains. If there is significant damage, please contact us promptly.
-  Unpack the box and compare the contents with the parts list and hardware list to ensure all components and accessories are present and complete.
-  Please read the installation instructions carefully to understand the installation steps and precautions to ensure proper installation.
-  Clean the installation area in advance and ensure the ground is level and there is enough space to avoid damaging the furniture or making installation difficult.
-  Lay a protective mat on the ground to prevent scratching the floor during installation.

### ***After-Sales Service***

- If you encounter any issues or need technical support during use, please contact our after-sales team. We offer long-term maintenance and warranty services.





## Precautions

-  This product is for indoor use only. Do not expose it to outdoor elements or high-humidity environments.
-  Keep the product away from high heat or open flames to prevent fire hazards.
-  Do not allow children to climb on the product, as this may cause tipping and result in personal injury.



## Safety Warnings

-  If you notice any loose or damaged parts, stop using the product immediately and contact customer service.
-  Do not attempt to disassemble or replace any components yourself, as this may affect the stability and safety of the product.

### **Daily Maintenance**

- Regularly clean the surface with a soft cloth to prevent dust accumulation.
- Do not use cleaning agents containing acids, alkalis, or corrosive substances, as they may damage the surface. It is recommended to use neutral cleaning agents or specialized furniture cleaners.
- Avoid exposing furniture to humid environments for extended periods. Use a dehumidifier or desiccant during humid weather.
- Avoid direct contact of furniture with water. If water is accidentally spilled, wipe it dry immediately.
- Avoid placing excessively heavy objects on the furniture: ensure the weight is within a reasonable load-bearing range.
- Avoid using sharp or rough items on the furniture surface to prevent scratches. Handle items gently when moving them.

# Parts

## List

A

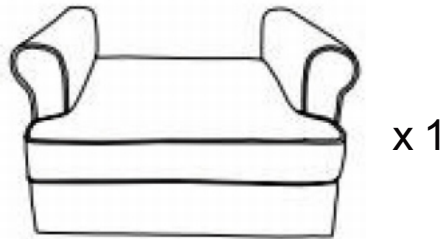

Seat

B

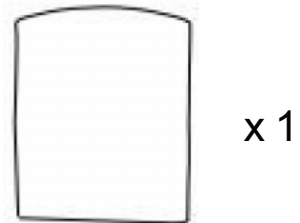

Back

C

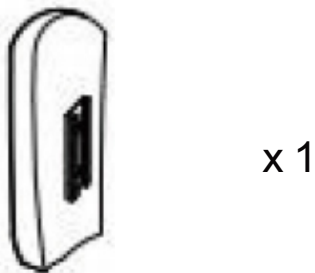

Left wing

D

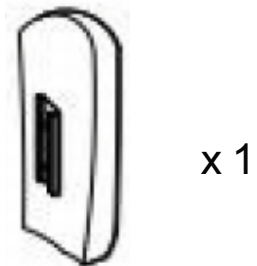

Right wing

E



(At the bottom of A)

Front leg

F



(At the bottom of A)

Back leg



Installation:  
20minutes.



One Person

# Hardware List

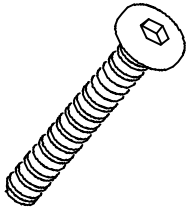
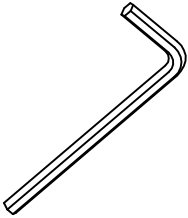
<p>①</p>  <p>x 16+1</p> <p>M6*18</p>	<p>②</p>  <p>x 1</p> <p>M6</p>	

Step 1

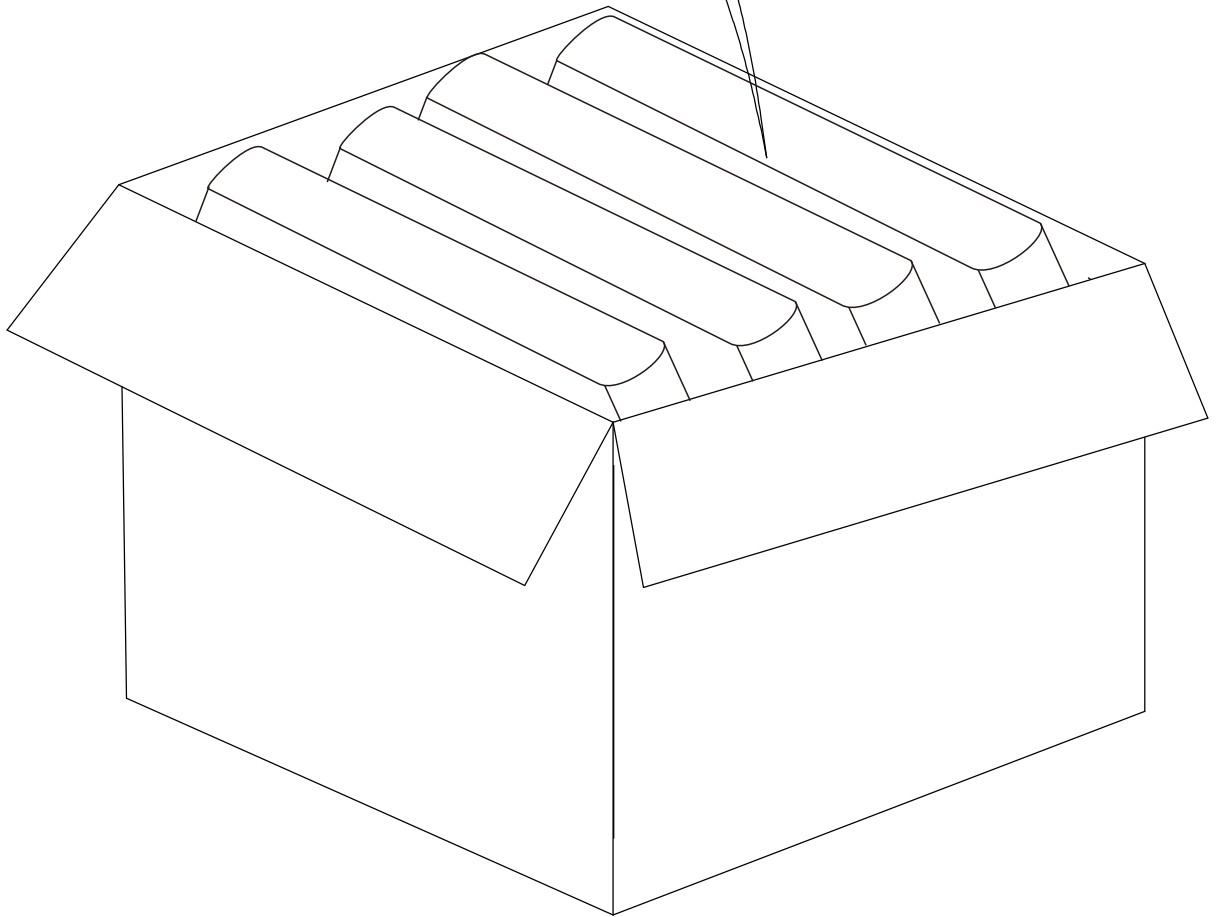
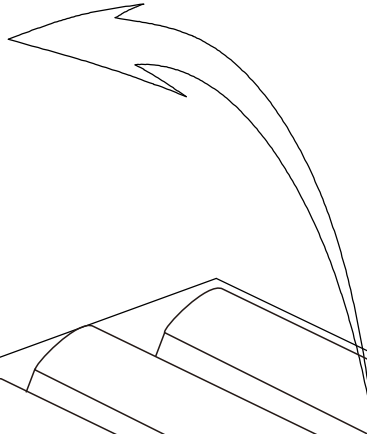
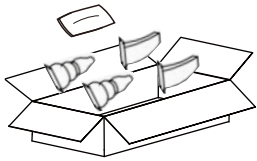
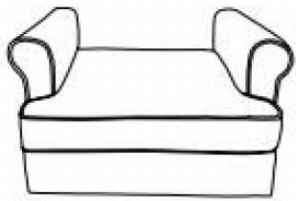

Take the parts out of the box.

## Step 2

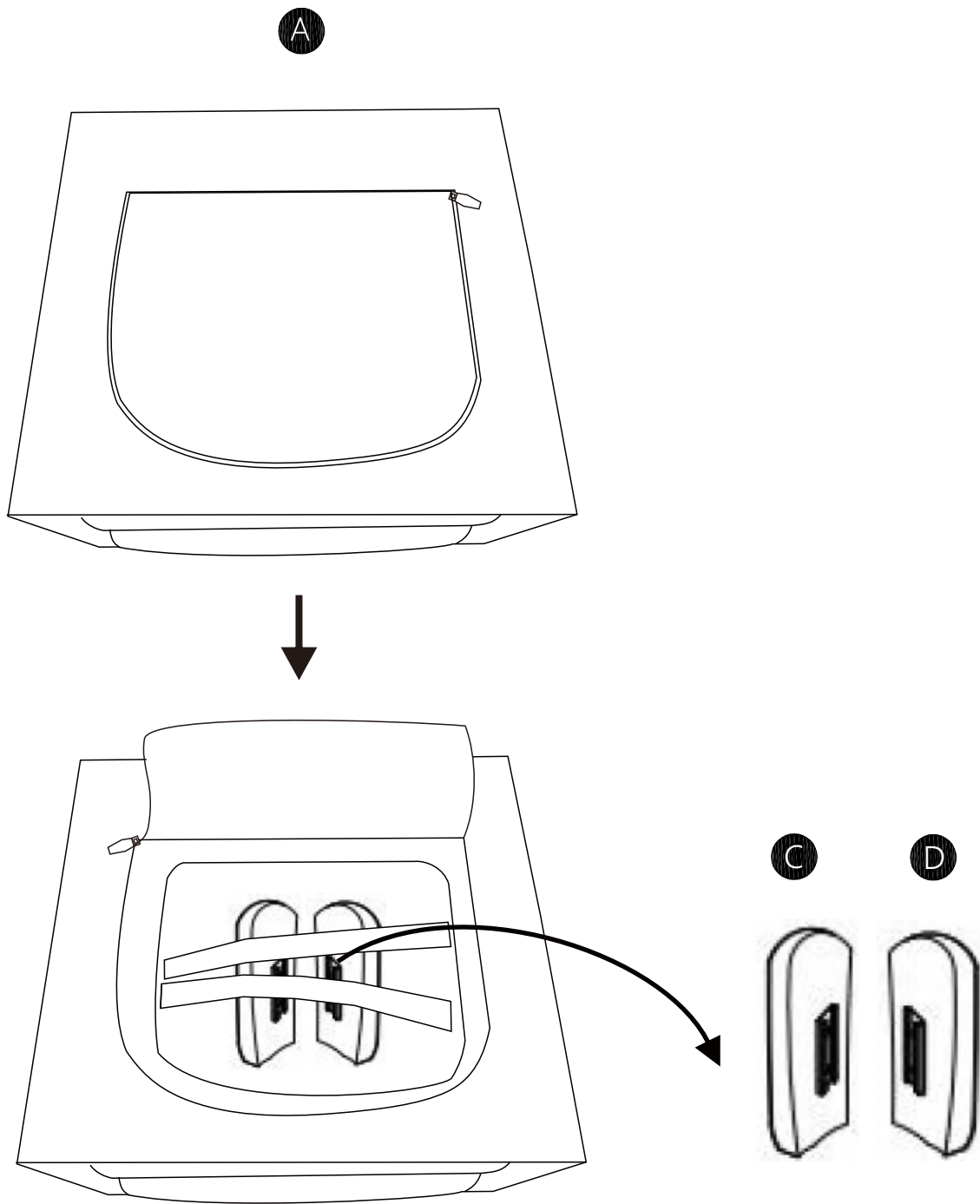



Take the handrail out from the bottom of the seat and then pull up the zipper.

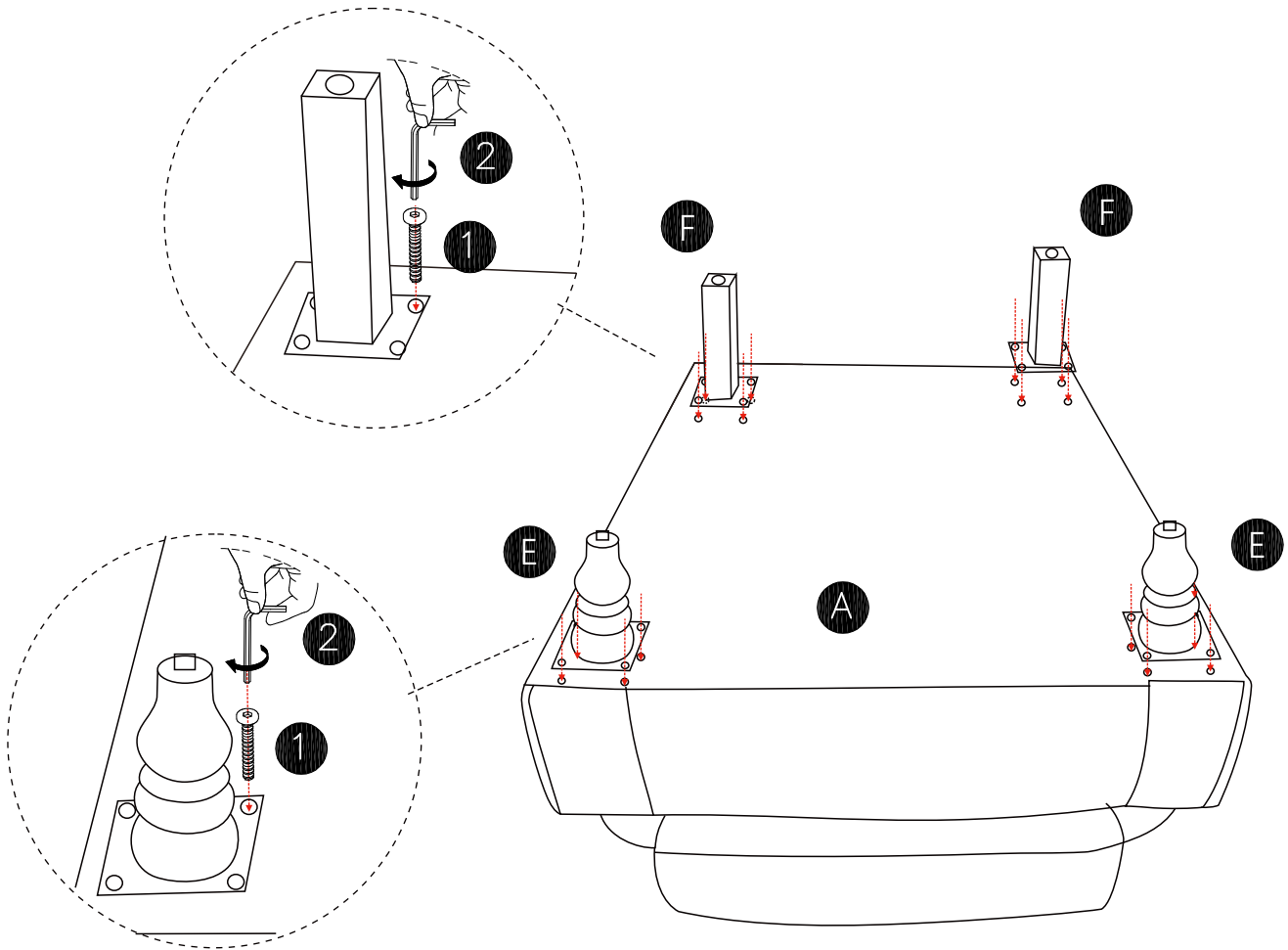

# Step 3



Install front foot E and rear foot F to the bottom of seat A.

 Please tighten the screws to 80% first, and tighten all screws 100% after all parts are assembled.

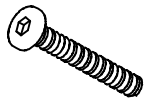
<b>1</b>	x16	<b>2</b>	x1
			
M6*18		M6	

## Step 4

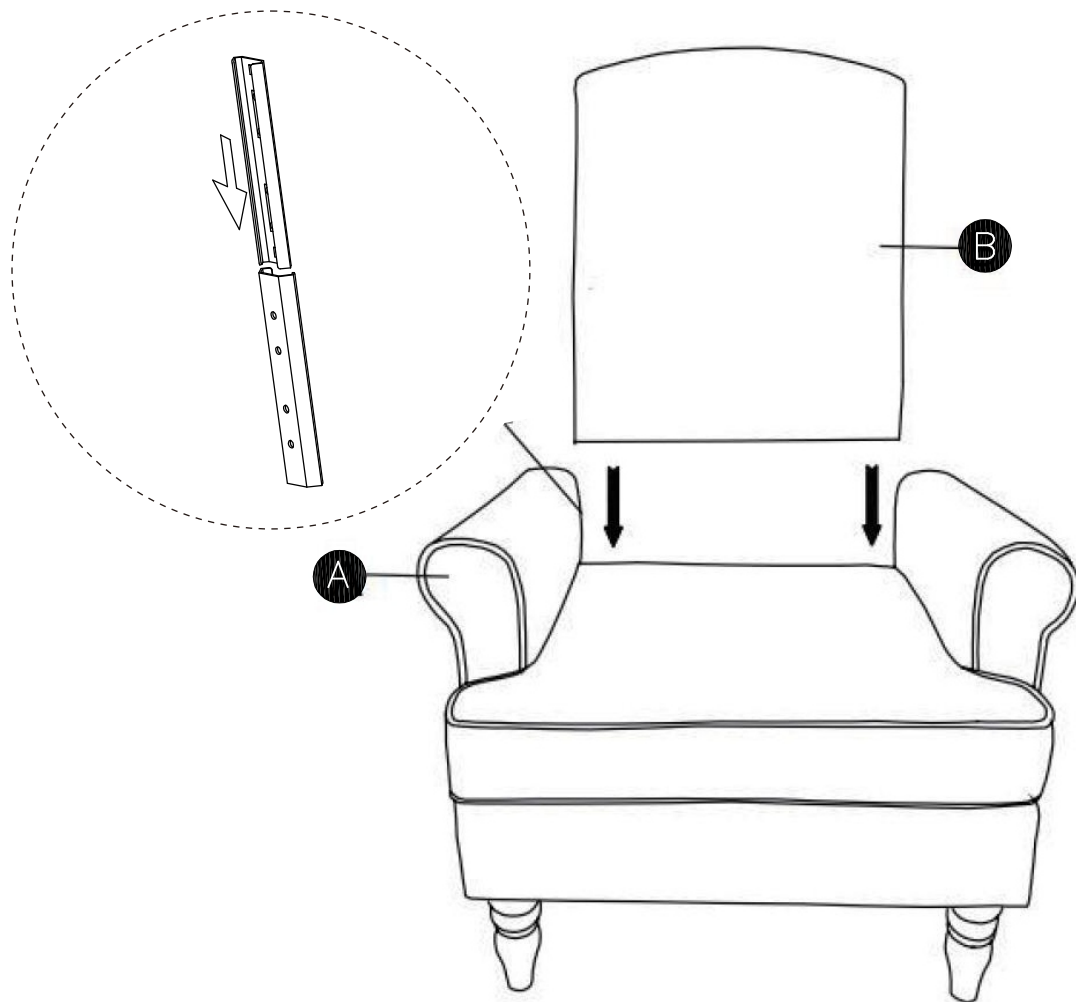

Match both bracket of backrest B to the seat A ,pushdown the backrest to assemble

## Step 5

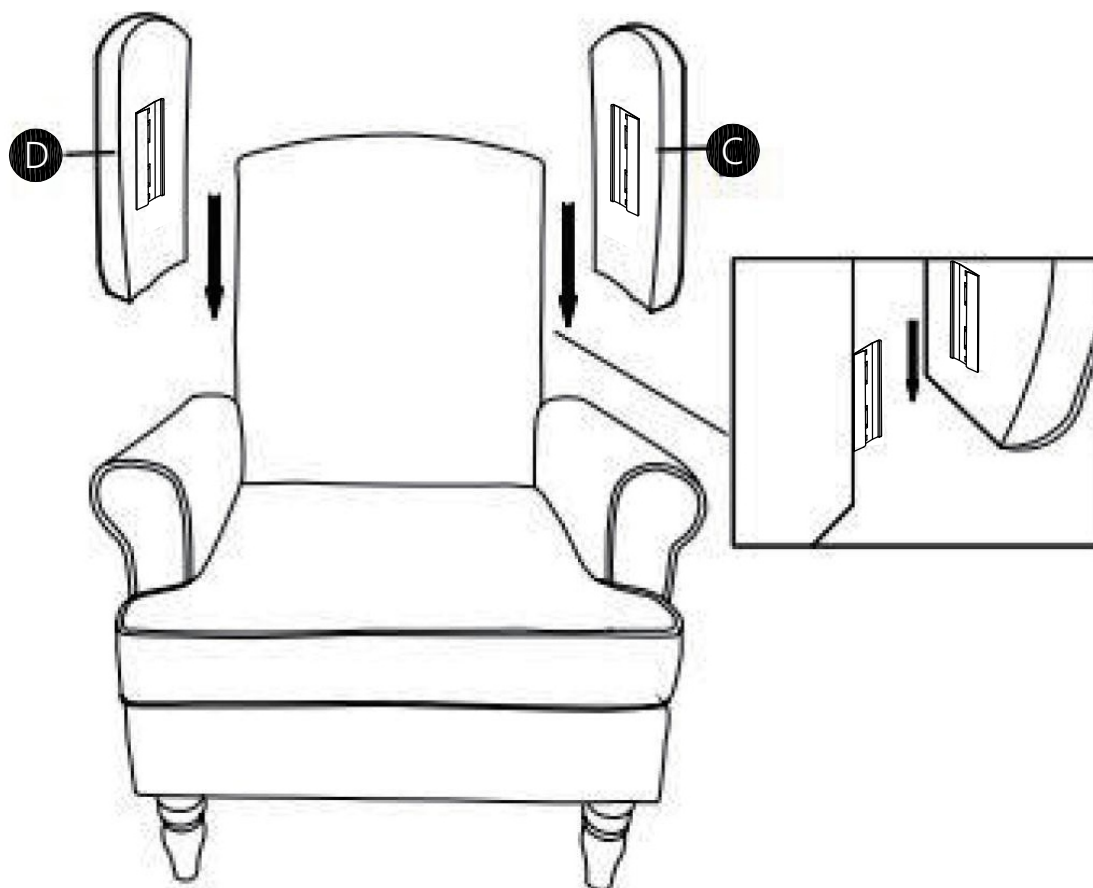

Match the left wing C and right wing D bracket to the backrest B side ,  
push down the left wing C and right wing D to assemble.

## Step 6



Attention:  
After installation, adjust the  
adjustable leveler to keep  
the chair balanced .

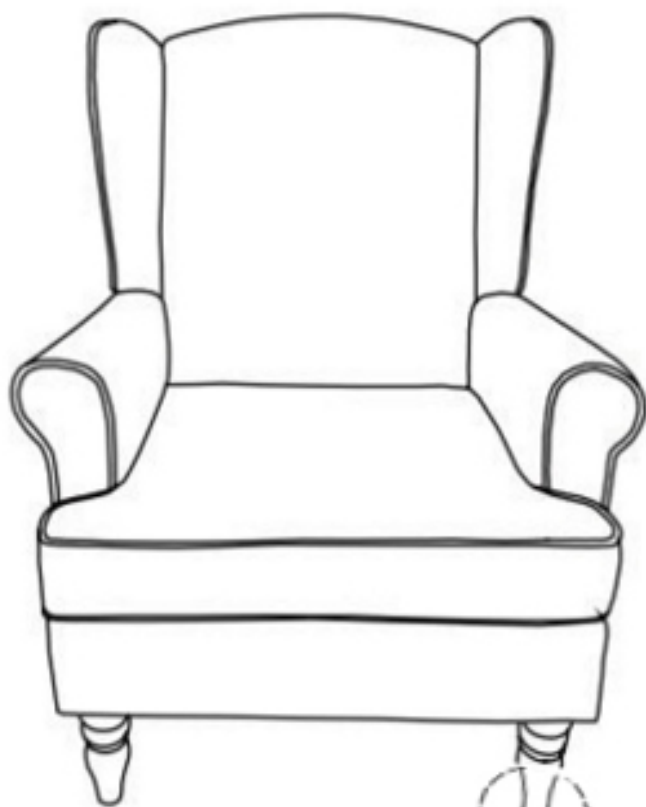

# WARRANTY

- We strive to offer quality products, and we also try our best to satisfy every customer who orders from us with products or services as needed.
- Replacement parts can be purchased from our company if available.
- For returns, please check the return policy with the retailer or marketplace where you purchased the item.

## ***Are you having difficulty***

With assembly? Missing parts?  
Please send an email with your order No. to  
[hello@hulalahome.com](mailto:hello@hulalahome.com)

We appreciate your purchase.  
Brighten your life with our furniture!