

ASSEMBLY INSTRUCTIONS

BED - TWIN

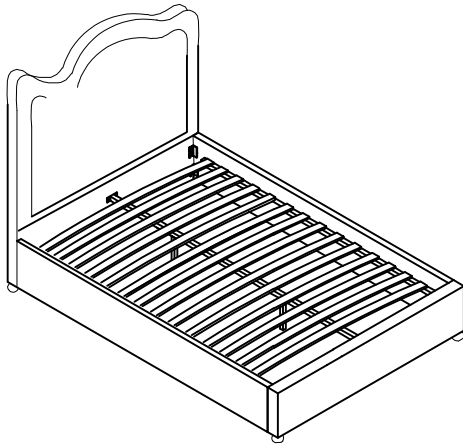

+ Parts Included

① Head Board
(1pc)

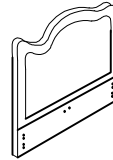

② Foot Board
(1pc)

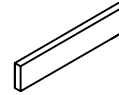

③ Side Rails
(2pcs)



④ Chrome
Legs (4pcs)



⑤ Center Support
Bar(1pc)

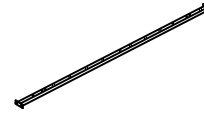

⑥ Support
Legs(2pcs)



⑦ Slats joint
(1set=12pcs)

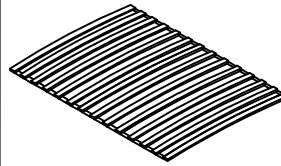

*Slats come packed
in the bottom of
headboard carton.

+ Do Not Use Power Tools

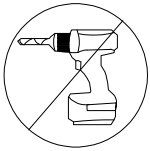

+ Suggested Adults

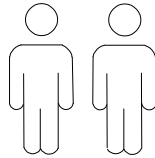

NOTE:

- 1 Read instructions cover to cover.
- 2 Save all packaging until assembly is completed.

1 IMPORTANT SAFETY INFORMATION

Do not assemble the product if any of the following parts arrived damaged:

- Part #③ -Side Rails
- Part #⑤ -Center Support Bar
- Part #⑥ -Support Legs
- Part #⑦ -Slats joint

2 IMPORTANT ASSEMBLY INFORMATION

Assembly Step ③ Ensure the side rail bracket is fully hooked onto bolt **A** loosely threaded with both washers on the **OUTSIDE** of the bracket first, then proceed to fully tightening all 4 corners.

*Slats come packed in the bottom of headboard carton.

+ Hardware Included

A Bolt M8*40mm
(24pcs)



C Spring Washer
(16pcs)



E Flat Washer
Φ20(24pcs)



F M8 Allen Key
(1pc)



I Nut M8*13mm
(4pcs)



J Spanner
(1pc)



ASSEMBLY INSTRUCTIONS

BED - TWIN

