















Assembly Instruction

UPHOLSTERED BARSTOOL

NO	Parts List		Q'TY
A		Chair Back	1 Pce
B		Seat Assembly	1 Pce
C		Left Front Leg	1 Pce
D		Right Front Leg	1 Pce
E		Left Side Stretcher	1 Pce
F		Right Side Stretcher	1 Pce
G		Front Stretcher	1 Pce

NO	Hardware List		Q'TY
1		8 x 1.1/4" Pan Head Screw	6 Pcs
2		M6x 40mm JCBC Bolt	2 Pcs
3		M6x70mm JCBC Bolt	6 Pcs
4		M6x13mm Lock Washer	8 Pcs
5		M6.5x16.5mm Flat Washer	8 Pcs
6		M4 x 2.1/2" Allen Key	1 Pce
7		Assembly Glue	1 Pce

Important Note

Do not use power tool for assembly.
All bolt must fasten either by wrench or Allen Key.



STEP 2

Do not fully tighten the bolt

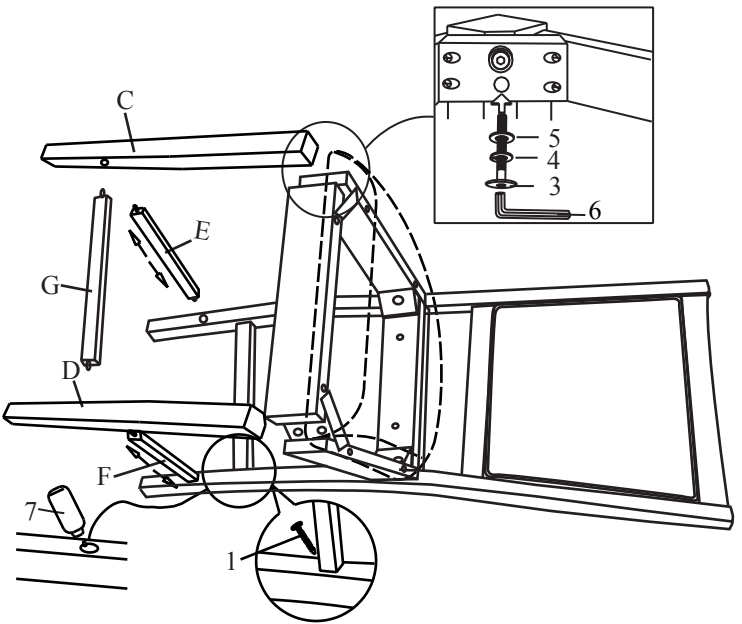

STEP 1

Do not fully tighten the bolt

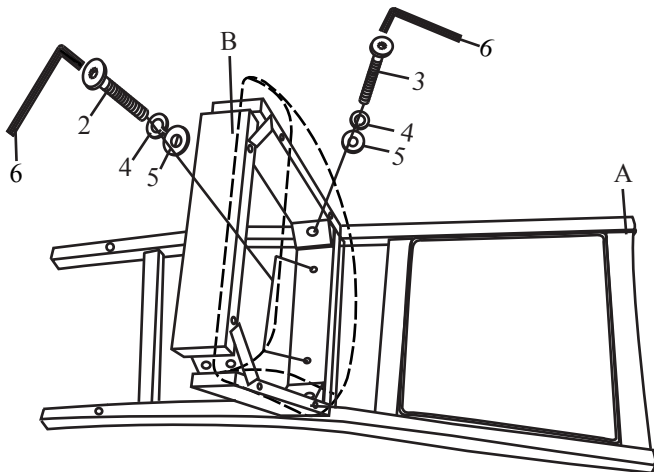

STEP 3

Levelling solution: Loosen each bolt in the seat box (front legs, back corner blocks and back apron) to the point where it can be turned with our fingers. Place the Chair/Stool upright on the floor and make sure Chair/Stool back and seat frame are well connected. Sit in the Chair/Stool, but do not lean against the Chair/Stool back. Gently sway back and forth, left and right. Carefully turn the Chair/Stool upside down, and tighten each bolt. The Chair/Stool will now be levelled.

